

FUJIFILM

BL04801-100 **EN**

DIGITAL CAMERA

X30

Owner's Manual (Basic Operations)

Thank you for your purchase of this product.

■ **Product website:**

<http://fujifilm-x.com/x30/>

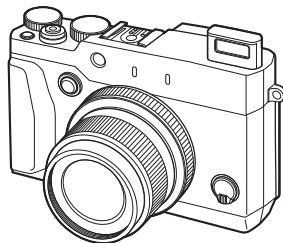

Before You Begin

First Steps

Basic Photography
and Playback

Parts of the Camera

Menus

Appendix

For Your Safety

■ **Product manuals:**

<http://fujifilm-dsc.com/manuals/>



Before You Begin

Supplied Accessories

The following items are included with the camera:



NP-95 rechargeable battery



AC-5VT AC power adapter



*Plug adapter**

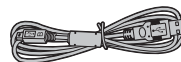

USB cable

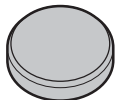

Lens cap



Clip attaching tool



Metal strap clips (x2)

- *Protective covers (x 2)*
- *Shoulder strap*
- *Owner's Manual (this manual)*

* Shape of adapter varies with region of sale.

About This Manual

Symbols and Conventions

The following symbols are used in this manual:

- ⓘ This information should be read before use to ensure correct operation.
- ◆ Additional information that may be helpful when using the camera.

Memory Cards

Pictures are stored on optional SD, SDHC, and SDXC memory cards, referred to in this manual as “memory cards.”

Product Care

For continued enjoyment of your camera, use a soft, dry cloth to clean the camera body after each use. Do not use alcohol, thinner, or other volatile chemicals, which could discolor or deform the leather on the camera body. Any liquid on the camera should be removed immediately with a soft, dry cloth. Use a blower to remove dust from the monitor, taking care to avoid scratches, and then gently wipe with a soft, dry cloth. Any remaining stains can be removed by wiping gently with a piece of FUJIFILM lens-cleaning paper to which a small amount of lens-cleaning fluid has been applied.

Table of Contents

Before You Begin	
Supplied Accessories	2
About This Manual	3
Symbols and Conventions	3
Memory Cards	3
Product Care	4
First Steps	
Attaching the Strap	6
Inserting the Battery and a Memory Card	8
Charging the Battery	10
Turning the Camera on and Off	13
Basic Setup	14
Basic Photography and Playback	
Taking Photographs	16
Viewing Pictures	18
Viewing Pictures Full Frame	18
Viewing Photo Information	19
Playback Zoom	20
Multi-Frame Playback	21
Deleting Pictures	22
FRAME	22
SELECTED FRAMES	23
ALL FRAMES	23
Basic Movie Recording and Playback	24
Recording High-Definition (HD) Movies	24
Viewing Movies	24
Viewing Pictures on a Computer	25
Parts of the Camera	
Parts of the Camera	26
The Selector	28

The Mode dial	28
The Command Dial	29
The Control Ring	29
The VIEW MODE Button	30
The LCD Monitor	31
Diopter Adjustment	31
The Indicator Lamp	31
Camera Displays	32
Shooting: LCD Monitor/Viewfinder	32
Playback	34
Menus	
Using the Menus: Shooting Mode	36
Using the Shooting Menu	36
Shooting Menu Options	37
Using the Menus: Playback Mode	39
Using the Playback Menu	39
Playback Menu Options	40
The Setup Menu	41
Using the Setup Menu	41
Setup Menu Options	42
Appendix	
FUJIFILM X30 Product Information	44
Free FUJIFILM Apps	44
Caring for the Camera	45
Storage and Use	45
Traveling	45
For Your Safety	
IMPORTANT SAFETY INSTRUCTIONS	46
Safety Notes	47
NOTICES	51

First Steps

Attaching the Strap

Attach the strap clips to the camera and then attach the strap.

1 Open a strap clip.

Use the clip attaching tool to open a strap clip, making sure that the tool and clip are in the orientations shown.

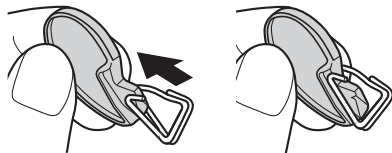

- ① Keep the tool in a safe place. You will need it to open the strap clips when removing the strap.

2 Place the strap clip on an eyelet.

Hook the strap eyelet in the clip opening. Remove the tool, using the other hand to keep the clip in place.

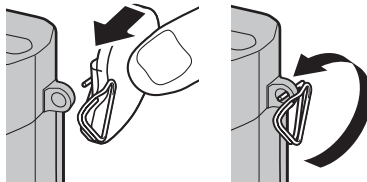

3 Pass the clip through the eyelet.

Rotate the clip fully through the eyelet until it clicks closed.

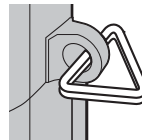

4 Attach a protective cover.

Place a protective cover over the eyelet as shown, with the black side of the cover toward the camera. Repeat Steps 1–4 for the second eyelet.

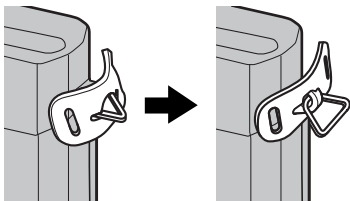

5 Insert the strap.

Insert the strap through a protective cover and strap clip.

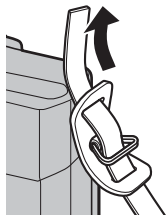

6 Fasten the strap.

Fasten the strap as shown. Repeat Steps 5–6 for the second eyelet.

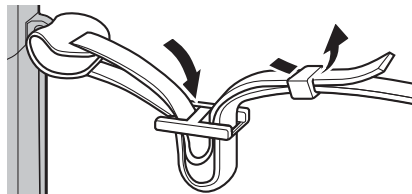

- ⓘ To avoid dropping the camera, be sure the strap is correctly secured.

Inserting the Battery and a Memory Card

Insert the battery and memory card as described below.

1 Open the battery-chamber cover.

Slide the battery-chamber latch as shown and open the battery-chamber cover.

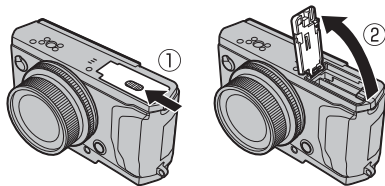

- Ⓛ Do not open the battery-chamber cover when the camera is on. Failure to observe this precaution could damage image files or memory cards.
- Ⓛ Do not use excessive force when handling the battery-chamber cover.

2 Insert the battery.

Using the battery to keep the battery latch pressed to one side, insert the battery contacts first in the direction shown by the arrow. Confirm that the battery is securely latched.

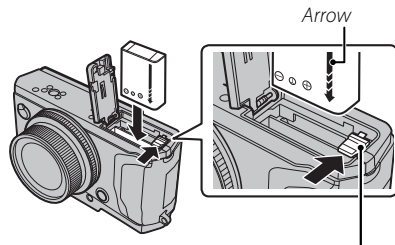



Battery latch

- Ⓛ Insert the battery in the orientation shown. **Do not use force or attempt to insert the battery upside down or backwards.** The battery will slide in easily in the correct orientation.

3 Insert the memory card.

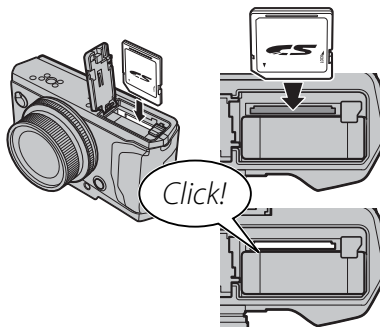
Holding the memory card in the orientation shown, slide it in until it clicks into place at the back of the slot.



- ① Be sure card is in the correct orientation; do not insert at an angle or use force. If the memory card is not correctly inserted or no memory card is inserted,  will appear in the LCD monitor and internal memory will be used for recording and playback.

4 Close the battery-chamber cover.

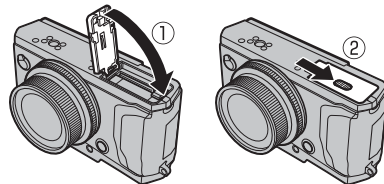

Removing the Battery and Memory Card

Before removing the battery or memory card, **turn the camera off** and open the battery-chamber cover.

To remove the battery, press the battery latch to the side, and slide the battery out of the camera as shown.

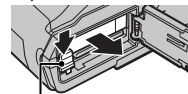

Battery latch

To remove the memory card, press it in and release it slowly. The card can then be removed by hand. When a memory card is removed, the card could come out of the slot too quickly. Use your finger to hold it and gently release the card.

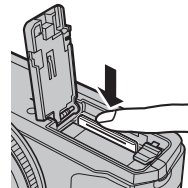

Charging the Battery

The battery is not charged at shipment. Charge the battery before use. The camera charges the battery internally.

- The camera uses an NP-95 rechargeable battery.
- The battery takes about 4 hours and 30 minutes to fully charge.

1 Attach the plug adapter to the AC power adapter.

Attach the plug adapter as shown, making sure that it is fully inserted and clicks into place on the AC power adapter terminals.

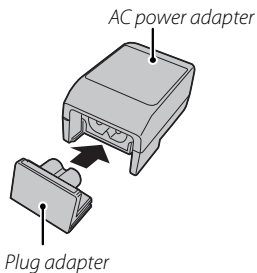

- ① The plug adapter is exclusively for use with the supplied AC power adapter. Do not use it with other devices.

2 Charge the battery.

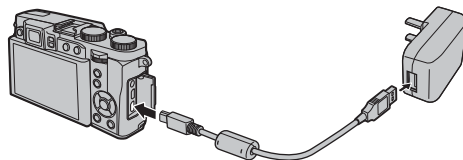

Connect the camera to the supplied AC power adapter using the supplied USB cable. Then plug the AC power adapter into an indoor power outlet.



- ① Be sure the connectors are in the correct orientation and then insert them fully.

Charge status

The battery status icons show battery charge status when the camera is turned on, and the indicator lamp shows it when the camera is turned off.

Battery status icon when camera on	Indicator lamp when camera off	Battery status
 (yellow)	On	Battery charging.
 (green)	Off	Charging complete.
 (red)	Blinks	Battery fault.
No icon	—	Operating in external power mode.

- ◆ The camera operates in external power mode if the camera is turned on while the camera is connected to AC power and the battery is inserted.
- ① The battery will not charge while the camera is in the shooting mode.
- ① Remove dirt from the battery terminals with a clean, dry cloth. Failure to observe this precaution could prevent the battery from charging.
- ① Do not affix stickers or other objects to the battery. Failure to observe this precaution could make it impossible to remove the battery from the camera.
- ① Do not short the battery terminals. The battery could overheat.
- ① Read the cautions in “The Battery and Power Supply”.
- ① Use only battery chargers designated for use with the battery. Failure to observe this precaution could result in product malfunction.
- ① Do not remove the labels from the battery or attempt to split or peel the outer casing.
- ① The battery gradually loses its charge when not in use. Charge the battery one or two days before use.
- ① Charging times may increase at very low or very high temperatures.

Charging via a computer

The battery can be charged by connecting the camera to a computer. Connect the supplied USB cable as shown, making sure the connectors are fully inserted.

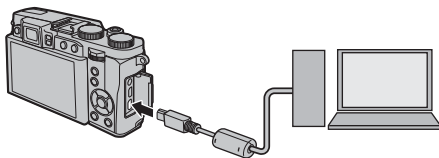



- ⓘ Connect the camera directly to the computer; do not use a USB hub or keyboard.
- ⓘ If the computer goes into sleep mode while charging, charging will stop. To continue charging, disable sleep mode on the computer, and disconnect and connect the USB cable.
- ⓘ Charging may be impossible depending on computer specifications, settings or conditions.

Turning the Camera on and Off

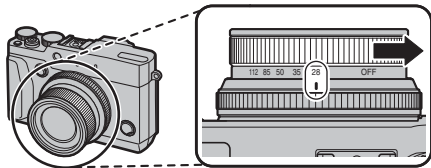
To turn the camera on, rotate the zoom ring as shown. Rotate the zoom ring to **OFF** to turn the camera off.



- ◆ Press the  button to start playback. Press the shutter button halfway to return to shooting mode.
- ◆ The camera will turn off automatically if no operations are performed for the length of time selected for  **POWER MANAGEMENT > AUTO POWER OFF** in the setup menu. To reactivate the camera after it has turned off automatically, rotate the zoom ring to **OFF** and then turn the camera on.
- ⓘ Fingerprints and other marks on the lens or viewfinder can affect pictures or the view through the viewfinder. Keep the lens and viewfinder clean.

Turning the Camera on in Playback Mode

To turn the camera on and begin playback, press the  button for about a second.

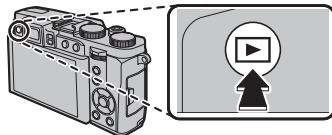



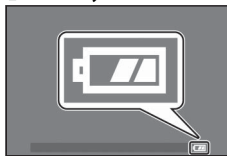

Press the  button again to turn the camera off.

- ⓘ The camera does not exit to shooting mode when pressing the shutter button.

Battery Level



After turning the camera on, check the battery level in the display.

Indicator	Description
	Battery close to fully charged.
	Battery about two-thirds charged.
	Battery about one-third charged. Charge as soon as possible.
 (red)	Battery exhausted. Turn camera off and recharge battery.

Basic Setup

A language-selection dialog is displayed the first time the camera is turned on. Set up the camera as described below (you can reset the clock or change languages at any time using the **🕒 DATE/TIME** or **🗨️ 言語/LANG.** options in the setup menu).

Using the Selector

Press the selector up, down, left, or right to highlight items and press **MENU/OK** to select.

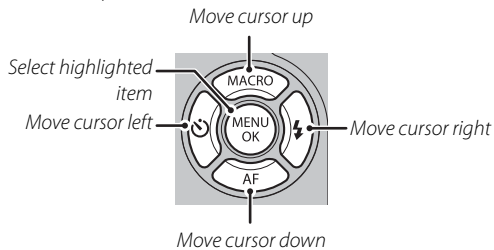

- 1 Turn the camera on.

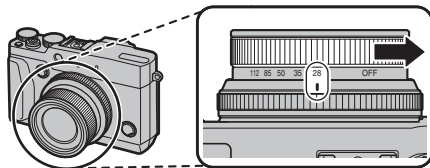

- 2 Highlight a language and press **MENU/OK**.

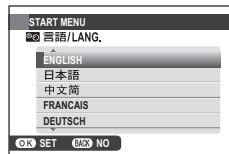

- ◆ Press **DISP/BACK** to skip the current step. Any steps you skip will be displayed the next time the camera is turned on.

3 The date and time will be displayed. Press the selector left or right to highlight the year, month, day, hour, or minute and press up or down to change. To change the order in which the year, month, and day are displayed, highlight the date format and press the selector up or down. Press **MENU/OK** when settings are complete.

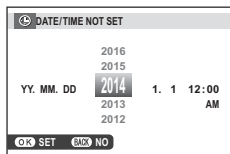

4 Power management options will be displayed. Press the selector up or down to highlight one of the following options and then press **MENU/OK**:

- **POWER SAVE:** Save battery power.
 - **HIGH PERFORMANCE:** Choose for a brighter display and faster focus.
- ☛ If the battery is removed for an extended period, the camera clock will be reset and the language-selection dialog will be displayed when the camera is turned on.

Basic Photography and Playback

Taking Photographs

This section covers the basics of taking pictures in **SR+** (**ADVANCED SR AUTO**) mode.

1 Select **SR+** mode.

Rotate the mode dial to **SR+** (**ADVANCED SR AUTO**). The following information will be displayed in the LCD monitor.

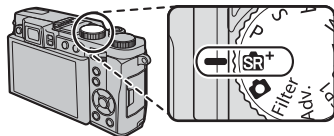

Scene Icon

The camera automatically selects the appropriate scene.

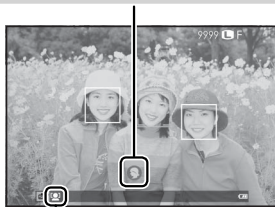

The Icon

In **SR+** mode, the camera continuously adjusts focus and searches for faces, increasing the drain on the battery.  is displayed in the LCD monitor.

Using the Flash

To raise the flash when lighting is poor, press the flash pop-up switch.

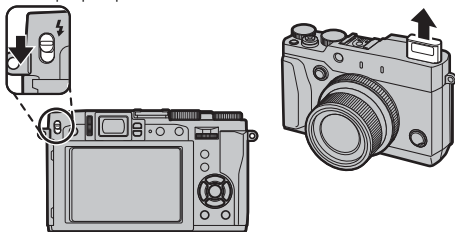

2 Ready the camera.

Hold the camera steady with both hands and brace your elbows against your sides. Shaking or unsteady hands can blur your shots.



To prevent pictures that are out of focus or too dark (underexposed), keep your fingers and other objects away from the lens and flash.

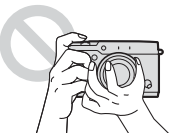

3 Frame the picture.

Use the zoom ring to frame the picture in the display. The zoom indicator appears.

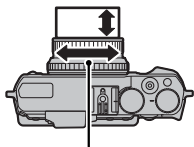

Zoom ring

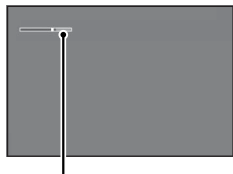

Zoom indicator

4 Focus.

Frame the picture with your subject in the center of the display and press the shutter button halfway to focus.



❖ If the subject is poorly lit, the AF-assist illuminator may light.

If the camera is able to focus, it will beep twice and focus area and focus indicator will glow green. Focus and exposure will lock while the shutter button is pressed halfway.

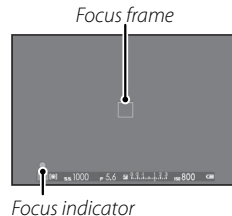

If the camera is unable to focus, the focus frame will turn red, **!AF** will be displayed, and the focus indicator will blink white.

5 Shoot.

Smoothly press the shutter button the rest of the way down to take the picture.



Viewing Pictures

Viewing Pictures Full Frame

To view pictures full frame, press .

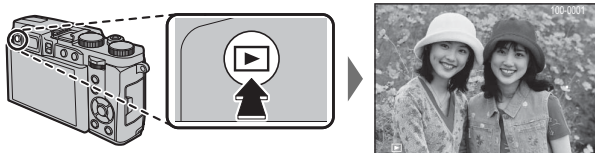

Additional pictures can be viewed by pressing the selector left or right or rotating the command dial. Press the selector or rotate the dial right to view pictures in the order recorded, left to view pictures in reverse order. Keep the selector pressed to scroll rapidly to the desired frame.

◆ Pictures taken using other cameras are indicated by a  ("gift image") icon during playback.

Favorites: Rating Pictures

To rate the current picture, press **DISP/BACK** and press the selector up and down to select from zero to five stars.

Viewing Photo Information

The photo information display changes each time the selector is pressed up.

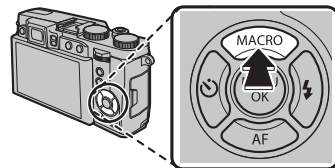

- Press the selector left or right or rotate the command dial to view other images.

Zooming in on the Focus Point

Press the center of the command dial to zoom in on the focus point. Press the center of the command dial again to return to full-frame playback.



Playback Zoom

Rotate the control ring right to zoom in on the current picture, left to zoom out (to view multiple images, rotate the control ring left when the picture is displayed full frame). Press **DISP/BACK** or **MENU/OK** to exit zoom.

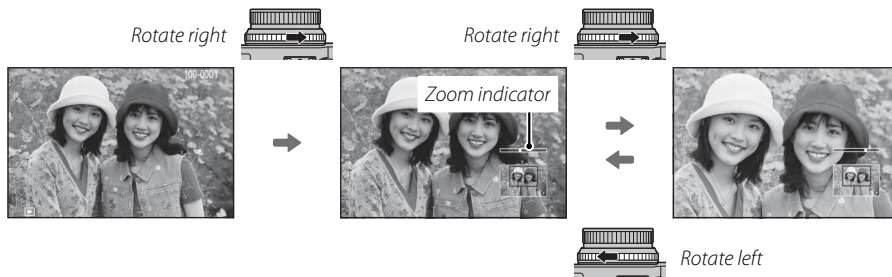
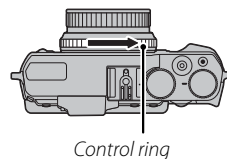

- ◆ The maximum zoom ratio varies with image size. Playback zoom is not available with cropped or resized copies saved at a size of **640**.

The Navigation Window

Navigation window shows portion of image currently displayed

When the picture is zoomed in, the selector can be used to view areas of the image not currently visible in the display.

Multi-Frame Playback

To change the number of images displayed, rotate the control ring left when a picture is displayed full frame.

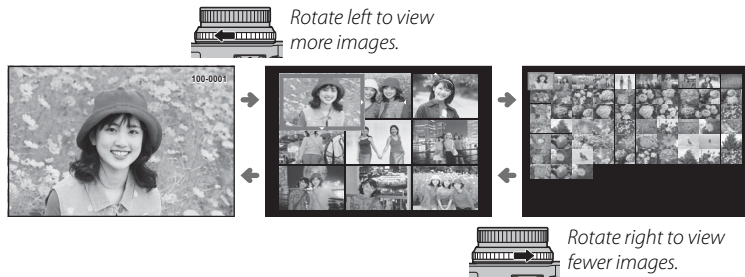
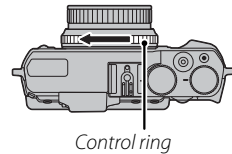

Use the selector to highlight images and press **MENU/OK** to view the highlighted image full frame (to zoom in on the selected image, rotate the control ring right when the picture is displayed full frame). In the nine- and hundred-frame displays, press the selector up or down to view more pictures.

Deleting Pictures

To delete individual pictures, multiple selected pictures, or all pictures, press the  button when a picture is displayed full frame and choose from the options on the following pages. *Note that deleted pictures can not be recovered. Copy important pictures to a computer or other storage device before proceeding.*

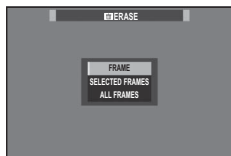
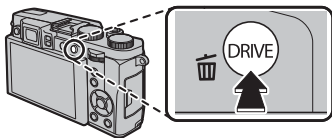

- ❖ Protected pictures can not be deleted. Remove protection from any pictures you wish to delete.
- ❖ If a message appears stating that the selected images are part of a DPOF print order, press **MENU/OK** to delete the pictures.
- ❖ If a memory card is inserted, pictures will be deleted from the memory card. Otherwise pictures will be deleted from internal memory.



FRAME

Delete pictures one at a time.

- 1 Press the  button in full-frame playback and select **FRAME**.
- 2 Press the selector left or right to scroll through pictures and press **MENU/OK** to delete (a confirmation dialog is not displayed). Repeat to delete additional pictures.

SELECTED FRAMES

Delete multiple selected pictures.

- 1 Press the  button in full-frame playback and choose **SELECTED FRAMES**.
- 2 Highlight pictures and press **MENU/OK** to select or deselect (pictures in photobooks or print orders are shown by .
- 3 When the operation is complete, press **DISP/BACK** to display a confirmation dialog.
- 4 Highlight **OK** and press **MENU/OK** to delete the selected pictures.

ALL FRAMES

Delete all unprotected pictures.

- 1 Press the  button in full-frame playback and choose **ALL FRAMES**.
- 2 A confirmation dialog will be displayed; highlight **OK** and press **MENU/OK** to delete all unprotected pictures. Pressing **DISP/BACK** cancels deletion; note that any pictures deleted before the button was pressed can not be recovered.

Basic Movie Recording and Playback

Recording High-Definition (HD) Movies

The camera can be used to record short high-definition movies.

- 1 Press the movie-record button to start recording.

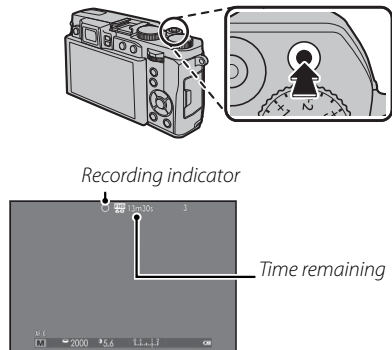

- 2 Press the button again to end recording. Recording ends automatically when the maximum length is reached or the memory card is full.

- ⓘ The indicator lamp lights while movies are being recorded.

Viewing Movies

During playback, movies are displayed as shown at right. The following operations can be performed while a movie is displayed:

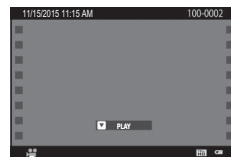

Movie icon

Operation	Description
Start/pause playback	Press the selector down to start playback. Press again to pause. While playback is paused, you can press the selector left or right to rewind or advance one frame at a time.
End playback	Press the selector up to end playback.
Adjust speed	Press the selector left or right to adjust playback speed during playback.

Viewing Pictures on a Computer

Connect the camera using the supplied USB cable and copy pictures to the computer.

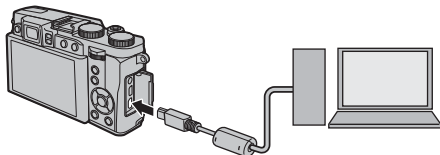

① Connect the camera directly to the computer; do not use a USB hub or keyboard.

Windows

- MyFinePix Studio (available for download from the website below) can be used to copy pictures to a computer, where they can be stored, viewed, organized, and printed.

<http://fujifilm-dsc.com/mfs/>

- RAW FILE CONVERTER (available for download from the website below) can be used to view RAW images on your computer.

<http://fujifilm-dsc.com/rfc/>

Mac OS

RAW FILE CONVERTER (available for download from the website below) can be used to view RAW images on your computer.

<http://fujifilm-dsc.com/rfc/>

Parts of the Camera

Parts of the Camera

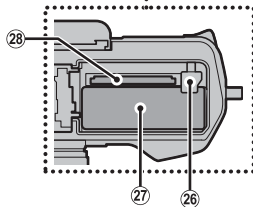
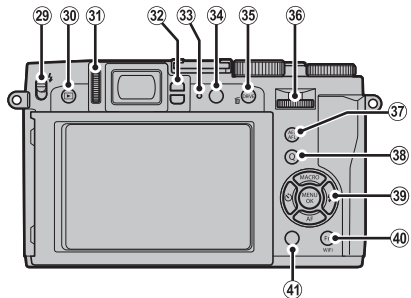
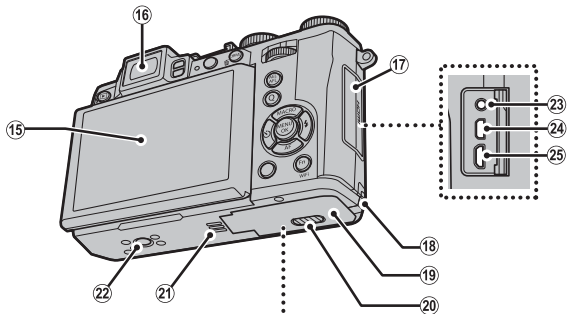
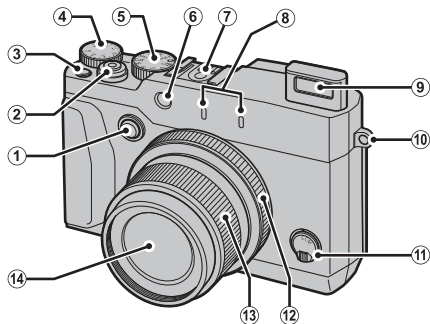

- ① Control ring options button
- ② Shutter button
- ③ Movie-record button (function button 1)
- ④ Exposure compensation dial
- ⑤ Mode dial
- ⑥ AF-assist illuminator
Self-timer lamp
- ⑦ Hot shoe
- ⑧ Microphone (L/R)
- ⑨ Flash
- ⑩ Strap eyelet
- ⑪ Focus mode selector
- ⑫ Control ring
- ⑬ Zoom ring
ON/OFF switch
- ⑭ Lens
- ⑮ Monitor
- ⑯ Electronic viewfinder (EVF)
- ⑰ Terminal cover
- ⑱ DC coupler cable cover
- ⑲ Battery chamber cover
- ⑳ Battery-chamber cover latch
- ㉑ Speaker
- ㉒ Tripod mount
- ㉓ Microphone/remote release connector
- ㉔ Micro HDMI connector*
- ㉕ Micro USB connector
- ㉖ Battery latch
- ㉗ Battery chamber
- ㉘ Memory card slot
- ㉙ ⚡ (flash pop-up) switch
- ㉚ ▶ (playback) button
- ㉛ Diopter adjustment control
- ㉜ Eye sensor
- ㉝ Indicator lamp
- ㉞ **VIEW MODE** button
- ㉟ **DRIVE** button
- ⏏ (delete) button (playback mode)
- ㊱ Command dial
- ㊲ **AEL/AFL** (autoexposure/autofocus lock) button
- ㊳ **Q** (quick menu) button
RAW conversion button (playback mode)
- ㊴ Selector/function buttons
- ㊵ **Fn** button (function button 6)
Wi-Fi button (playback mode)
- ㊶ **DISP** (display)/**BACK** button

* Use an HDMI cable no more than 1.5 m (4.9 ft.) long.

The Selector

Press the selector up (②), left (③), right (④), or down (⑤) to highlight items and press **MENU/OK** (①) to select. The up, left, right, and down buttons also double as function buttons 2 through 5.

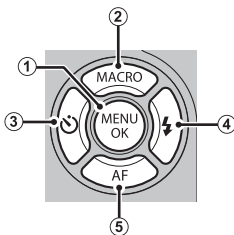
**The Mode dial**

To choose a shooting mode, rotate the mode dial to the desired setting.



- **SR+ (ADVANCED SR AUTO):** The camera automatically optimizes settings to the scene.
- **📷 (AUTO):** A simple “point-and-shoot” mode recommended for first-time users of digital cameras.
- **P:** Aperture and shutter speed can be adjusted using program shift.
- **S, A, M:** Select for full control over camera settings, including aperture (**M** and **A**) and/or shutter speed (**M** and **S**).
- **Filter (ADVANCED FILTER):** Select for taking photos with filter effects.
- **Adv. (ADVANCED):** Sophisticated techniques made easy.
- **SP1/SP2 (SCENE POSITION):** Choose a scene suited to the subject or shooting conditions and let the camera do the rest.
- **📐 (MOTION PANORAMA 360):** Pan the camera to take a series of shots that are automatically joined into a panorama.

The Command Dial

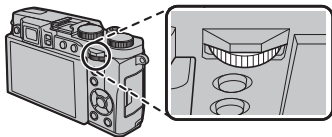

The command dial can be used to navigate the menus, to view pictures, and to select options in the quick menu display.



Press the center of the command dial to zoom in on the active focus area during shooting or playback.



The Control Ring

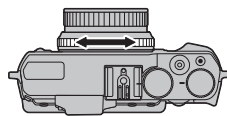

Use the control ring for quick access to camera functions during shooting. The function assigned to the control ring can be selected by pressing the control ring options button. Choose from:



- DEFAULT
- ISO
- WHITE BALANCE
- FILM SIMULATION
- CONTINUOUS

"DEFAULT"

When **DEFAULT** is selected, the function assigned to the control ring changes with the shooting mode.

Mode	Control ring used for
 SR+	Film simulation
	Film simulation; manual focus ¹
P	Program shift; manual focus ¹
S	Shutter-speed selection; manual focus ¹
A	Aperture selection; manual focus ¹
M	Shutter-speed/aperture selection ² ; manual focus ¹
Filter	Advanced filter selection
Adv.	Advanced mode selection
SP1/SP2	Scene selection; manual focus ¹

¹ Manual focus mode only

² Press the control ring options button to switch between shutter-speed and aperture selection.

The VIEW MODE Button

Press the **VIEW MODE** button to cycle through displays as shown below.

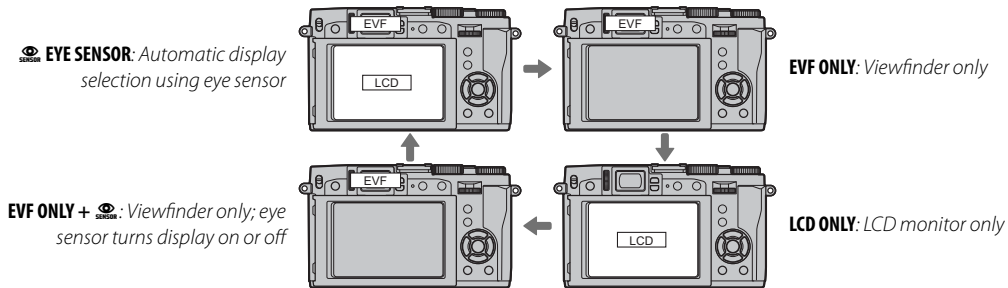
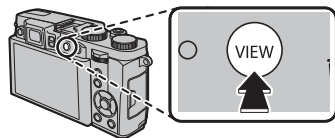

The Eye Sensor

The eye sensor turns the viewfinder on when you put your eye to the viewfinder and turns it off when you take your eye away (note that the eye sensor may respond to objects other than your eye or to light shining directly on the sensor). If automatic display selection is enabled, the LCD monitor will turn on when the viewfinder turns off.

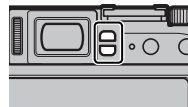

The LCD Monitor

The LCD monitor can be tilted for easier viewing, but be careful not to touch the wires or trap fingers or other objects behind the monitor. Touching the wires could cause camera malfunction.

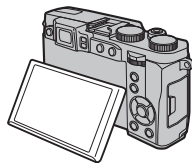
**Diopter Adjustment**

The camera is equipped with diopter adjustment to accommodate individual differences in vision. Rotate the diopter adjustment control until the viewfinder display is in sharp focus.

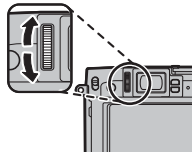
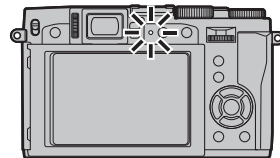
**The Indicator Lamp**

The indicator lamp shows camera status as follows:

Indicator lamp	Camera status
Glows green	Focus locked.
Blinks green	Blur, focus, or exposure warning. Picture can be taken.
Blinks green and orange	Recording pictures. Additional pictures can be taken.
Glows orange	Recording pictures. No additional pictures can be taken at this time.
Blinks orange (Fast)	Flash charging; flash will not fire when picture is taken.
Blinks orange (Slow)	The zoom ring is positioned between ON and OFF. Pictures cannot be taken.
Blinks red	Lens or memory error.

◆ Warnings may also appear in the display.

Camera Displays

The following types of indicator may be displayed during shooting and playback. In the description that follows, all available indicators are shown for illustrative purposes; the indicators actually displayed vary with camera settings.

■ Shooting: LCD Monitor/Viewfinder

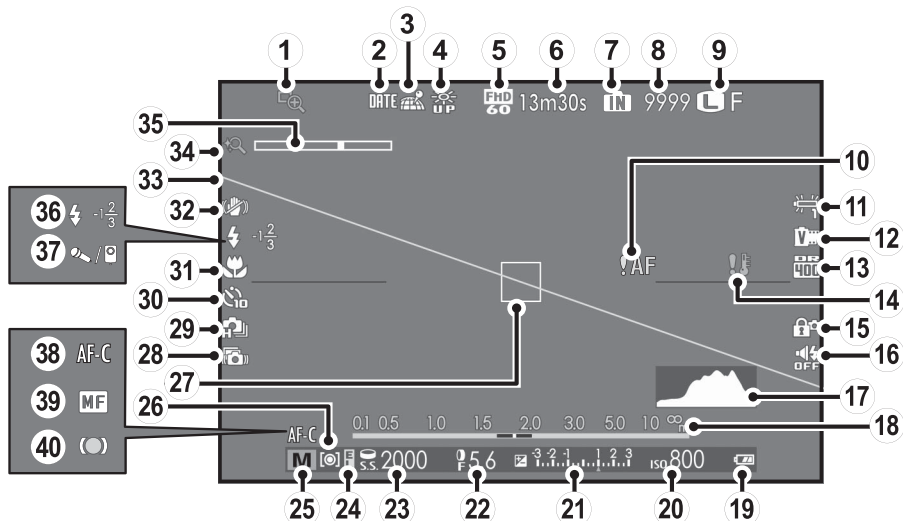

* : indicates that no memory card is inserted and that pictures will be stored in the camera's internal memory.

- ① Focus check
- ② Date stamp
- ③ Location data download status
- ④ Monitor sunlight mode
- ⑤ Movie mode
- ⑥ Time remaining
- ⑦ Internal memory indicator*
- ⑧ Number of available frames
- ⑨ Image size/quality
- ⑩ Focus warning
- ⑪ White balance
- ⑫ Film simulation
- ⑬ Dynamic range
- ⑭ Temperature warning
- ⑮ Control lock
- ⑯ Silent mode indicator
- ⑰ Histogram
- ⑱ Distance indicator
- ⑲ Battery level
- ⑳ Sensitivity
- ㉑ Exposure indicator
- ㉒ Aperture
- ㉓ Shutter speed
- ㉔ AE lock indicator
- ㉕ Shooting mode
- ㉖ Metering
- ㉗ Focus frame
- ㉘ Advanced Anti Blur
- ㉙ Continuous mode
- ㉚ Self-timer indicator
- ㉛ Macro (close-up) mod
- ㉜ Dual IS mode
- ㉝ Electronic level
- ㉞ Intelligent digital zoom
- ㉟ Zoom indicator
- ㊱ Flash mode/Flash compensation
- ㊲ Microphone/remote release
- ㊳ Focus mode
- ㊴ Manual focus indicator
- ㊵ Focus indicator

Display Selection

Press the **DISP/BACK** button to choose the information displayed in the monitor and electronic viewfinder.

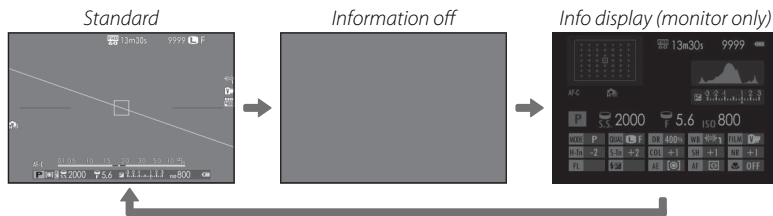

■ Playback

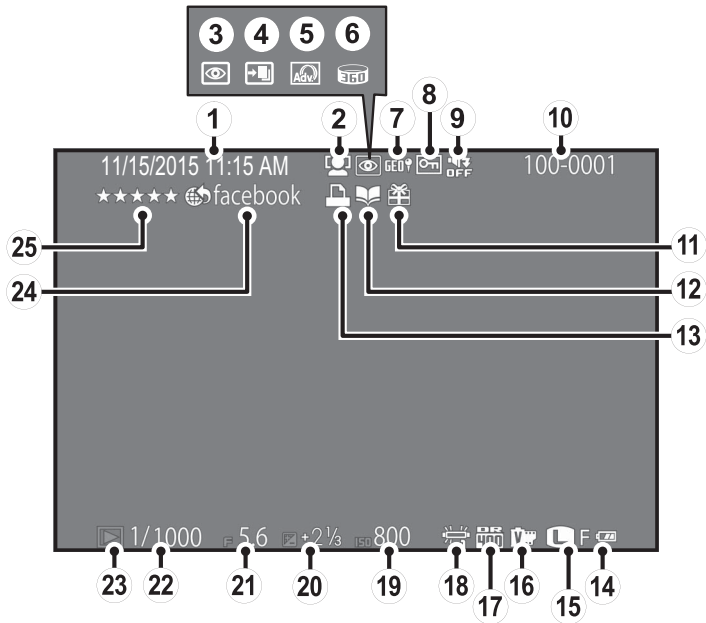

- ① Date and time
- ② Intelligent face detection indicator
- ③ Red-eye removal indicator
- ④ Pro focus mode, pro low-light mode
- ⑤ Advanced filter
- ⑥ Motion panorama 
- ⑦ Location data
- ⑧ Protected image
- ⑨ Silent mode indicator
- ⑩ Frame number
- ⑪ Gift image
- ⑫ Photobook assist
- ⑬ DPOF print indicator
- ⑭ Battery level
- ⑮ Image size/quality
- ⑯ Film simulation
- ⑰ Dynamic range
- ⑱ White balance
- ⑲ Sensitivity
- ⑳ Exposure compensation
- ㉑ Aperture
- ㉒ Shutter speed
- ㉓ Playback mode indicator
- ㉔ Mark for upload to
- ㉕ Favorites

Display Selection

Press the **DISP/BACK** button to choose the information displayed in playback mode.

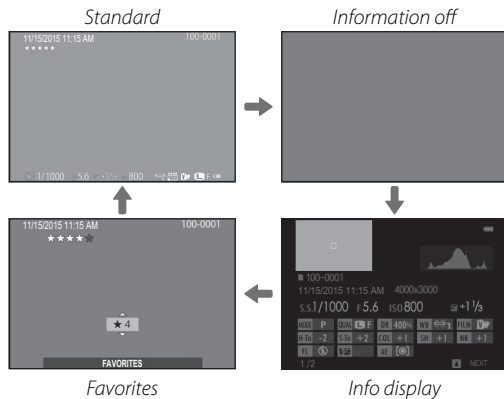

Menus

Using the Menus: Shooting Mode

Use the shooting menus to adjust shooting settings. The options available vary with the shooting mode selected.

Using the Shooting Menu

- 1 Press **MENU/OK** to display the shooting menu.

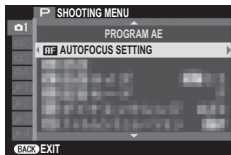

- 2 Press the selector up or down to highlight the desired menu item.

- 3 Press the selector right to display options for the highlighted item.

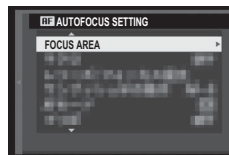

- 4 Press the selector up or down to highlight the desired option.
- 5 Press **MENU/OK** to select the highlighted option.
- 6 Press **DISP/BACK** to exit from the menu.

Shooting Menu Options

SCENE POSITION

Choose a scene for **SP1/SP2** mode.

Adv. MODE

Choose an advanced shooting mode.

ADVANCED FILTER

Choose to take photos with filter effects.

AUTOFOCUS SETTING

Adjust autofocus settings.

ISO

Control the camera's sensitivity to light.

IMAGE SIZE

Choose the size and aspect ratio at which still pictures are recorded.

IMAGE QUALITY

Choose a file format and compression ratio.

DYNAMIC RANGE

Control contrast.

FILM SIMULATION

Simulate the effects of different types of film.

FILM SIMULATION BKT

Choose film types for film simulation bracketing.

SELF-TIMER

Take pictures with the self-timer.

INTERVAL TIMER SHOOTING

Adjust settings for interval timer photography.

WHITE BALANCE

Adjust colors to match the light source.

COLOR

Adjust color density.

SHARPNESS

Sharpen or soften outlines.

HIGHLIGHT TONE

Adjust the appearance of highlights.

SHADOW TONE

Adjust the appearance of shadows.

NOISE REDUCTION

Reduce noise in pictures taken at high sensitivities.

INTELLIGENT DIGITAL ZOOM

Intelligent digital zoom magnifies the image while processing it for sharp, high-resolution results.

ADVANCED ANTI BLUR

Select **ON** to enable advanced anti blur in **Sr+** mode.

SELECT CUSTOM SETTING

Recall settings saved with  **EDIT/SAVE CUSTOM SETTING**.

EDIT/SAVE CUSTOM SETTING

Save settings.



FACE DETECTION

Choose whether the camera automatically detects and sets focus and exposure for human portrait subjects.

PHOTOMETRY

Choose how the camera measures the brightness of the subject.

INTERLOCK SPOT AE & FOCUS AREA

Choose whether the camera meters the current focus frame when  **SPOT** is selected for  **PHOTOMETRY**.

MF ASSIST

Choose how focus is displayed in manual focus mode.

CONTROL RING SETTING

Set functions assigned to the control ring.

FLASH SET-UP

Choose a flash mode and flash level.

MOVIE SET-UP

Adjust movie settings.

WIRELESS COMMUNICATION

Connect to a smartphone or tablet over a wireless network.

Using the Menus: Playback Mode

Using the Playback Menu

- 1 Press the **▶** button to enter playback mode.
- 2 Press **MENU/OK** to display the playback menu.

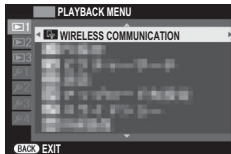

- 3 Press the selector up or down to highlight the desired menu item.
- 4 Press the selector right to display options for the highlighted item.

- 5 Press the selector up or down to highlight the desired option.
- 6 Press **MENU/OK** to select the highlighted option.
- 7 Press **DISP/BACK** to exit from the menu.

Playback Menu Options

WIRELESS COMMUNICATION

Connect to a smartphone or tablet over a wireless network.

PC AUTO SAVE

Upload pictures to a computer over a wireless network.

IMAGE SEARCH

Search for pictures.

ERASE

Delete pictures.

MARK FOR UPLOAD TO

Select pictures for upload to YouTube, Facebook or MyFinePix.com using MyFinePix Studio (Windows only).

SLIDE SHOW

View pictures in an automated slide show.

RAW CONVERSION

Create JPEG copies of RAW pictures.

RED EYE REMOVAL

Remove red-eye from portraits.

PROTECT

Protect pictures from accidental deletion.

CROP

Create a cropped copy of the current picture.

RESIZE

Create a cropped copy of the current picture.

IMAGE ROTATE

Rotate pictures.

COPY COPY

Copy pictures from internal memory to a memory card.

PHOTOBOOK ASSIST

Create books from your favorite photos.

PRINT ORDER (DPOF)

Select pictures for printing on DPOF- and PictBridge-compatible devices.

instax PRINTER PRINT

Print pictures on optional FUJIFILM instax SHARE printers.

DISP ASPECT

Choose how High Definition (HD) devices display pictures with an aspect ratio of 3:2.

The Setup Menu

Using the Setup Menu

1 Display the setup menu.

- 1.1 Press **MENU/OK** to display the menu for the current mode.
- 1.2 Press the selector left to highlight the tab for the current menu.

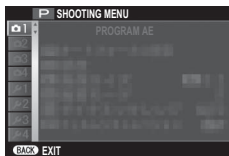

- 1.3 Press the selector down to highlight the setup menu tab containing the desired option.



- 1.4 Press the selector right to place the cursor in the setup menu.

2 Adjust settings.

- 2.1 Press the selector up or down to highlight a menu item.

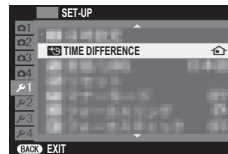

- 2.2 Press the selector right to display options for the highlighted item.



- 2.3 Press the selector up or down to highlight an option.
- 2.4 Press **MENU/OK** to select the highlighted option.
- 2.5 Press **DISP/BACK** to exit from the menu.

Setup Menu Options

DATE/TIME

Set the camera clock.

TIME DIFFERENCE

Switch the camera clock instantly from your home time zone to the local time at your destination when traveling.

言語/LANG.

Choose a language.

RESET

Reset shooting or setup menu options to default values.

SILENT MODE

Disable the speaker, flash, illuminator, and self-timer lamp in situations in which camera sounds or lights may be unwelcome.

CONTROL RING

Choose the direction in which the control ring is rotated to increase the focus distance in manual focus mode.

FOCUS CHECK

The image will be magnified in the display to assist focus when the control ring is rotated in manual focus mode.

SOUND SET-UP

Adjust sound settings.

SCREEN SET-UP

Adjust display settings.

FUNCTION (Fn) SETTING

Choose the roles played by the function buttons.

SELECTOR BUTTON SETTING

Choose the roles played by the buttons on the selector.

EDIT/SAVE QUICK MENU

Choose the options displayed in the quick menu.

POWER MANAGEMENT

Adjust power management settings.

IS MODE

Reduce camera and subject blur.

RED EYE REMOVAL

Remove red-eye effects caused by the flash.

AE-L AE/AF-LOCK MODE

Choose the role played by the **AE/L** button.

AE/L AE/AF-LOCK BUTTON

Choose whether the **AE/L** button locks only exposure, only focus, or both exposure and focus.

SAVE DATA SET-UP

Adjust file management settings.

FOCUS SCALE UNITS

Choose the units used for the focus distance indicator.

WIRELESS SETTINGS

Adjust settings for connection to wireless networks.

PC AUTO SAVE SETTING

Choose an upload destination.

GEOTAGGING SET-UP

View location data downloaded from a smartphone and choose whether to save the data with your pictures.

instax PRINTER CONNECTION SETTING

Adjust settings for connection to optional FUJIFILM instax SHARE printers.

EDIT FILE NAME

Change the file name prefix.

FORMAT

If a memory card is inserted in the camera, this option will format the memory card. If no memory card is inserted, this option will format internal memory.

Appendix

For more information on FUJIFILM digital camera, visit the websites listed below.

FUJIFILM X30 Product Information

Optional accessories and support information can be found on the following website.



Free FUJIFILM Apps

FUJIFILM apps give you more opportunities to enjoy your pictures on smartphones, tablets, and computers.

<http://fujifilm-dsc.com/>



MyFinePix Studio (Windows only) can be used to copy pictures to a computer, where they can be stored, viewed, organized, and printed.

<http://fujifilm-dsc.com/mfs/>



RAW FILE CONVERTER can be used to view RAW images on your computer.

<http://fujifilm-dsc.com/rfc/>



Caring for the Camera

To ensure continued enjoyment of the product, observe the following precautions.

Storage and Use

If the camera will not be used for an extended period, remove the battery and memory card. Do not store or use the camera in locations that are:

- exposed to rain, steam, or smoke
- very humid or extremely dusty
- exposed to direct sunlight or very high temperatures, such as in a closed vehicle on a sunny day
- extremely cold
- subject to strong vibration
- exposed to strong magnetic fields, such as near a broadcasting antenna, power line, radar emitter, motor, transformer, or magnet
- in contact with volatile chemicals such as pesticides
- next to rubber or vinyl products

■ Water and Sand

Exposure to water and sand can also damage the camera and its internal circuitry and mechanisms. When using the camera at the beach or seaside, avoid exposing the camera to water or sand. Do not place the camera on a wet surface.

■ Condensation

Sudden increases in temperature, such as occur when entering a heated building on a cold day, can cause condensation inside the camera. If this occurs, turn the camera off and wait an hour before turning it on again. If condensation forms on the memory card, remove the card and wait for the condensation to dissipate.

Traveling

Keep the camera in your carry-on baggage. Checked baggage may suffer violent shocks that could damage the camera.

IMPORTANT SAFETY INSTRUCTIONS

- **Read Instructions:** All the safety and operating instructions should be read before the appliance is operated.
- **Retain Instructions:** The safety and operating instructions should be retained for future reference.
- **Heed Warnings:** All warnings on the appliance and in the operating instructions should be adhered to.
- **Follow Instructions:** All operating and use instructions should be followed.

Installation

Power Sources: This video product should be operated only from the type of power source indicated on the marking label. If you are not sure of the type of power supply to your home, consult your appliance dealer or local power company. For video products intended to operate from battery power, or other sources, refer to the operating instructions.

Grounding or Polarization: This video product is equipped with a polarized alternating-current line plug (a plug having one blade wider than the other). This plug will fit into the power outlet only one way. This is a safety feature. If you are unable to insert the plug fully into the outlet, try reversing the plug. If the plug should still fail to fit, contact your electrician to replace your obsolete outlet. Do not defeat the safety purpose of the polarized plug.

Alternate Warnings: This video product is equipped with a three-wire grounding-type plug, a plug having a third (grounding) pin. This plug will only fit into a grounding-type power outlet. This is a safety feature. If you are unable to insert the plug into the outlet, contact your electrician to replace your obsolete outlet. Do not defeat the safety purpose of the grounding-type plug.

Overloading: Do not overload wall outlets and extension cords as this can result in a risk of fire or electric shock.

Ventilation: Slots and openings in the cabinet are provided for ventilation, to ensure reliable operation of the video product and to protect it from overheating, and these openings must not be blocked or covered. The openings should never be blocked by placing the video product on a bed, sofa, rug, or other similar surface.

This video product should not be placed in a built-in installation such as a bookcase or rack unless proper ventilation is provided or the manufacturer's instructions have been adhered to. This video product should never be placed near or over a radiator or heat register.

Attachments: Do not use attachments not recommended by the video product manufacturer as they may cause hazards.

Water and Moisture: Do not use this video product near water—for example, near a bath tub, wash bowl, kitchen sink, or laundry tub, in a wet basement, or near a swimming pool, and the like.

Power-Cord Protection: Power-supply cords should be routed so that they are not likely to be walked on or pinched by items placed upon or against them, paying particular attention to cords at plugs, convenience receptacles, and the point where they exit from the appliance.

Accessories: Do not place this video product on an unstable cart, stand, tripod, bracket, or table. The video product may fall, causing serious injury to a child or adult, and serious damage to the appliance. Use only with a cart, stand, tripod, bracket, or table recommended by the manufacturer, or sold with the video product. Any mounting of the appliance should follow the manufacturer's instructions, and should use a mounting accessory recommended by the manufacturer.

An appliance and cart combination should be moved with care. Quick stops, excessive force, and uneven surfaces may cause the appliance and cart combination to overturn.



Antennas

Outdoor Antenna Grounding: If an outside antenna or cable system is connected to the video product, be sure the antenna or cable system is grounded so as to provide some protection against voltage surges and built-up static charges. Section 810 of the National Electrical Code, ANSI/NFPA No. 70, provides information with respect to proper grounding of the

mast and supporting structure, grounding of the lead-in wire to an antenna discharge unit, size of grounding conductors, location of antenna discharge unit, connection to grounding electrodes, and requirements for the grounding electrode.

EXAMPLE OF ANTENNA GROUNDING AS PER NATIONAL ELECTRICAL CODE

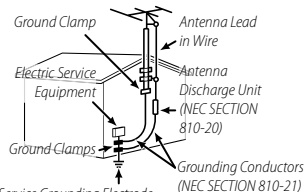

Power Service Grounding Electrode System (NEC ART 250, PART H)

Power Lines: An outside antenna system should not be located in the vicinity of overhead power lines or other electric light or power circuits, or where it can fall into such power lines or circuits. When installing an outside antenna system, extreme care should be taken to keep from touching such power lines or circuits as contact with them might be fatal.

Use

Cleaning: Unplug this video product from the wall outlet before cleaning. Do not use liquid cleaners or aerosol cleaners. Use a damp cloth for cleaning.

Object and Liquid Entry: Never push objects of any kind into this video product through openings as they may touch dangerous voltage points or short out parts that could result in a fire or electric shock. Never spill liquid of any kind on the video product.

Lightning: For added protection for this video product receiver during a lightning storm, or when it is left unattended and unused for long periods of time, unplug it from the wall outlet and disconnect the antenna or cable system. This will prevent damage to the video product due to lightning and power-line surges.

Service

Service: Do not attempt to service this video product yourself as opening or removing covers may expose you to dangerous voltage or other hazards. Refer all servicing to qualified service personnel.

Damage Requiring Service: Unplug this video product from the wall outlet and refer servicing to qualified service personnel under the following conditions:

- When the power-supply cord or plug is damaged
- If liquid has been spilled, or objects have fallen into the video product.
- If the video product has been exposed to rain or water.
- If the video product has been dropped or the cabinet has been damaged.

If the video product does not operate normally follow the operating instructions. Adjust only those controls that are covered by the operating instructions as an improper adjustment of other controls may result in damage and will often require extensive work by a qualified technician to restore the video product to its normal operation.

When the video product exhibits a distinct change in performance—this indicates a need for service.

Replacement Parts: When replacement parts are required, be sure the service technician has used replacement parts specified by the manufacturer or have the same characteristics as the original part. Unauthorized substitutions may result in fire, electric shock or other hazards.



Safety Check: Upon completion of any service or repairs to this video product, ask the service technician to perform safety checks to determine that the video product is in proper operating condition.

Be sure to read these notes before use**Safety Notes**



- Make sure that you use your camera correctly. Read these safety notes and your *Owner's Manual* carefully before use.
- After reading these safety notes, store them in a safe place.

About the Icons

The icons shown below are used in this document to indicate the severity of the injury or damage that can result if the information indicated by the icon is ignored and the product is used incorrectly as a result.

	WARNING	This icon indicates that death or serious injury can result if the information is ignored.
	CAUTION	This icon indicates that personal injury or material damage can result if the information is ignored.

The icons shown below are used to indicate the nature of the instructions which are to be observed.

	Triangular icons tell you that this information requires attention ("Important").
	Circular icons with a diagonal bar tell you that the action indicated is prohibited ("Prohibited").
	Filled circles with an exclamation mark indicate an action that must be performed ("Required").

! WARNING

Unplug from power socket

If a problem arises, turn the camera off, remove the battery, and disconnect and unplug the AC power adapter. Continued use of the camera when it is emitting smoke, is emitting any unusual odor, or is in any other abnormal state can cause a fire or electric shock. Contact your FUJIFILM dealer.



Do not allow water or foreign objects to enter the camera. If water or foreign objects get inside the camera, turn the camera off, remove the battery, and disconnect and unplug the AC power adapter. Continued use of the camera can cause a fire or electric shock. Contact your FUJIFILM dealer.



Do not use in the bathroom or shower

Do not use the camera in the bathroom or shower. This can cause a fire or electric shock.



Do not disassemble

Never attempt to change or take apart the camera (never open the case). Failure to observe this precaution can cause fire or electric shock.



Do not touch internal parts

Should the case break open as the result of a fall or other accident, do not touch the exposed parts. Failure to observe this precaution could result in electric shock or in injury from touching the damaged parts. Remove the battery immediately, taking care to avoid injury or electric shock, and take the product to the point of purchase for consultation.













Do not change, heat or unduly twist or pull the connection cord and do not place heavy objects on the connection cord. These actions could damage the cord and cause a fire or electric shock. If the cord is damaged, contact your FUJIFILM dealer.















Do not place the camera on an unstable surface. This can cause the camera to fall or tip over and cause injury.











Never attempt to take pictures while in motion. Do not use the camera while walking or driving. This can result in you falling down or being involved in a traffic accident.

 WARNING	
	Do not touch any metal parts of the camera during a thunderstorm. This can cause an electric shock due to induced current from the lightning discharge.
	Do not use the battery except as specified. Load the battery as shown by the indicator.
	Do not heat, charge or take apart the battery. Do not drop or subject the battery to impacts. Do not store the battery with metallic products. Any of these actions can cause the battery to burst or leak and cause fire or injury as a result.
	Use only batteries or AC power adapters specified for use with this camera. Do not use voltages other than the power supply voltage shown. The use of other power sources can cause a fire.
	If the battery leaks and fluid gets in contact with your eyes, skin or clothing, flush the affected area with clean water and seek medical attention or call an emergency number right away.
	Do not use the charger to charge batteries other than those specified here. The supplied charger is for use only with batteries of the type supplied with the camera. Using the charger to charge conventional batteries or other types of rechargeable batteries can cause the battery to leak, overheat or burst.
	Do not use in the presence of flammable objects, explosive gases, or dust.
	When carrying the battery, install it in a digital camera or keep it in the hard case. When storing the battery, keep it in the hard case. When discarding, cover the battery terminals with insulation tape. Contact with other metallic objects or batteries could cause the battery to ignite or burst.
	Keep memory cards out of the reach of small children. Because memory cards are small, they can be swallowed by children. Be sure to store memory cards out of the reach of small children. If a child swallows a memory card, seek medical attention or call an emergency number.

 WARNING	
	Turn the camera off in crowds. The camera emits radio-frequency radiation that may interfere with pacemakers.
	Turn the camera off in the vicinity of automatic doors, public address systems, and other automatically controlled devices. The camera emits radio-frequency radiation that may cause these devices to malfunction.
	Keep the camera at least 22 cm (0.7 ft.) away from people wearing pacemakers. The camera emits radio-frequency radiation that may interfere with pacemakers.

 CAUTION	
	Do not use this camera in locations affected by oil fumes, steam, humidity or dust. This can cause a fire or electric shock.
	Do not leave this camera in places subject to extremely high temperatures. Do not leave the camera in locations such as a sealed vehicle or in direct sunlight. This can cause a fire.
	Keep out of the reach of small children. This product could cause injury in the hands of a child.
	Do not place heavy objects on the camera. This can cause the heavy object to tip over or fall and cause injury.
	Do not move the camera while the AC power adapter is still connected. Do not pull on the connection cord to disconnect the AC power adapter. This can damage the power cord or cables and cause a fire or electric shock.
	Do not cover or wrap the camera or the AC power adapter in a cloth or blanket. This can cause heat to build up and distort the casing or cause a fire.
	When you are cleaning the camera or you do not plan to use the camera for an extended period, remove the battery and disconnect and unplug the AC power adapter. Failure to do so can cause a fire or electric shock.

 CAUTION	
	When charging ends, unplug the charger from the power socket. Leaving the charger plugged into the power socket can cause a fire.
	Using a flash too close to a person's eyes may temporarily affect the eyesight. Take particular care when photographing infants and young children.
	When a memory card is removed, the card could come out of the slot too quickly. Use your finger to hold it and gently release the card. Injury could result to those struck by the ejected card.
	Request regular internal testing and cleaning for your camera. Build-up of dust in your camera can cause a fire or electric shock. Contact your FUJIFILM dealer to request internal cleaning every two years. Please note that this service is not free of charge.
	Danger of explosion if battery is incorrectly replaced. Replace only with batteries of the same type.
	Remove your fingers from the flash window before the flash fires. Failure to observe this precaution could result in burns.
	Keep the flash window clean and do not use the flash if the window is obstructed. Failure to observe these precautions could cause smoke or discoloration.

The Battery and Power Supply

Note: Check the type of battery used in your camera and read the appropriate sections.

The following describes the proper use of batteries and how to prolong their life. Incorrect use can shorten battery life or cause leakage, overheating, fire, or explosion.

Li-ion Batteries

Read this section if your camera uses a rechargeable Li-ion battery.

The battery is not charged at shipment. Charge the battery before use. Keep the battery in its case when not in use.

Notes on the Battery

The battery gradually loses its charge when not in use. Charge the battery one or two days before use.

Battery life can be extended by turning the camera off when not in use.

Battery capacity decreases at low temperatures; a depleted battery may not function at when cold. Keep a fully charged spare battery in a warm place and exchange as necessary, or keep the battery in your pocket or other warm place and insert it in the camera only when shooting. Do not place the battery in direct contact with hand warmers or other heating devices.

Charging the Battery

Charging times will increase at ambient temperatures below +10°C (+50°F) or above +35°C (+95°F). The battery will not charge at temperatures above 40°C (+104°F); at temperatures below 0°C (+32°F), the battery will not charge.

Do not attempt to recharge a fully charged battery. The battery does not however need to be fully discharged before charging.

The battery may be warm to the touch immediately after charging or use. This is normal.

Battery Life

At normal temperatures, the battery can be recharged about 300 times. A noticeable decrease in the length of time the battery will hold a charge indicates that it has reached the end of its service life and should be replaced.

Storage

Performance may be impaired if the battery is left unused for extended periods when fully charged. Run the battery flat before storing it.

If the camera will not be used for an extended period, remove the battery and store it in a dry place with an ambient temperature of from +15°C to +25°C (+59°F to +77°F). Do not store in locations where moisture could be present or where the battery could be exposed to extremes of temperature.

Cautions: Handling the Battery

- Do not transport or store with metal objects such as necklaces or hairpins.
- Do not expose to flame or heat.
- Do not disassemble or modify.
- Use with designated chargers only.
- Dispose of used batteries promptly.
- Do not drop or subject to strong physical shocks.
- Do not expose to water.
- Keep the terminals clean.
- The battery and camera body may become warm to the touch after extended use. This is normal.

AA Alkaline/Rechargeable Ni-MH Batteries

Read this section if your camera uses AA alkaline or rechargeable AA Ni-MH batteries. Information on compatible battery types may be found elsewhere in the camera manual.

Cautions: Handling the Batteries

- Do not expose to water, flame, or heat, or store in warm or humid conditions.
- Do not transport or store with metal objects such as necklaces or hairpins.
- Do not disassemble or modify the batteries or battery casing.
- Do not subject to strong physical shocks.
- Do not use batteries that are leaking, deformed, or discolored.
- Keep out of reach of infants and small children.
- Insert in the correct orientation.
- Do not mix old and new batteries, batteries with different charge levels, or batteries of different types.

- If the camera will not be used for an extended period, remove the batteries. Note that the camera clock will be reset.
- The batteries may be warm to the touch immediately after use. Turn the camera off and allow the batteries to cool before handling.
- Battery capacity tends to decrease at low temperatures. Keep spare batteries in a pocket or other warm place and exchange as necessary. Cold batteries may recover some of their charge when warmed.
- Fingerprints and other stains on the battery terminals can impair battery performance. Thoroughly clean the terminals with a soft, dry cloth before inserting them in the camera.



If the batteries leak, clean the battery compartment thoroughly before inserting new batteries.



If fluid from the battery comes into contact with skin or clothing, flush the affected area with water. **If fluid enters your eyes, immediately flush the affected area with water and seek medical attention. Do not rub your eyes. Failure to observe this precaution could result in permanent visual impairment.**

Ni-MH Batteries

The capacity of Ni-MH batteries may be temporarily reduced when new, after long periods of disuse, or if they are repeatedly recharged before being fully discharged. This is normal and does not indicate a malfunction. Capacity can be increased by repeatedly discharging the batteries using the discharge option in the camera setup menu and recharging them using a battery charger.

CAUTION: Do not use the discharge option with alkaline batteries.

The camera draws a small amount of current even when off. Ni-MH batteries that have been left in the camera for an extended period may be drawn down to the point that they no longer hold a charge. Battery performance may also drop if the batteries are run down in a device such as a flashlight. Use the discharge option in the camera setup menu to discharge Ni-MH batteries. Batteries that no longer hold a charge even after repeatedly being discharged and recharged have reached the end of their service life and must be replaced.

Ni-MH batteries can be recharged in a battery charger (sold separately). Batteries may become warm to the touch after charging. Refer to the instructions provided with the charger for more information. Use the charger with compatible batteries only.

Ni-MH batteries gradually lose their charge when not in use.

■ Disposal

CAUTION: Dispose of used batteries in accord with local regulations.

AC Power Adapters (Available Separately)

This section applies to all camera models. Use only FUJIFILM AC power adapters designated for use with this camera. Other adapters could damage the camera.

- The AC power adapter is for indoor use only.
- Be sure the DC plug is securely connected to the camera.
- Turn the camera off before disconnecting the adapter. Disconnect the adapter by the plug, not the cable.
- Do not use with other devices.
- Do not disassemble.
- Do not expose to high heat and humidity.
- Do not subject to strong physical shocks.
- The adapter may hum or become hot to the touch during use. This is normal.
- If the adapter causes radio interference, reorient or relocate the receiving antenna.

Using the Camera

- Do not aim the camera at extremely bright light sources, such as the sun in a cloudless sky. Failure to observe this precaution could damage the camera image sensor.
- Strong sunlight focused through the viewfinder may damage the panel of electronic viewfinder (EVF). Do not aim the electronic viewfinder at the sun.

Take/Retest Shots

Before taking photographs on important occasions (such as at weddings or before taking the camera on a trip), take a test shot and view the results to ensure that the camera is functioning normally. FUJIFILM Corporation can not accept liability for damages or lost profits incurred as a result of product malfunction.

Notes on Copyright

Unless intended solely for personal use, images recorded using your digital camera system cannot be used in ways that infringe copyright laws without the consent of the owner. Note that some restrictions apply to the photographing of stage performances, entertainments, and exhibits, even when intended purely for personal use. Users are also asked to note that the transfer of memory cards containing images or data protected under copyright laws is only permissible within the restrictions imposed by those copyright laws.

Handling

To ensure that images are recorded correctly, do not subject the camera to impact or physical shocks while images are being recorded.

Liquid Crystal

In the event that the display is damaged, care should be taken to avoid contact with liquid crystal. Take the urgent action indicated should any of the following situations arise:

- **If liquid crystal comes in contact with your skin**, clean the area with a cloth and then wash thoroughly with soap and running water.
- **If liquid crystal enters your eyes**, flush the affected eye with clean water for at least 15 minutes and then seek medical assistance.
- **If liquid crystal is swallowed**, rinse your mouth thoroughly with water. Drink large quantities of water and induce vomiting, then seek medical assistance.

Although the display is manufactured using extremely high-precision technology, it may contain pixels that are always lit or that do not light. This is not a malfunction, and images recorded with the product are unaffected.

Trademark Information

Digital Split Image is a trademark or registered trademark of FUJIFILM Corporation. **xD-Picture Card** and **xD** are trademarks of FUJIFILM Corporation. The typefaces included herein are solely developed by DynaComware Taiwan Inc. Macintosh, QuickTime, and Mac OS are trademarks of Apple Inc. in the U.S.A. and other countries. Windows 8, Windows 7, Windows Vista, and the Windows logo are trademarks of the Microsoft group of companies. Wi-Fi® and Wi-Fi Protected Setup® are registered trademarks of the Wi-Fi Alliance. Adobe and Adobe Reader are either trademarks or registered trademarks of Adobe Systems Incorporated in the U.S.A. and/or other countries. The SDHC and SDXC logos are trademarks of SD-3C, LLC. The HDMI logo is a trademark. YouTube is a trademark of Google Inc. All other trade names mentioned in this manual are the trademarks or registered trademarks of their respective owners.

Electrical Interference

This camera may interfere with hospital or aviation equipment. Consult with hospital or airline staff before using the camera in a hospital or on an aircraft.

Color Television Systems

NTSC (National Television System Committee) is a color television telecasting specification adopted mainly in the U.S.A., Canada, and Japan. PAL (Phase Alternation by Line) is a color television system adopted mainly in European countries and China.

Electrical Interference

Exif Print is a newly revised digital camera file format in which information stored with photographs is used for optimal color reproduction during printing.

NOTICES

To prevent fire or shock hazard, do not expose the unit to rain or moisture.

Please read the "Safety Notes" and make sure you understand them before using the camera.

Perchlorate Material—special handling may apply. See <http://www.dtc.ca.gov/hazardouswaste/perchlorate>.

For Customers in the U.S.A.

Tested To Comply With FCC Standards
FOR HOME OR OFFICE USE



Contains IC: 7736B-0200002

Contains FCC ID: WZZ-0200002

FCC Statement: This device complies with Part 15 of the FCC Rules. Operation is subject to the following two conditions: (1) This device may not cause harmful interference, and (2) this device must accept any interference received, including interference that may cause undesired operation.

CAUTION: This equipment has been tested and found to comply with the limits for a Class B digital device, pursuant to Part 15 of the FCC Rules. These limits are designed to provide reasonable protection against harmful interference in a residential installation. This equipment generates, uses, and can radiate radio frequency energy and, if not installed and used in accordance with the instructions, may cause harmful interference to radio communications. However, there is no guarantee that interference will not occur in a particular installation. If this equipment does cause harmful interference to radio or television reception, which can be determined by turning the equipment off and on, the user is encouraged to try to correct the interference by one or more of the following measures:

- Reorient or relocate the receiving antenna.
- Increase the separation between the equipment and receiver.
- Connect the equipment into an outlet on a circuit different from that to which the receiver is connected.
- Consult the dealer or an experienced radio/TV technician for help.

FCC Caution: Any changes or modifications not expressly approved by the party responsible for compliance could void the user's authority to operate this equipment.

This transmitter must not be co-located or operating in conjunction with any other antenna or transmitter.

Radiation Exposure Statement: This device meets the government's requirements for exposure to radio waves. This device is designed and manufactured not to exceed the emission limits for exposure to radio frequency (RF) energy set by the Federal Communications Commission of the U.S. Government.

The exposure standard for wireless device employs a unit of measurement known as the Specific Absorption Rate, or SAR. The SAR limit set by the FCC is 1.6W/kg. *Tests for SAR are conducted using standard operating positions accepted by the FCC with the device transmitting at its highest certified power level in all tested frequency bands.

Notes on the Grant: To comply with Part 15 of the FCC Rules, this product must be used with a Fujifilm-specified ferrite-core A/V cable, USB cable, and DC supply cord.



A lithium ion battery that is recyclable powers the product you have purchased. Please call 1-800-8-BATTERY for information on how to recycle this battery.

For Customers in Canada

CAN ICES-3 (B)/NMB-3(B)

CAUTION: This Class B digital apparatus complies with Canadian ICES-003.

Industry Canada statement: This device complies with RSS-210 of the Industry Canada Rules. Operation is subject to the following two conditions: (1) This device may not cause harmful interference, and (2) this device must accept any interference received, including interference that may cause undesired operation.

This device and its antenna(s) must not be co-located or operating in conjunction with any other antenna or transmitter, except tested built-in radios. The County Code Selection feature is disabled for products marketed in the US/ Canada.

Radiation Exposure Statement: The product comply with the

Canada portable RF exposure limit set forth for an uncontrolled environment and are safe for intended operation as described in this manual. The further RF exposure reduction can be achieved if the product can be kept as far as possible from the user body or set the device to lower output power if such function is available.

Disposal of Electrical and Electronic Equipment in Private Households

In the European Union, Norway, Iceland and Liechtenstein: This symbol on the product, or in the manual and in the warranty, and/or on its packaging indicates that this product shall not be treated as household waste. Instead it should be taken to an applicable collection point for the recycling of electrical and electronic equipment.



By ensuring this product is disposed of correctly, you will help prevent potential negative consequences to the environment and human health, which could otherwise be caused by inappropriate waste handling of this product.

This symbol on the batteries or accumulators indicates that those batteries shall not be treated as household waste.



If your equipment contains easy removable batteries or accumulators please dispose these separately according to your local requirements.

The recycling of materials will help to conserve natural resources. For more detailed information about recycling this product, please contact your local city office, your household waste disposal service or the shop where you purchased the product.

In Countries Outside the European Union, Norway, Iceland and Liechtenstein: If you wish to discard this product, including the batteries or accumulators, please contact your local authorities and ask for the correct way of disposal.

In Japan: This symbol on the batteries indicates that they are to be disposed of separately.



Li-ion

European Union regulatory notice

This product complies with the following EU Directives:

- Low Voltage Directive 2006/95/EC
- EMC Directive 2004/108/EC
- R & TTE Directive 1999/5/EC

Compliance with these directives implies conformity to applicable harmonized European standards (European Norms) which are listed on the EU Declaration of Conformity issued by FUJIFILM Corporation for this product or product family.

This compliance is indicated by the following conformity marking placed on the product:



This marking is valid for non-Telecom products and EU harmonized Telecom products (e.g. Bluetooth).

Regarding the Declaration of Conformity, visit http://www.fujifilm.com/products/digital_cameras/x/fujifilm_x30/pdf/index/fujifilm_x30_cod.pdf.

IMPORTANT: Read the following notices before using the camera's built-in wireless transmitter.

- Ⓛ This product, which contains encryption function developed in the United States, is controlled by the United States Export Administration Regulations and may not be exported or re-exported to any country to which the United States embargoes goods.
- **Use only as part of a wireless network.** FUJIFILM does not accept liability for damages resulting from unauthorized use. Do not use in applications requiring a high degree of reliability, for example in medical devices or other systems that may directly or indirectly impact human life. When using the device in computer and other systems that demand a greater degree of reliability than wireless networks, be sure to take all necessary precautions to ensure safety and prevent malfunction.
- **Use only in the country in which the device was purchased.** This device conforms to regulations governing wireless network devices in the country in which it was purchased. Observe all location regulations when using the device. FUJIFILM does not accept liability for problems arising from use in other jurisdictions.
- **Wireless data (images) may be intercepted by third parties.** The security of data transmitted over wireless networks is not guaranteed.
- **Do not use the device in locations subject to magnetic fields, static electricity, or radio interference.** Do not use the transmitter in the vicinity of microwave ovens or in other locations subject to magnetic fields, static electricity, or radio interference that may prevent reception of wireless signals. Mutual interference may occur when the transmitter is used in the vicinity of other wireless devices operating in the 2.4 GHz band.
- **The wireless transmitter operates in the 2.4 GHz band using DSSS and OFDM modulation.**

Wireless Network Devices: Cautions

- **This device operates on the same frequency as commercial, educational, and medical devices and wireless transmitters.** It also operates on the same frequency as licensed transmitters and special unlicensed low-voltage transmitters used in RFID tracking systems for assembly lines and in other similar applications.
- **To prevent interference with the above devices, observe the following precautions.** Confirm that the RFID transmitter is not in operation before using this device. Should you observe that the device causes interference in licensed transmitters used for RFID tracking, immediately choose a new operating frequency for this device to prevent additional interference. If you notice that this device causes interference in low-voltage RFID tracing systems, contact a FUJIFILM representative.



This sticker indicates that this device operates in the 2.4 GHz band using DSSS and OFDM modulation and may cause interference at distances of up to 40 m.

FUJIFILM

FUJIFILM Corporation

7-3, AKASAKA 9-CHOME, MINATO-KU, TOKYO 107-0052, JAPAN

http://www.fujifilm.com/products/digital_cameras/index.html