

# FUJIFILM

## DIGITAL CAMERA

# X-H2

### FF210003

Manual (Network and USB Settings)

This manual covers the network and USB settings available when the camera is used alone or with an optional FT-XH file transmitter attached. Be sure that you have read this manual and understood its contents before using the camera. Keep the manual handy for future reference once you have finished.

The latest versions of the product manuals are available at the website below.

*<https://fujifilm-dsc.com/en/manual/>*







## Chapter Index

---

### **Menu List**

iv

### **1 Getting to Know and Using Network/USB Settings**

1

### **2 Network/USB Setting Menus**

65

### **3 Appendix**





81

## Menu List

Camera menu options are listed below.

### The Network/USB Settings Menu

This menu contains network and USB settings available when the camera is used alone or with an optional FT-XH file transmitter attached.

 NETWORK/USB SETTING	
CREATE/EDIT CONNECTION SETTING	66
SELECT CONNECTION SETTING	71
AIRPLANE MODE	72
 Bluetooth/SMARTPHONE SETTING	73
 instax PRINTER CONNECTION SETTING	76
FTP OPTIONAL SETTING	76
USB POWER SUPPLY/COMM SETTING	78
INFORMATION	79
 RESET NETWORK/USB SETTING	79



## Table of Contents

Chapter Index.....	iii
Menu List.....	iv
The Network/USB Settings Menu.....	iv
About This Manual.....	vii
Symbols and Conventions.....	vii
Terminology.....	vii
Network Settings.....	viii
The FT-XH File Transmitter (Available Separately).....	viii

### **1 Getting to Know and Using Network/USB Settings** **1**

Overview.....	2
Supported Features.....	2
Connection Setting Profiles.....	5
Connecting to Smartphones (Bluetooth).....	6
Installing Smartphone Apps.....	6
Connecting to a Smartphone.....	6
Using the Smartphone App.....	8
Connecting to Smartphones (USB).....	11
Copying Pictures to a Smartphone.....	11
Connecting the Camera and Computer.....	14
Using the Camera as a Webcam.....	16
instax SHARE Printers.....	17
Establishing a Connection.....	17
Printing Pictures.....	18
Tethered Photography.....	19
Tethered Photography via USB.....	19
Tethered Photography via Wireless LAN.....	21
Tethered Photography via Wired LAN (Ethernet).....	26

Uploading Pictures via FTP .....	29
Connecting to FTP Servers.....	29
Adjusting Settings for Connection to FTP Servers .....	39
Uploading Pictures to FTP Servers .....	42
RAW Processing .....	45
Saving and Loading Settings .....	46
Remote Movie Recording Using a Web Browser .....	47
Connecting to the Camera from a Web Browser.....	47
Connecting to the Camera from a Computer or Tablet .....	57
The Remote Recording Display.....	58
Recording Movies Remotely .....	62
Viewing Movies .....	62
Saving and Loading Camera Settings.....	63

## **2 Network/USB Setting Menus** **65**

Network/USB Setting Menu .....	66
CREATE/EDIT CONNECTION SETTING.....	66
SELECT CONNECTION SETTING .....	71
AIRPLANE MODE .....	72
Bluetooth/SMARTPHONE SETTING.....	73
instax PRINTER CONNECTION SETTING.....	76
FTP OPTIONAL SETTING.....	76
USB POWER SUPPLY/COMM SETTING .....	78
INFORMATION .....	79
RESET NETWORK/USB SETTING .....	79

## **3 Appendix** **81**

Troubleshooting .....	82
Errors.....	86

## About This Manual

This manual contains instructions for your FUJIFILM X-H2 digital camera's network and USB features. Be sure you have read and understood its contents before proceeding.

### Symbols and Conventions

The following symbols are used in this manual:



Information that should be read to prevent damage to the product.



Additional information that may be helpful when using the product.



Pages on which related information may be found.

Menus and other text in the displays are shown in **bold**. Illustrations are for explanatory purposes only; drawings may be simplified, while photographs are not necessarily taken with the model of camera described in this manual.

### Terminology

The optional SD, SDHC, SDXC, and Type B CFexpress memory cards the camera uses to store pictures are referred to as "memory cards". The electronic viewfinder may be referred to as the "EVF" and the LCD monitor as the "LCD". Smartphones and tablets are referred to as "smartphones".

## Network Settings

- Please note that FUJIFILM is unable assist in troubleshooting network connections. For information on network settings, consult the network administrator.
- The customer is responsible for securing wireless connections. FUJIFILM accepts no liability for damages resulting from faulty settings or unauthorized third-party access to wireless networks.

## The FT-XH File Transmitter (Available Separately)

- When an optional FT-XH file transmitter is attached, you can:
  - take photographs remotely via wired or wireless LAN (tethered photography),\*
  - upload pictures to an FTP server via wired or wireless LAN using the USB tethering feature on a smartphone or tablet, and
  - film movies remotely while using a web browser to control the camera (or multiple cameras, each with its own wireless transmitter attached) from a computer, smartphone, or tablet.

\*The FT-XH file transmitter supports 2x2 MIMO wireless LAN for transmission speeds faster than are available with the camera alone.

- Menu items marked with an  icon are available when a file transmitter is attached.
- A list of the cameras that support file transmitters is available from the website below. Consult the camera manual for information on such topics as attaching file transmitters.

*<https://fujifilm-dsc.com/en/manual/>*



# Getting to Know and Using Network/USB Settings



## Overview

This chapter outlines features that can among other things be used to upload pictures to, or control the camera and take pictures remotely from, a smartphone or computer.

### Supported Features

Some camera features can be accessed when the camera is used alone, while others require you to attach an optional FT-XH file transmitter.

#### Features Available When the Camera Is Used Alone

Feature	Description	
<b>Connecting to the smartphone app</b>	Connect to smartphones via Bluetooth® and upload pictures or control the camera remotely while the smartphone displays the view through the lens.	6
<b>USB card readers</b>	Connect a card reader to a computer or smartphone via USB and copy pictures from memory cards.	11
<b>Web camera</b>	Connect the camera to a computer via USB for use as a webcam.	16
<b>instax printers</b>	Print pictures on connected instax printers.	17
<b>Tethered photography</b>	Take pictures from a computer to which the camera is connected (“tethered”) via wireless LAN or USB.	19
<b>RAW processing</b>	Harness the power of the camera’s image processing engine when processing RAW pictures on a computer.	45
<b>Saving and Loading Settings</b>	Save camera settings to, or load existing from, a computer.	46

These features can be accessed via **SELECT CONNECTION SETTING**.

## Features Available When an Optional FT-XH File Transmitter Is Attached

Feature	Description	
<b>Tethered photography</b>	Take pictures from a computer to which the camera is connected (“tethered”) via high-speed wireless LAN or USB.	19
<b>FTP upload</b>	Upload pictures to an FTP server.	29
<b>Remote movie recording</b>	Control the camera and take pictures remotely using a web browser on a computer or tablet.	47

These features can be accessed by selecting a connection setting profile to which the desired settings and connection type have been saved using **CREATE/EDIT CONNECTION SETTING**.

-  Access to the network/USB features is only available when a battery is inserted in the camera and at least one battery is inserted in the transmitter.
- If the file transmitter battery runs low while the transmitter is in use, upload and remote (“tethered”) photography will continue—albeit at reduced speeds—powered by the camera battery. Charge the file transmitter battery or insert a fully-charged battery.

## The File Transmitter Indicator Lamp

The file transmitter indicator lamp shows the status of its connection to computers, FTP servers, and the like.

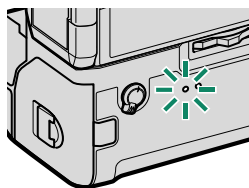





 Only the left lamp lights or flashes.

Indicator lamp	Connection status
<b>Blinks red</b>	No network connection.
<b>Glowes red</b>	No network connection; pictures awaiting upload.
<b>Blinks orange</b>	Connected to network but not to computer tethered photography software or FTP server.
<b>Blinks orange and red</b>	Connected to network but not to computer tethered photography software or FTP server; pictures awaiting upload.
<b>Blinks green</b>	Ready for tethered photography or FTP upload.
<b>Blinks green and red</b>	Ready for tethered photography or FTP upload; pictures awaiting upload.

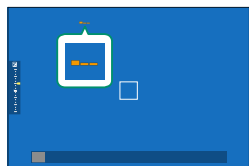
### The EVF/LCD Displays

The status of the connection to computers, FTP servers, and the like is also shown by an icon in the electronic viewfinder or LCD monitor.



Icon	Connection status
	No network connection.
	Connected to network but not to computer tethered photography software or FTP server.
	Ready for tethered photography or FTP upload.

## Connection Setting Profiles

Connection setting profiles contain information on both network settings and the type of connection used. You can connect to computers and smartphones by selecting the associated profile.

### Selecting a Connection Setting Profile

To select a connection setting profile, press **MENU/OK** and choose **SELECT CONNECTION SETTING** in the  (network/USB setting) tab.

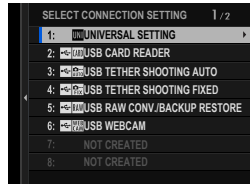

 For tethered photography via wireless LAN, you will first need to create and save a new connection setting profile by following the instructions of a wizard displayed by selecting **CREATE/EDIT CONNECTION SETTING**.

### Saving Connection Setting Profiles

To create a connection setting profile containing information on network/USB settings and the type of connection used, select **CREATE/EDIT CONNECTION SETTING** in the network/USB setting menu.

Choose **CREATE/EDIT CONNECTION SETTING > CREATE USING WIZARD**, select the desired network/USB settings, and save the resulting profile ( 66).

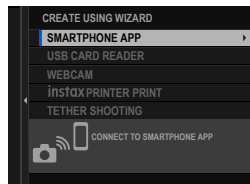

## Connecting to Smartphones (Bluetooth)

Connect the camera with a smartphone via Bluetooth® to copy pictures to the smartphone or control the camera remotely while previewing the view through the lens in the smartphone display.

 The camera automatically switches to a wireless LAN connection when copying pictures to the smartphone.

### Installing Smartphone Apps

Before establishing a connection between the smartphone and camera, you will need to install at least one dedicated smartphone app. Visit the following website and install the desired apps on your phone.

<https://app.fujifilm-dsc.com/>





 The apps available vary with the smartphone operating system.

### Connecting to a Smartphone

Pair the camera with the smartphone and connect via Bluetooth®.

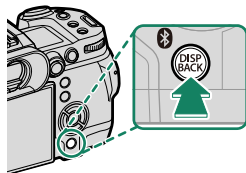
- 1 Press the  (Bluetooth) button when the camera is in shooting mode.



 You can also proceed directly to Step 3 by holding the  button during playback.

**2** Highlight **Bluetooth** and press **MENU/OK**.

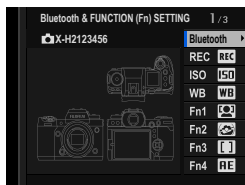

**3** Highlight **PAIRING** and press **MENU/OK**.

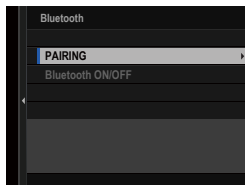



**4** Launch the app on the smartphone and pair the smartphone with the camera.

More information is available at the following website:

<https://app.fujifilm-dsc.com/>

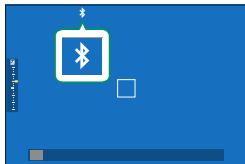
When pairing is complete, the camera and smartphone will automatically connect via Bluetooth. A white Bluetooth icon will appear in the camera display when a connection is established.



-  • Once the devices have been paired, the smartphone will automatically connect to the camera when the app is launched.
- Disabling Bluetooth when the camera is not connected to a smartphone reduces the drain on the battery.

## Using the Smartphone App

Before launching the smartphone app, choose **1: UNIVERSAL SETTING** for **SELECT CONNECTION SETTING**.

 Before proceeding, select **ON** for **Bluetooth/SMARTPHONE SETTING > Bluetooth ON/OFF**.

## Selecting and Downloading Pictures Using the Smartphone App

You can download selected pictures to a smartphone using the smartphone app.

 More information is available from the following website:

<https://app.fujifilm-dsc.com/>

## Uploading Pictures as They Are Taken

Pictures taken with **ON** selected for **Bluetooth/SMARTPHONE SETTING > AUTO IMAGE TRANSFER ORDER** in the network/USB setting menu will automatically be uploaded to the paired device.

-  If **ON** is selected for both **IMAGE TRANSFER WHILE POWER OFF** and **Bluetooth/SMARTPHONE SETTING > Bluetooth ON/OFF** in the network/USB settings menu, upload to the paired device will continue even while the camera is off.
- Selecting **ON** for **Bluetooth/SMARTPHONE SETTING > RESIZE IMAGE FOR SMARTPHONE** in the network/USB setting menu enables compression, reducing file size for upload (📖 75).
- Pictures are uploaded in the format chosen for **Bluetooth/SMARTPHONE SETTING > SELECT FILE TYPE** in the network/USB setting menu.



## Selecting Pictures for Upload in the Playback Menu

Use **TRANSFER IMAGE TO SMARTPHONE > SELECT IMAGE & TRANSFER** to select pictures for upload to a paired smartphone or tablet via Bluetooth®.

### 1 Select **TRANSFER IMAGE TO SMARTPHONE > SELECT IMAGE & TRANSFER**.

 Select **RESET** to remove “upload to smartphone” marking from all pictures before proceeding.

### 2 Mark pictures for upload. Highlight pictures and press **MENU/OK** to mark them for upload.

- To switch to the memory card in the other slot or display only pictures that meet selected criteria, press **DISP/BACK** before marking begins.
- To select all pictures, press the **Q** button.
- Selecting any two pictures with the **AEL** button also selects all pictures between them.

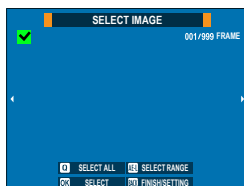

### 3 Press **DISP/BACK** and select **START TRANSFER**.

The selected pictures will be uploaded.

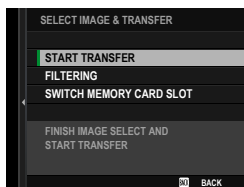

### Filtering Pictures/Choosing a Slot

To switch to the memory card in the other slot or display only pictures that meet selected criteria, press **DISP/BACK** in the picture-selection dialog.

- To display only pictures that meet selected criteria, choose **FILTERING**.
- To switch to the memory card in the other slot, choose **SWITCH MEMORY CARD SLOT**.

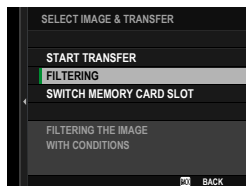

 Switching slots or changing the filter criteria removes any existing upload marking.

-  Image transfer orders can contain a maximum of 999 pictures.
- The following cannot be selected for upload:
  - Protected pictures
  - Movies
  - RAW images
  - "Gift" pictures (pictures taken with other cameras)
- If **ON** is selected for both **IMAGE TRANSFER WHILE POWER OFF** and **Bluetooth/SMARTPHONE SETTING > Bluetooth ON/OFF** in the network/USB settings menu, upload to the paired device will continue even while the camera is off.
- When  **SMARTPHONE TRANSFER ORDER** is selected for  **BUTTON/DIAL SETTING >  ISO BUTTON SETTING**, the picture-selection dialog can be displayed by pressing the **ISO** button.

## Connecting to Smartphones (USB)

Connect to smartphones and computers via USB to upload pictures from the camera.

### Copying Pictures to a Smartphone

Before connecting to the smartphone to upload pictures via USB, select either **AUTO** or **POWER SUPPLY OFF/COMM ON** for **USB POWER SUPPLY/COMM SETTING** in the network/USB setting menu.

### For Customers Using Android Devices

How you will connect the camera depends on the type of USB connector with which your smartphone is equipped.

#### Type-C

Use the supplied USB cable.

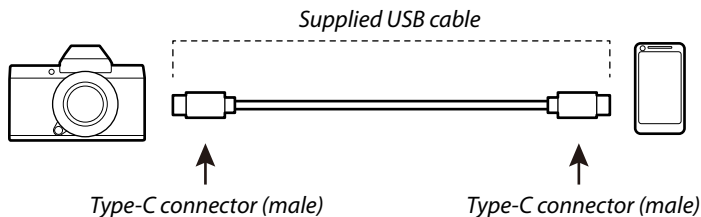

## Micro-B

Use a USB on-the-go (OTG) cable.

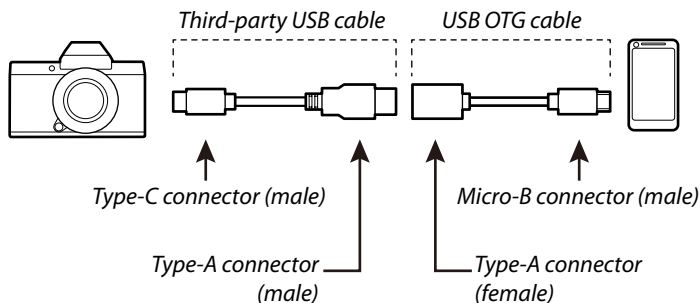

- ! The smartphone must support USB OTG.
- The desired results cannot be achieved with a USB Type-C-to-Micro-B cable. Use an OTG cable.

- 1 Select either **AUTO** or **POWER SUPPLY OFF/COMM ON** for **USB POWER SUPPLY/COMM SETTING** in the network/USB setting menu.
- 2 Choose **2:USB CARD READER** for **SELECT CONNECTION SETTING**.
- 3 Connect the camera and smartphone using a USB cable.
  - 📄 If the smartphone asks for permission for an app other than the "Camera Importer" to access the camera, tap "Cancel" and move on to the next step.
- 4 On your smartphone, tap the notification "Connected to USB PTP".

- From the recommended apps, select “Camera Importer”. The app will automatically start and allow you to import photos and movies to your smartphone.

 If the message “There is no MTP device connected” appears on the app, please try again from step 3.

### For Customers Using iOS

Use a camera adapter. Given that the camera is equipped with a USB Type-C connector, you will need to supply a cable with a USB Type-A connector for connection to the camera adapter.

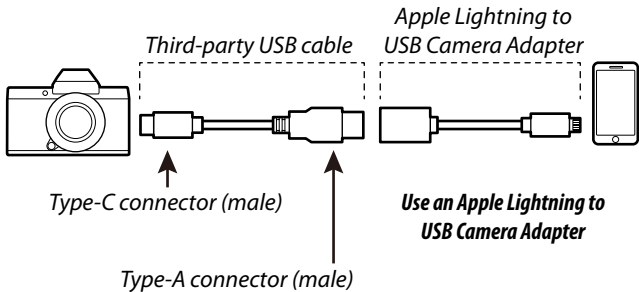

- Select **POWER SUPPLY OFF/COMM ON** for **USB POWER SUPPLY/COMM SETTING** in the network/USB setting menu.
- Choose **2: USB CARD READER** for **SELECT CONNECTION SETTING**.
- Connect the camera and smartphone using a USB cable. Launch the Photos app to import photos and movies to your smartphone.

-  A Type-C to Type-C USB cable is required for connection to iPad and other devices equipped with USB Type-C connectors.
- The desired results cannot be achieved with a USB Type-C-to-Lightning cable. Use a camera adapter.

## Connecting the Camera and Computer

- 1 Select either **AUTO** or **POWER SUPPLY OFF/COMM ON** for **USB POWER SUPPLY/COMM SETTING** in the network/USB setting menu.
- 2 Choose **2:USB CARD READER** for **SELECT CONNECTION SETTING**.
- 3 Turn the camera off.
- 4 Turn the computer on.
- 5 Connect a USB cable.

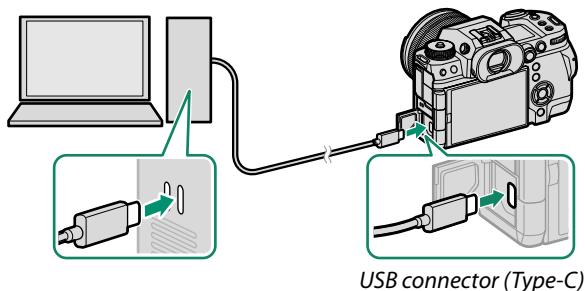

**!** The USB cable must be no more than 1 m (3.3 ft.) long and be suitable for data transfer.

- 6 Turn the camera on.
- 7 Copy pictures to your computer.
  - **Mac OS X/OS X/macOS:** Pictures can be copied to your computer using Image Capture (supplied with your computer) or other software. Use a card reader to copy files over 4 GB in size.
  - **Windows:** Pictures can be copied to your computer using apps supplied with the operating system.



- Turn the camera off before disconnecting the USB cable.
- When connecting USB cables, be sure the connectors are fully inserted in the correct orientation. Connect the camera directly to the computer; do not use a USB hub or keyboard.
- Loss of power during transfer could result in loss of data or damage to the memory card. Insert a fresh or fully-charged battery before connecting the camera.
- If a memory card containing a large number of images is inserted, there may be a delay before the software starts and you may be unable to import or save images. Use a memory card reader to transfer pictures.
- Make sure that the indicator lamp is off or lit green before turning the camera off.
- Do not disconnect the USB cable while transfer is in progress. Failure to observe this precaution could result in loss of data or damage to the memory card.
- Disconnect the camera before inserting or removing memory cards.
- In some cases, it may not be possible to access pictures saved to a network server using the software in the same way as on a stand-alone computer.
- Do not immediately remove the camera from the system or disconnect the USB cable once the message stating that copying is in progress clears from the computer display. If the number of images copied is very large, data transfer may continue after the message has ceased to be displayed.
- The user bears all applicable fees charged by the phone company or Internet service provider when using services that require an Internet connection.

## Using the Camera as a Webcam

The camera can be connected to a computer for use as a webcam.

- 1 Select either **AUTO** or **POWER SUPPLY OFF/COMM ON** for **USB POWER SUPPLY/COMM SETTING** in the network/USB setting menu.
- 2 Choose **6: USB WEBCAM** for **SELECT CONNECTION SETTING**.
- 3 Connect the camera to the computer via USB and then turn the camera on (📖 14).
- 4 Select the camera in the app where it will be used as a webcam.



## instax SHARE Printers

Print pictures from your digital camera to instax SHARE printers.

### Establishing a Connection

Select **instax PRINTER CONNECTION SETTING** in the network/USB setting menu and enter the instax SHARE printer name (SSID) and password.

#### The Printer Name (SSID) and Password

The printer name (SSID) can be found on the bottom of the printer; the default password is "1111". If you have already chosen a different password to print from a smartphone, enter that password instead.

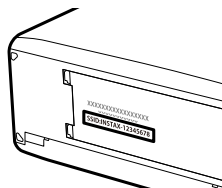

## Printing Pictures

- 1 Choose **1:UNIVERSAL SETTING** for **SELECT CONNECTION SETTING**.
- 2 Turn the printer on.
- 3 Select **PLAY BACK MENU > instax PRINTER PRINT**. The camera will connect to the printer.



- 4 Use the focus stick (focus lever) to display the picture you want to print, then press **MENU/OK**.



- Pictures taken with other cameras cannot be printed.
- The area printed is smaller than the area visible in the LCD monitor.
- The displays may vary depending on the printer connected.

- 5 The picture will be sent to the printer and printing will start.

## Tethered Photography

The camera can be controlled remotely and photographs taken from a computer connected via USB or wireless or wired LAN.

- Tethered Photography via USB (📖 19)
- Tethered Photography via Wireless LAN (📖 21)
- Tethered Photography via Wired LAN (Ethernet) (📖 26)

 You will need an FT-XH file transmitter when performing tethered photography via wired LAN.

### Tethered Photography via USB

Connect the camera to a computer via USB for tethered photography.

- 1 Select either **AUTO** or **POWER SUPPLY OFF/COMM ON** for **USB POWER SUPPLY/COMM SETTING** in the network/USB setting menu.
- 2 Choose either **3:USB TETHER SHOOTING AUTO** or **4:USB TETHER SHOOTING FIXED** for **SELECT CONNECTION SETTING**.

-  • If **3:USB TETHER SHOOTING AUTO** is selected, tethered photography will be enabled automatically when the computer to which the camera is connected is turned on. When the computer is off or not connected, tethered photography will be suspended and pictures will be saved to the camera memory card.
- If the camera is disconnected from the computer while **4:USB TETHER SHOOTING FIXED** is selected, it will continue to function in tethered mode and no pictures will be recorded.

- 3 Connect the camera to the computer via USB and then turn the camera on (📖 14).

#### 4 Take pictures via tethered photography. Use software such as “Adobe Lightroom Classic + FUJIFILM Tether Shooting Plug-in” or “FUJIFILM X Acquire”.



- For more information on tethered photography, visit the website below.

*<https://app.fujifilm-dsc.com/en/tether/>*

- Visit the website below for information on the software used.

*<https://fujifilm-x.com/products/software/>*

## Tethered Photography via Wireless LAN

Connect to a wireless LAN to use a computer on the network for tethered photography.

 Connect an FT-XH file transmitter for wireless LAN connection speeds faster than are available with the camera alone.

- 1 Select **CREATE/EDIT CONNECTION SETTING > CREATE USING WIZARD** in the network/USB setting menu and choose **TETHERED SHOOTING** (📖 66).
- 2 Select **CREATE NEW**.

 Choose **SELECT FROM LIST** to select from a list of existing connection setting profiles.

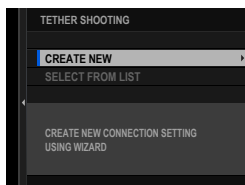

- 3 Press **MENU/OK** when prompted.

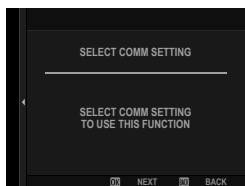

- 4 Select **WIRELESS LAN**.

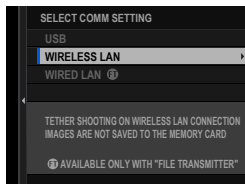

- 5 Select **CREATE NEW** to create a new communication setting profile.

 You can also select or edit existing profiles.

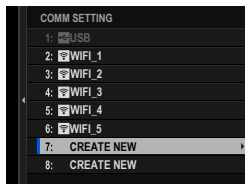

- 6 Adjust wireless LAN settings.
- **ACCESS POINT SETTING:** See “Simple Access Point Connections” (📖 23).
  - **IP ADDRESS SETTING:** See “Connecting Using an IP Address” (📖 24).

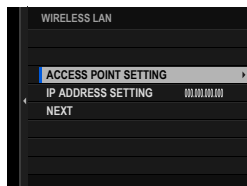

- 7 After adjusting wireless LAN settings, select **NEXT**.

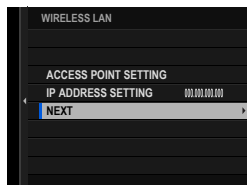

- 8 Name the communication setting profile.

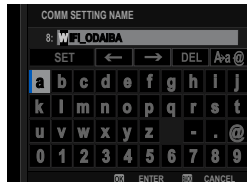

- 9 Save the connection setting profile. Press **MENU/OK**.

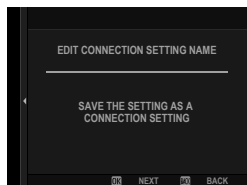

- 10 Select **CREATE NEW**.

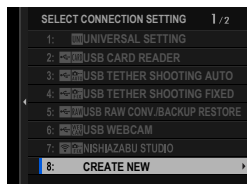

## 11 Name the connection setting profile.



## 12 Choose **SELECT**.

- The connection setting profile can also be selected later using **SELECT CONNECTION SETTING**.

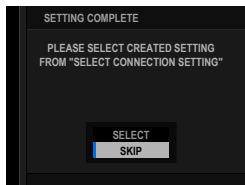

## 13 Take pictures remotely from the computer. Use software that supports tethered photography.

- For more information on tethered photography, visit the website below.  
<https://app.fujifilm-dsc.com/en/tether/>
- Visit the website below for information on the software used.  
<https://fujifilm-x.com/products/software/>

## Simple Access Point Connections

Connect to a computer for tethered photography using the simple setup feature on your wireless LAN router.

### 1 Select **SIMPLE SETUP**.

- To select a wireless LAN router or enter the router SSID manually, choose **MANUAL SETUP**.

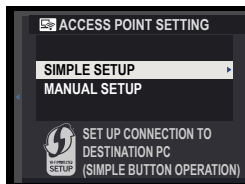

- 2 Follow the on-screen instructions to ready the wireless LAN router.

 You also have the option of connecting using a PIN. Display the camera PIN by pressing the focus stick (focus lever) up and enter it on the wireless LAN router.



- 3 Press **MENU/OK** when setup is complete.

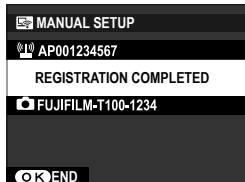

## Connecting Using an IP Address

Connect to a computer for tethered photography using a manually-created network/USB setting profile giving the IP address and other network settings.

- 1 Select **MANUAL**.

 Select **AUTO** to assign the camera an IP address automatically.

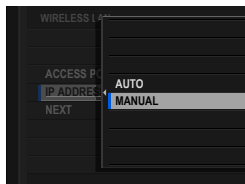

- 2 Enter an IP address.

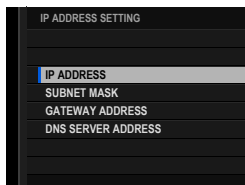



- Select **IP ADDRESS** and enter an IP address.

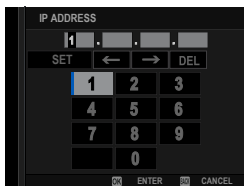

- Select **SUBNET MASK** and enter a subnet mask.

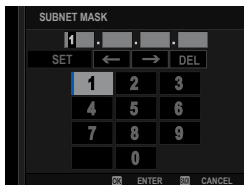

- Select **GATEWAY ADDRESS** and enter a gateway address.

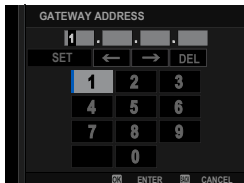

- Select **DNS SERVER ADDRESS** and enter a DNS server address.

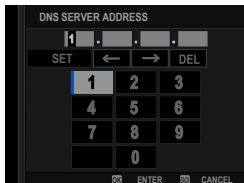

## Tethered Photography via Wired LAN (Ethernet)

Attach an optional FT-XH file transmitter to connect to wired LANs (Ethernet networks) for tethered photography using network computers.

- 1 Connect to the wired LAN by plugging an Ethernet cable into the file transmitter's LAN connector.
- 2 Select **CREATE/EDIT CONNECTION SETTING > CREATE USING WIZARD** in the network/USB setting menu and choose **TETHERED SHOOTING**.
- 3 Select **CREATE NEW**.

 Choose **SELECT FROM LIST** to select from a list of existing connection setting profiles.

- 4 Press **MENU/OK** when prompted.

- 5 Select **WIRED LAN**.

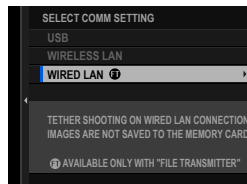
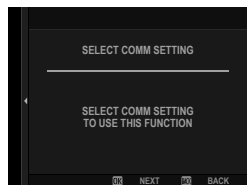
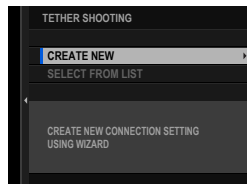

- 6 Select **CREATE NEW** to create a new communication setting profile.

 You can also select or edit existing profiles.

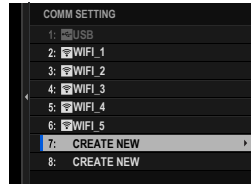

- 7 Adjust **IP ADDRESS SETTING**.

- Select **AUTO** to use an IP address assigned by the network.
- Select **MANUAL** to choose the IP address manually as described in “Connecting Using an IP Address” (📖 24).

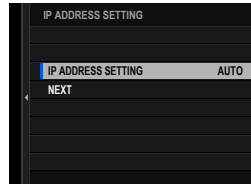

- 8 Select **NEXT** to proceed after adjusting IP address settings.

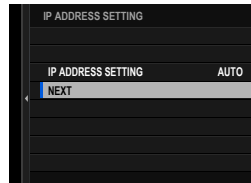

- 9 Name the communication setting profile.



- 10 Save the connection setting profile. Press **MENU/OK**.

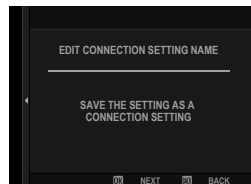

## 11 Select **CREATE NEW**.

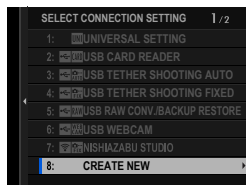

## 12 Name the connection setting profile.

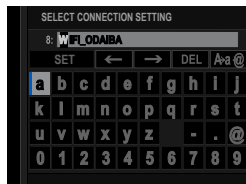

## 13 Choose **SELECT**.



The connection setting profile can also be selected later using **SELECT CONNECTION SETTING**.

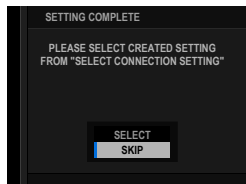

## 14 Take pictures remotely from the computer. Use software that supports tethered photography.



- For more information on tethered photography, visit the website below.

<https://app.fujifilm-dsc.com/en/tether/>

- Visit the website below for information on the software used.

<https://fujifilm-x.com/products/software/>

## Uploading Pictures via FTP

Using an optional FT-XH file transmitter, you can connect the camera to an existing FTP server and upload pictures via FTP.

### Connecting to FTP Servers

- Connecting via Wireless LAN (📖 29)
- Connecting via Wired LAN (Ethernet) (📖 32)
- Connecting via USB Tethering (📖 36)

#### Connecting via Wireless LAN

Connect to an FTP server via wireless LAN.

- 1 Select **CREATE/EDIT CONNECTION SETTING > CREATE USING WIZARD** in the network/USB setting menu and choose **FTP TRANSFER**.
- 2 Select **CREATE NEW**.  
 Choose **SELECT FROM LIST** to select from a list of existing connection setting profiles.
- 3 Press **MENU/OK** when prompted.

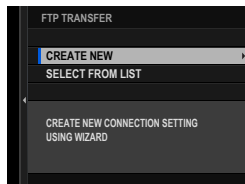

#### 4 Select **WIRELESS LAN**.

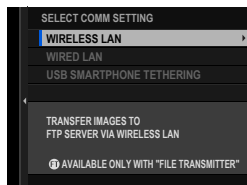

#### 5 Select **CREATE NEW** to create a new communication setting profile.

 You can also select or edit existing profiles.

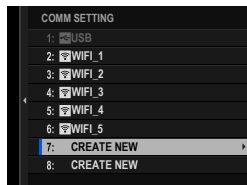

#### 6 Adjust wireless LAN settings.

- **ACCESS POINT SETTING:** See “Simple Access Point Connections” (📖 23).
- **IP ADDRESS SETTING:** See “Connecting Using an IP Address” (📖 24).

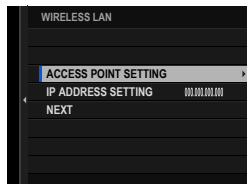

#### 7 After adjusting wireless LAN settings, select **NEXT**.

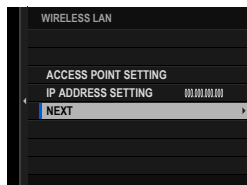

#### 8 Name the communication setting profile.

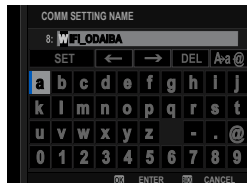

- 9 When prompted, press **MENU/OK** and adjust settings for connection to the FTP server (📖 39).
- 10 Save the connection setting profile when adjustments to settings are complete. Press **MENU/OK**.
- 11 Select **CREATE NEW**.
- 12 Name the connection setting profile.

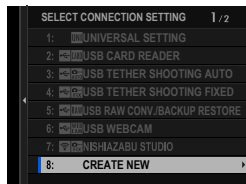
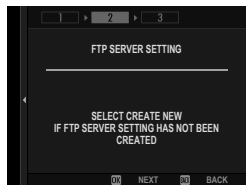

- 13** Select **OK** to test the connection. When a prompt is displayed stating that the test was successful, press **MENU/OK**.

 This step will be skipped if the file transmitter is not currently attached to the camera.

- If the test ends in failure, check the communication setting profile and network settings.

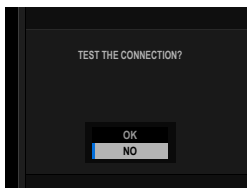

- 14** Choose **SELECT** to finish creating the connection setting profile.

 The connection setting profile can also be selected later using **SELECT CONNECTION SETTING**.

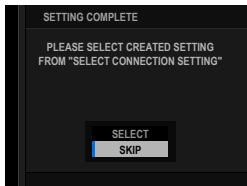

- 15** Upload pictures to the FTP server (📖 42).

## Connecting via Wired LAN (Ethernet)

Connect to an FTP server via wired LAN (Ethernet).

- 1 Connect to the wired LAN by plugging an Ethernet cable into the file transmitter's LAN connector.
- 2 Select **CREATE/EDIT CONNECTION SETTING > CREATE USING WIZARD** in the network/USB setting menu and choose **FTP TRANSFER**.
- 3 Select **CREATE NEW**.

 Choose **SELECT FROM LIST** to select from a list of existing connection setting profiles.

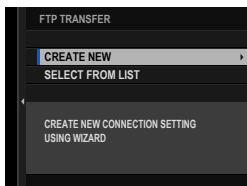



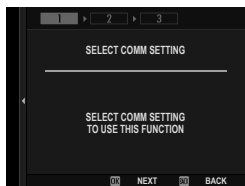

4 Press **MENU/OK** when prompted.

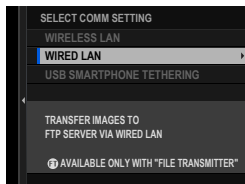

5 Select **WIRED LAN**.



6 Select **CREATE NEW** to create a new communication setting profile.

 You can also select or edit existing profiles.

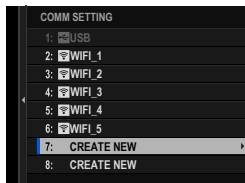

7 Adjust **IP ADDRESS SETTING**.

- Select **AUTO** to use an IP address assigned by the network.
- Select **MANUAL** to choose the IP address manually as described in “Connecting Using an IP Address” (📖 24).

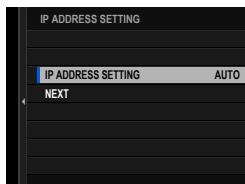

8 Select **NEXT** to proceed after adjusting IP address settings.

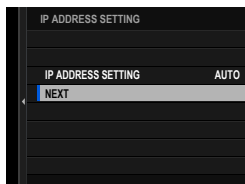

9 Name the communication setting profile.

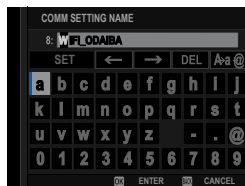

10 When prompted, press **MENU/OK** and adjust settings for connection to the FTP server (39).

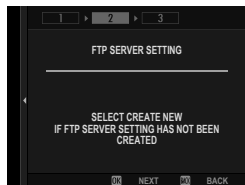

11 Save the connection setting profile when adjustments to settings are complete. Press **MENU/OK**.



12 Select **CREATE NEW**.

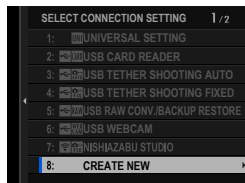

13 Name the connection setting profile.



- 14** Select **OK** to test the connection.  
When a prompt is displayed stating that the test was successful, press **MENU/OK**.



- This step will be skipped if the file transmitter is not currently attached to the camera.
- If the test ends in failure, check the communication setting profile and network settings.



- 15** Choose **SELECT** to finish creating the connection setting profile.



- The connection setting profile can also be selected later using **SELECT CONNECTION SETTING**.

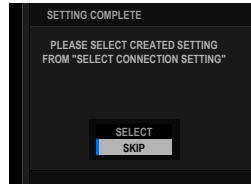

- 16** Upload pictures to the FTP server (📖 42).

## Connecting via USB Tethering

Connect to Internet FTP servers via a network connection on your smartphone.

- 1 Using a USB cable, connect the smartphone to the file transmitter's USB connector.

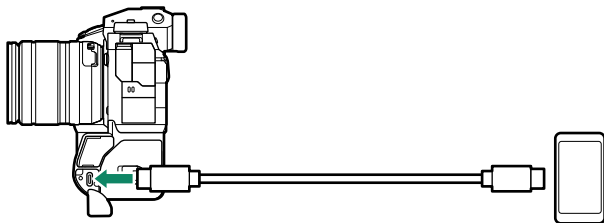

- ! The camera's USB connector cannot be used for this purpose.
- Choose a cable with a USB Type C connector at one end and at the other a connector chosen to match your smartphone (typically USB Type C, USB Micro B, or Lightning).
- Apple Lightning to USB Camera Adapters and USB on-the-go (OTG) cables cannot be used.
- Before connecting the camera, check that the smartphone battery is fully charged, as otherwise the smartphone will attempt to charge itself from the battery in the camera or file transmitter.

- 2 Select **CREATE/EDIT CONNECTION SETTING > CREATE USING WIZARD** in the network/USB setting menu and choose **FTP TRANSFER**.
- 3 Select **CREATE NEW**.

- 📁 Choose **SELECT FROM LIST** to select from a list of existing connection setting profiles.

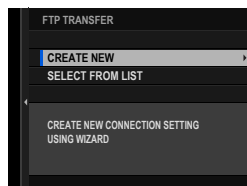

4 Press **MENU/OK** when prompted.

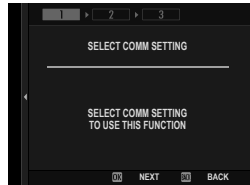

5 Select **USB SMARTPHONE TETHERING**.

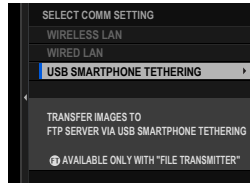

6 When prompted, press **MENU/OK** and adjust settings for connection to the FTP server (📖 39).

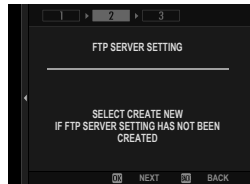

7 Save the connection setting profile when adjustments to settings are complete. Press **MENU/OK**.



8 Select **CREATE NEW**.

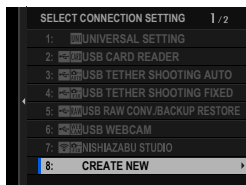

9 Name the connection setting profile.



10 Adjust smartphone settings.  
Configure the smartphone for USB tethering. For more information, see your smartphone's documentation.

11 Select **OK** to test the connection.  
When a prompt is displayed stating that the test was successful, press **MENU/OK**.



12 Choose **SELECT** to finish creating the connection setting profile.

 The connection setting profile can also be selected later using **SELECT CONNECTION SETTING**.

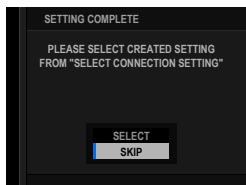

13 Upload pictures to the FTP server (📖 42).

## Adjusting Settings for Connection to FTP Servers

Adjust settings for connection to the destination FTP server.

- 1 Select **CREATE NEW** in the FTP server settings display.



You can also select or edit existing settings.

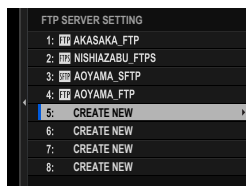

- 2 Choose an FTP server type.

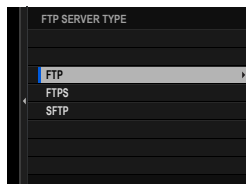

- 3 Enter the FTP server address.



- 4 Enter the FTP server port number.

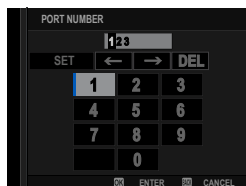

- 5 Choose whether to use a proxy server.

In this case we'll choose **DISABLE**.

 Choose **ENABLE** to enter the address and port number for a proxy server.

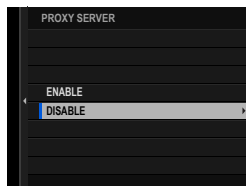

- 6 Choose whether to enable PASV mode.

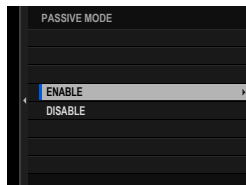

- 7 Select **USER NAME & PASSWORD**.

Enter the user name and password used for login to the FTP server.

 • For connection to servers that do not require a user name and password, select **ANONYMOUS**.

• Selecting **FTPS** for **FTP SERVER TYPE** lets you choose the authentication method. If desired, you can load a self-signed root certificate using **FTP OPTIONAL SETTING > ROOT CERTIFICATE**.

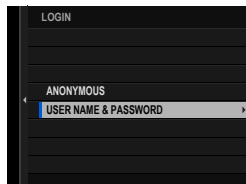

- 8 Choose the destination folder.

- Choose **ROOT FOLDER** to upload pictures to the server's root directory.
- To select a different folder, choose **SPECIFY FOLDER**.

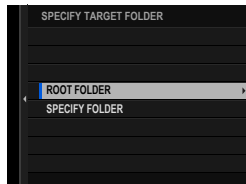



- 9 Choose the procedure used when the destination contains files with the same names as the pictures selected for upload.
- Select **YES** to overwrite the existing files.
  - Select **NO** to rename the uploaded files by adding numbers at the ends of the file names (e.g., "DSCF0001\_(0).JPG").
- 10 Name the FTP server settings.  
The chosen name will appear in the FTP server list.

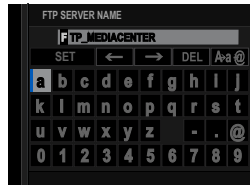
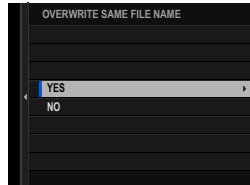

## Uploading Pictures to FTP Servers

Select pictures for upload to an FTP server.

- Selecting Pictures for Upload Using **FTP OPTIONAL SETTING** (📖 42)
- Uploading Pictures as They Are Taken (📖 44)
- Selecting Pictures for Upload During Playback (📖 44)

### Selecting Pictures for Upload Using FTP OPTIONAL SETTING

1 Select **FTP OPTIONAL SETTING** in the network/USB setting menu.

2 Choose **SELECT IMAGE & TRANSFER**.

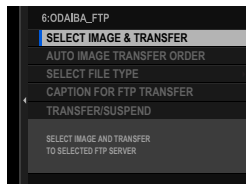

3 Select **TRANSFER**.



If you choose **PRIORITY TRANSFER**, any pictures you then select will be uploaded to the FTP server before pictures selected using **TRANSFER**.

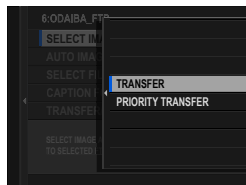

4 Mark pictures for upload. Highlight pictures and press **MENU/OK** to mark them for upload.

- To switch to the memory card in the other slot or display only pictures that meet selected criteria, press **DISP/BACK** before marking begins.
- To select all pictures, press the **Q** button.
- Selecting any two pictures with the **AEL** button also selects all pictures between them.

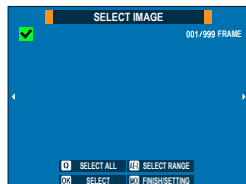

## 5 Press **DISP/BACK** and select **START TRANSFER**.

The selected pictures will be uploaded to the FTP server.

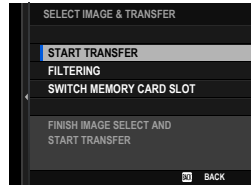

### Filtering Pictures/Choosing a Slot

To switch to the memory card in the other slot or display only pictures that meet selected criteria, press **DISP/BACK** in the picture-selection dialog.

- To display only pictures that meet selected criteria, choose **FILTERING**.
- To switch to the memory card in the other slot, choose **SWITCH MEMORY CARD SLOT**.

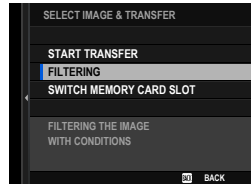

 Switching slots or changing the filter criteria removes any existing upload marking.

-  Image transfer orders can contain a maximum of 9999 pictures.
- If **ON** is selected for **FTP OPTIONAL SETTING > IMAGE TRANSFER WHILE POWER OFF**, upload will continue even while the camera is off.

## Uploading Pictures as They Are Taken

Pictures taken with **ON** selected for **FTP OPTIONAL SETTING > AUTO IMAGE TRANSFER ORDER** in the network/USB setting menu are automatically marked for upload.

## Selecting Pictures for Upload During Playback

If **FTP FTP TRANSFER ORDER** or **FTP FTP PRIORITY TRANSFER ORDER** is selected for **▶ BUTTON/DIAL SETTING > ▶ ISO BUTTON SETTING**, you can mark pictures for upload or change or remove their upload marking using the **ISO** button during playback.

## RAW Processing

Using X RAW STUDIO, you can harness the power of the camera's image processing engine when processing RAW pictures on a computer.

- 1 Select either **AUTO** or **POWER SUPPLY OFF/COMM ON** for **USB POWER SUPPLY/COMM SETTING** in the network/USB setting menu.
- 2 Choose **5:USB RAW CONV./BACKUP RESTORE** for **SELECT CONNECTION SETTING**.
- 3 Connect the camera to the computer via USB and then turn the camera on (📖 14).
- 4 Launch X RAW STUDIO.  
RAW processing can be performed using X RAW STUDIO.



Visit the website below for information on the software used.

<https://fujifilm-x.com/products/software/>

## Saving and Loading Settings

Camera settings can be saved to or loaded from computers using FUJIFILM X Acquire.

- 1 Select either **AUTO** or **POWER SUPPLY OFF/COMM ON** for **USB POWER SUPPLY/COMM SETTING** in the network/USB setting menu.
- 2 Choose **5:USB RAW CONV./BACKUP RESTORE** for **SELECT CONNECTION SETTING**.
- 3 Connect the camera to the computer via USB and then turn the camera on (📖 14).
- 4 Launch FUJIFILM X Acquire.  
Camera settings can be saved or loaded using FUJIFILM X Acquire.



Visit the website below for information on the software used.

<https://fujifilm-x.com/products/software/>

## Remote Movie Recording Using a Web Browser

The optional FT-XH file transmitter supports remote movie recording. You can connect to up to four cameras using a web browser on a computer or tablet and record movies or adjust camera settings.

### Connecting to the Camera from a Web Browser

Attaching an FT-XH file transmitter lets you connect to the camera from a web browser on a computer or tablet and control it remotely.

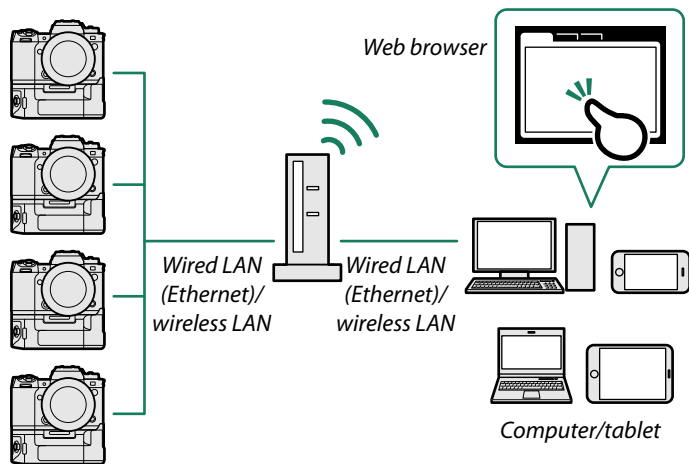

Before recording movies remotely, you will need to create a connection setting profile for use when connecting the camera to a computer or tablet via wireless or wired LAN.

- Connecting via Wireless LAN (📖 48)
- Connecting via Wired LAN (Ethernet) (📖 53)

## Connecting via Wireless LAN

Create a connection setting profile for use when connecting the camera to a computer or tablet via wireless LAN.

- 1 Select **CREATE/EDIT CONNECTION SETTING > CREATE USING WIZARD** in the network/USB setting menu and choose **REMOTE REC FUNCTION**.

- 2 Select **CREATE NEW**.

 Choose **SELECT FROM LIST** to select from a list of existing connection setting profiles.

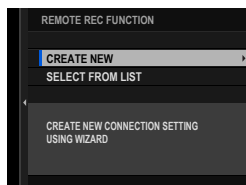

- 3 Press **MENU/OK** when prompted.



- 4 Select **WIRELESS LAN**.

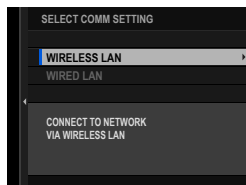



- 5 Select **CREATE NEW** to create a new connection setting profile.

 You can also select or edit existing profiles.

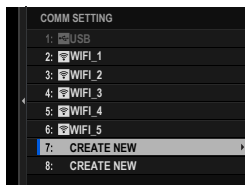

- 6 Adjust wireless LAN settings.
- **ACCESS POINT SETTING:** See “Simple Access Point Connections” (📖 23).
  - **IP ADDRESS SETTING:** See “Connecting Using an IP Address” (📖 24).

 We recommend using (connecting via) a high-speed access point (for example, one that operates in the 5 GHz band).

- 7 After adjusting wireless LAN settings, select **NEXT**.

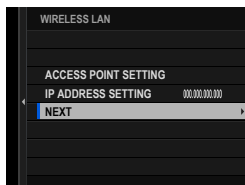
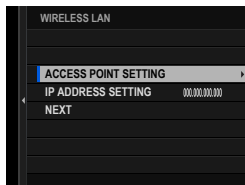

- 8 Name the communication setting profile.



- 9 Create a user name and password for use when connecting to the camera from a computer or tablet.

Press **MENU/OK**.

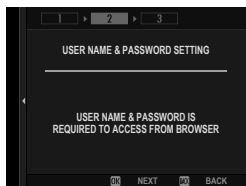

- 10 Enter a user name.



- 11 Enter a password.



- 12 Choose a server type.

 If you choose **HTTPS**, you will need to import a root certificate into the browser on your computer or tablet (see 52).

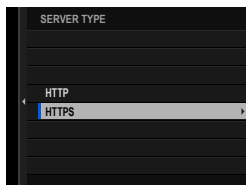

- 13 The camera will display the settings you selected.

Press **MENU/OK**.

 You will need this information when connecting to the camera from a computer or tablet.

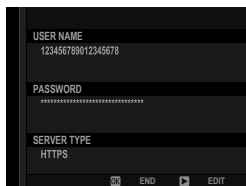

- 14** Save the connection setting profile.  
Press **MENU/OK**.



- 15** Select **CREATE NEW**.

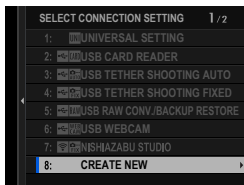

- 16** Name the connection setting profile.



- 17** Choose **SELECT**.

 The connection setting profile can also be selected later using **SELECT CONNECTION SETTING**.

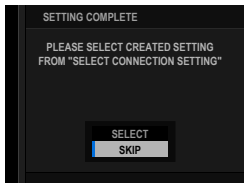

- 18** Connect to the camera from a computer or tablet (📖 57).

### Connecting via HTTPS

If you selected **HTTPS** for **SERVER TYPE**, you will need to import a root certificate into the browser on your computer or tablet. Instructions on downloading and installing a root certificate are available from the following website:

<https://fujifilm-dsc.com/en/manual/rootcer/>



## Connecting via Wired LAN (Ethernet)

Create a connection setting profile for use when connecting the camera to a computer or tablet via wired LAN (Ethernet).

- 1 Select **CREATE/EDIT CONNECTION SETTING > CREATE USING WIZARD** in the network/USB setting menu and choose **REMOTE REC FUNCTION**.

- 2 Select **CREATE NEW**.

 Choose **SELECT FROM LIST** to select from a list of existing connection setting profiles.

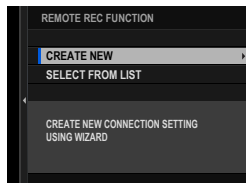

- 3 Press **MENU/OK** when prompted.

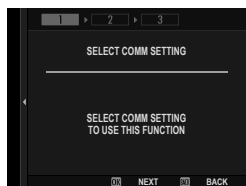

- 4 Select **WIRED LAN**.

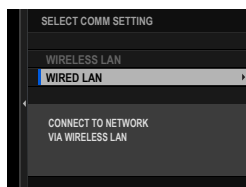

- 5 Select **CREATE NEW** to create a new communication setting profile.

 You can also select or edit existing profiles.

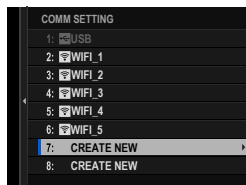

## 6 Adjust IP ADDRESS SETTING.

- Select **AUTO** to use an IP address assigned by the network.
- Select **MANUAL** to choose the IP address manually as described in “Connecting Using an IP Address” (📖 24).



## 7 Select NEXT to proceed after adjusting IP address settings.

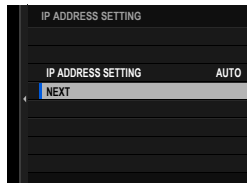

## 8 Name the communication setting profile.



## 9 Create a user name and password for use when connecting to the camera from a computer or tablet. Press MENU/OK.



## 10 Enter a user name.



## 11 Enter a password.



## 12 Choose a server type.

 If you choose **HTTPS**, you will need to import a root certificate into the browser on your computer or tablet (see 52).

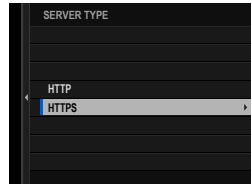

## 13 The camera will display the settings you selected. Press **MENU/OK**.

 You will need this information when connecting to the camera from a computer or tablet.

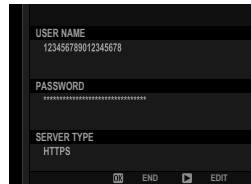

## 14 Save the connection setting profile. Press **MENU/OK**.



## 15 Select **CREATE NEW**.

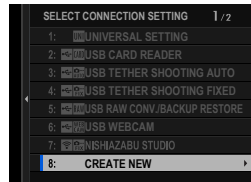

16 Name the connection setting profile.



17 Choose **SELECT**.

 The connection setting profile can also be selected later using **SELECT CONNECTION SETTING**.

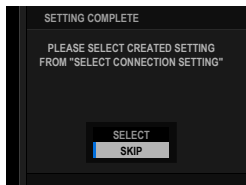

18 Connect to the camera from a computer or tablet (📖 57).



## Connecting to the Camera from a Computer or Tablet

Connect to the camera from a web browser on a computer or tablet.

- 1 Launch the web browser on your computer or tablet and enter the file transmitter's IP address in the address bar.

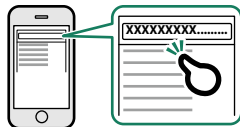

To connect to a camera with an IP address of 192.168.0.11, for example, enter "http://192.168.0.11".

 The camera's IP address can be viewed by selecting **INFORMATION** in the network/USB setting menu.

- 2 Enter the account name and password.  
The remote recording display will appear in the browser.

 We recommend using (connecting via) a high-speed access point (for example, one that operates in the 5 GHz band).

### Connecting to Additional Cameras

- Connections to additional cameras can be made from the remote recording display without ending your current connection. Click or tap a "+" thumbnail in the "Choose camera" area and enter the IP address, account name, and password for the camera you want to add.
- To end a connection after adding a camera, select the "remove connected device" option in the "Remote recording" menu and click or tap the thumbnail for the camera you want to remove.

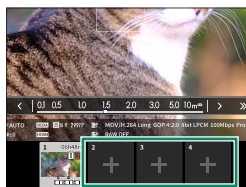

## The Remote Recording Display

The controls available in the remote recording display are detailed below.

 The display layout varies with the size of the computer or tablet screen, among other factors.

### Overview

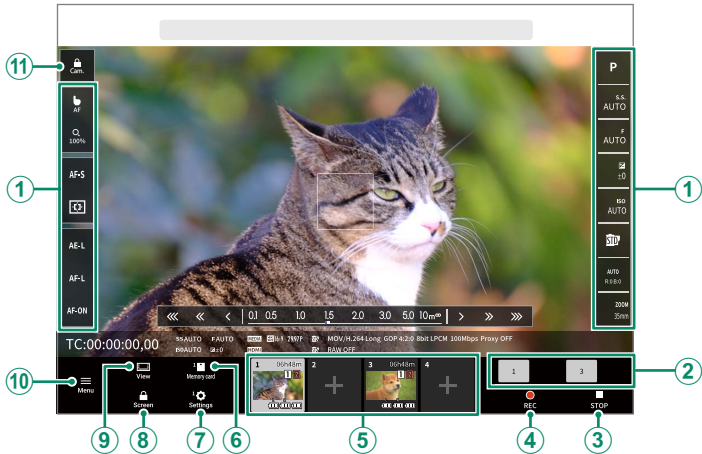

Item	Description
① <b>Camera settings</b>	Adjust settings for the current camera.
② <b>Choose for REC/STOP</b>	Choose the camera or cameras to which the selected action (starting or stopping recording) will apply.
③ <b>STOP button</b>	Stop movie recording.
④ <b>REC button</b>	Start movie recording.
⑤ <b>Choose camera</b>	A list of thumbnails showing the views through the lenses of the connected cameras. Click or tap a thumbnail to select a camera to control.
⑥ <b>Check button for movies in memory card</b>	View the movies on the memory card in the current camera.
⑦ <b>Camera settings (advanced)</b>	Adjust (advanced) settings for the current camera.
⑧ <b>Screen lock button</b>	Enable or disable the controls in the remote recording display.
⑨ <b>Display mode button</b>	Switch displays.
⑩ <b>Remote recording menu</b>	Adjust remote recording settings (📖 61).
⑪ <b>Camera lock button</b>	Lock or unlock the current camera, enabling or disabling its controls.

 If you end the connection to a camera while it is locked, its controls will remain disabled, in which case you will need to turn the camera off.

## Choose Camera

The views through the lenses of the connected cameras are shown in a thumbnail list. Click or tap a thumbnail to select a camera to control.

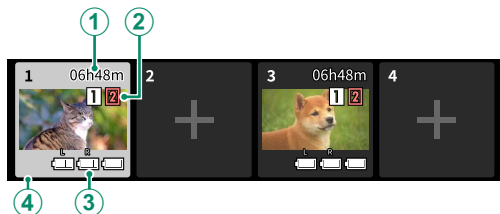

Setting	Description
① <b>Recording time available</b>	The remaining recording time. When the time remaining grows short, the thumbnail will flash and the recording time will be displayed in red.
② <b>Card slot options</b>	Camera storage settings. The icon for the current slot is shown in orange. The display turns red if the camera is unable to record to the current card.
③ <b>Battery level</b>	The battery level. The thumbnail will flash when the battery runs low.
④ <b>Thumbnail frame</b>	A frame appears around the thumbnail for the current camera. Regardless of whether they are currently selected, cameras that are currently recording are highlighted in red or, during high-speed recording, in green.

## **Remote Recording Menu**

---

Adjust remote recording settings.

### **Show histogram**

Hide or view the histogram.

### **Show microphone level**

Hide or view the microphone recording level.

### **Show tool bar**

Hide or view the browser toolbar.

### **Display with Image quality priority/Real-time performance priority**

Choose how you prefer the view through the lens to be displayed, giving priority either to image quality or to ensuring that the picture updates in real time.



- Prioritizing image quality maximizes image quality but may result in display lag.
- Prioritizing real-time display keeps display lag to a minimum regardless of such factors as connection speed.

### **Light mode/Dark mode**

Switch between the light- and dark-mode remote recording displays.

### **Stop the camera connection**

Click or tap a thumbnail in the “Choose camera” area to end the connection to the selected camera.

## Recording Movies Remotely

Start recording on one or more remote cameras or end recording on selected cameras without ending recording on others.

---

- 1** The cameras to which the chosen action (starting or stopping recording) will apply can be selected in the “Choose for REC/STOP” area.  
Select cameras by clicking or tapping the numbers in the “Choose for REC/STOP” area. The numbers for the selected cameras will be highlighted.
- 2** Click or tap the “REC button”.  
The selected cameras will start recording and their thumbnails will be highlighted in color.
- 3** To end recording, select the desired cameras in the “Choose for REC/STOP” area.  
Select cameras by clicking or tapping the numbers in the “Choose for REC/STOP” area. The numbers for the selected cameras will be highlighted.
- 4** Click or tap the “STOP button”.  
The selected cameras will stop recording.

## Viewing Movies

View movies recorded to the camera memory card.

---

- 1** Select a camera in the “Choose camera” area.
- 2** Click or tap the “Check button for movies in memory card”.  
The files on the camera memory card will be displayed.

## Saving and Loading Camera Settings

Save settings for connected cameras to the computer or tablet or load previously-saved settings.

### Saving Camera Settings

Save camera settings to a settings file on the computer or tablet.

1 Select a camera in the “Choose camera” area.

2 Select “Backup” in the “Camera settings (advanced)” menu.



3 Click or tap “Save settings”.  
Settings for the selected camera will be saved to a settings file on the computer or tablet.

### Loading Saved Settings

Load saved settings onto a selected camera.

1 Select a camera in the “Choose camera” area.

2 Select “Restore” in the “Camera settings (advanced)” menu.

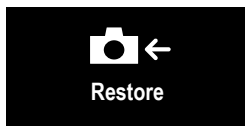

3 Select the desired settings file and click or tap “Load settings”.  
The settings will be copied to the selected camera.

-  The location and procedure for loading files varies with the computer or tablet.
- Only files created with cameras of the same type can be used.

## Copying Settings to Other Cameras

Settings can be copied to multiple cameras simultaneously.

1 Select the source camera in the “Choose camera” area.

2 Select “Copy” in the “Camera settings (advanced)” menu.

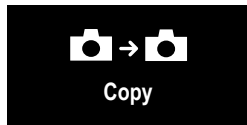

3 Select the destination cameras and click or tap “Copy”.

The settings currently in effect on the source camera will be copied to the destination cameras.

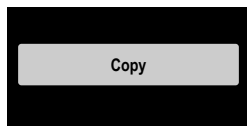

 Only files created with cameras of the same type can be used.



## **Network/USB Setting Menus**

2

## Network/USB Setting Menus

Adjust camera network and USB settings.

To access network/USB settings from the shooting or playback display, press **MENU/OK** and select the  (network/USB setting) tab.

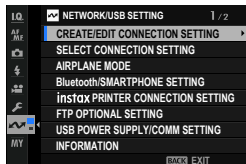

### CREATE/EDIT CONNECTION SETTING

Create or edit connection setting profiles.

#### CREATE USING WIZARD

Choose network/USB and communication settings for a connection setting profile.

- 1 Select **CREATE/EDIT CONNECTION SETTING > CREATE USING WIZARD** in the network/USB setting menu.

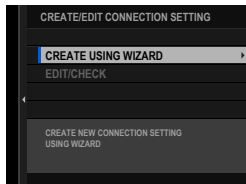

- 2 Choose the desired network/USB settings.

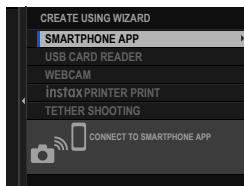

 To use any of the following pre-existing connection setting profiles, choose **SELECT CONNECTION SETTING**.

- 1: UNIVERSAL SETTING
- 2: USB CARD READER
- 3: USB TETHER SHOOTING AUTO
- 4: USB TETHER SHOOTING FIXED
- 5: USB RAW CONV./BACKUP RESTORE
- 6: USB WEBCAM

- 3 Select **CREATE NEW**.

Choosing a tethered photography option displays the options shown. To create a new profile, select **CREATE NEW**.

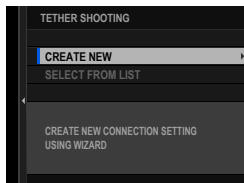

- 4 Adjust network/USB settings.

For more information, refer to the section on the setting in question.

- “Tethered Photography” (📖 19)
- “Uploading Pictures via FTP” (📖 29)
- “Remote Movie Recording Using a Web Browser” (📖 47)

 Saved connection setting profiles are marked by icons indicating the communication setting profile.

## EDIT/CHECK

View or edit existing connection setting profiles.

The instructions that follow are devoted chiefly to choosing communication settings for connection setting profiles used in tethered photography.

- 1 Select **CREATE/EDIT CONNECTION SETTING** > **EDIT/CHECK** in the network/USB setting menu.

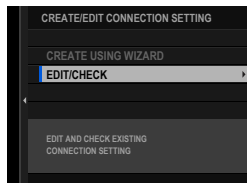

- 2 Choose a connection setting profile.

Options 1 to 6 (**1: UNIVERSAL SETTING** to **6: USB WEBCAM**) are not available.

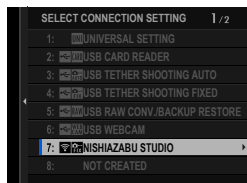

- 3 Select **EDIT/CHECK**.

- To copy an existing connection setting profile, select **COPY**. Choosing an existing profile as the destination overwrites the profile selected in Step 2.
- To test the connection, select **CONNECTION TEST**.
- To delete the selected connection setting profile, select **ERASE**.

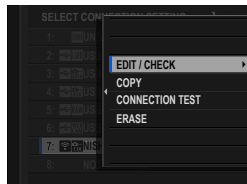

## 4 Select COMM SETTING.

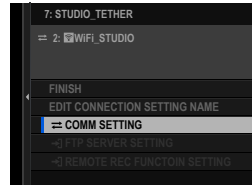

- To rename the connection setting profile, select **EDIT CONNECTION SETTING NAME**.
- If the chosen connection setting profile is for FTP upload, select **FTP SERVER SETTING** to view or edit settings for connection to the FTP server (📖 39).
- If the chosen connection setting profile is for the remote record function, select **REMOTE REC FUNCTOIN SETTING** to view or edit settings for remote movie recording (📖 50, 55).

## 5 Choose an existing communication setting profile.

- To create a new profile, select **CREATE NEW**.

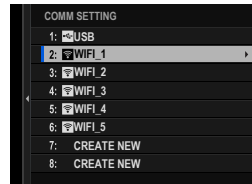

## 6 Select EDIT/CHECK.

- To save the selected communication setting profile to the current connection setting profile, choose **SELECT**.
- To copy an existing communication setting profile, select **COPY**. Choosing an existing profile as the destination overwrites the profile selected in Step 5.
- To delete the selected communication setting profile, select **ERASE**. Deleting a communication setting profile saved to a connection setting profile also deletes the connection setting profile.
- To test the connection, select **CONNECTION TEST**.

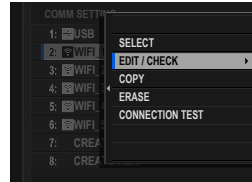

- 7 Review the settings displayed and select **END** to proceed without making changes. To edit settings, press the selector right.

You can now edit the communication setting profile as described in “Simple Access Point Connections” (📖 23) and “Connecting Using an IP Address” (📖 24).

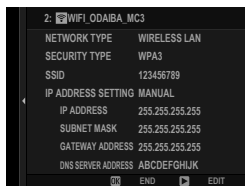

- 8 After editing the communication setting profile, select **NEXT**.

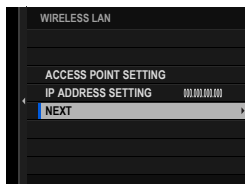

- 9 Name the communication setting profile.



- 10 Choose **SELECT** to save the edited communication setting profile to the current connection setting profile.

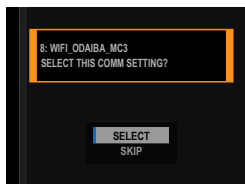

## 11 Select FINISH to end editing.

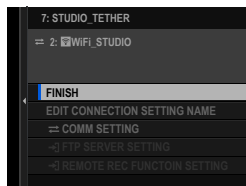

## SELECT CONNECTION SETTING

Select a connection setting profile.

Profile	Description
<b>1: UNIVERSAL SETTING</b>	Connect using the smartphone app or print pictures on instax printers.
<b>2: USB CARD READER</b>	Connect a card reader to a computer or smartphone via USB and copy pictures from memory cards.
<b>3: USB TETHER SHOOTING AUTO</b>	Control the camera and take photographs remotely. <ul style="list-style-type: none"> <li>• Select <b>3: USB TETHER SHOOTING AUTO</b> to automatically enable tethered photography when the computer to which the camera is connected is turned on. Tethered photography is disabled while the computer is off.</li> <li>• If <b>4: USB TETHER SHOOTING FIXED</b> is selected, the camera will continue to function in tethered photography mode even when not connected to a computer.</li> </ul>
<b>4: USB TETHER SHOOTING FIXED</b>	
<b>5: USB RAW CONV./ BACKUP RESTORE</b>	Harness the power of the camera's image processing engine when processing RAW pictures on a computer, or save or load camera settings.
<b>6: USB WEBCAM</b>	Connect the camera to a computer via USB for use as a webcam.
<b>7–16: User-created profiles</b>	Use network/USB settings saved using <b>CREATE/EDIT CONNECTION SETTING</b> .

## Choosing a Connection Setting Profile

Follow the steps below to use pre-existing or user-created connection setting profiles.

- 1 Choose **SELECT CONNECTION SETTING** in the network/USB setting menu.

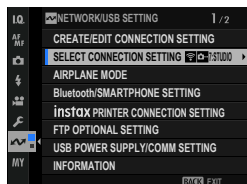

- 2 Choose the desired connection setting profile.

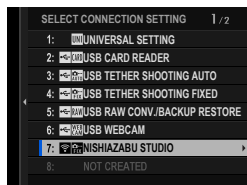

## AIRPLANE MODE

Select **ON** to disable the camera's wireless LAN and Bluetooth features.

### Options

ON

OFF



## Bluetooth/SMARTPHONE SETTING

Adjust Bluetooth-related settings as well as a variety of smartphone-related settings.

 Be sure your smartphone or tablet is running the latest version of the smartphone app.

### PAIRING REGISTRATION

Pair the camera with a smartphone or tablet to which the smartphone app has been installed.

### SELECT PAIRING DESTINATION

Choose a connection from a list of devices with which the camera has been paired using **PAIRING REGISTRATION**. Select **NO CONNECTION** to exit without connecting.

### DELETE PAIRING REG.

Delete existing pairing information for a smartphone or tablet.

 The selected device will be removed from the pairing list.

## Bluetooth ON/OFF

If **ON** is selected, the camera will automatically connect with paired smartphones or tablets running the smartphone app.

Options	
<b>ON</b>	<b>OFF</b>

## AUTO IMAGE TRANSFER ORDER

Select **ON** to upload pictures automatically as they are taken.

Options	
<b>ON</b>	<b>OFF</b>

## SMARTPHONE LOCATION SYNC.

Select **ON** to enable ongoing download of location data from paired smartphones or tablets.

Options	
<b>ON</b>	<b>OFF</b>

 Location data will only be downloaded while the smartphone app is running. Download will be interrupted if pairing is ended. The camera location data icon will be displayed in red if location data have not been updated for over 30 minutes.

## NAME

Choose a name (**NAME**) to identify the camera on the wireless network (the camera is assigned a unique name by default).

## IMAGE TRANSFER WHILE POWER OFF

If **ON** is selected, the camera will continue to upload pictures to paired smartphones or tablets even while off.

Options	
<b>ON</b>	<b>OFF</b>

## RESIZE IMAGE FOR SMARTPHONE

Select **ON** (recommended) to enable compression, reducing file size for upload.

Options	
<b>ON</b>	<b>OFF</b>



- The pictures on the camera memory card are not affected.
- Compression is used only for pictures taken at sizes of L and M.

## WIRELESS COM. FREQUENCY SETTING

Choose the band for wireless LAN connections.

Options	
<b>2.4GHz (IEEE802.11 b/g/n)</b>	<b>5GHz (IEEE802.11 a/n/ac)</b>



- Some countries and regions prohibit outdoor use of certain channels in the 5 GHz band. Check whether use of the 5.2 GHz (W52) band is permitted before selecting the 5 GHz option.
- The options available vary with the country or region of sale.

## SELECT FILE TYPE

Choose the format or formats used for upload. Pictures can be uploaded in **JPEG** format and/or **HEIF**.

## instax PRINTER CONNECTION SETTING

Adjust settings for connection to optional Fujifilm instax SHARE printers.

### The Printer Name (SSID) and Password

The printer name (SSID) can be found on the bottom of the printer; the default password is "1111". If you have already chosen a different password to print from a smartphone, enter that password instead.

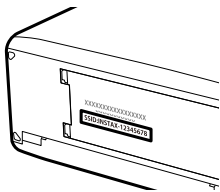

## FTP OPTIONAL SETTING

Adjust settings for FTP upload.

### SELECT IMAGE & TRANSFER

Mark picture for upload (📖 42).

### AUTO IMAGE TRANSFER ORDER

Select **ON** to automatically mark pictures for upload as they are taken.

Options	
ON	OFF

### SELECT FILE TYPE

Choose the types of files uploaded to the FTP server. You can select or deselect each file type individually.

Options					
JPEG	RAW	HEIF	TIFF	MOV	MP4

## CAPTION FOR FTP TRANSFER

Add captions to photos and movies during upload.

Option	Description
<b>DEFAULT CAPTION</b>	Add the caption selected for <b>SAVE DATA SETTING &gt; DEFAULT CAPTION</b> .
<b>CREATED CAPTION</b>	Create new captions or select existing captions.
<b>NO CAPTION</b>	Do not add captions to pictures during upload.

## TRANSFER/SUSPEND

Pause or resume FTP upload.

Options	
<b>TRANSFER</b>	<b>SUSPEND</b>

## IMAGE TRANSFER WHILE POWER OFF

If **ON** is selected, upload of pictures to the FTP server will continue while the camera is off.

Options	
<b>ON</b>	<b>OFF</b>

## FTP POWER SAVING

If **ON** is selected, the file transmitter will turn off to save power when the upload of all pictures currently marked for transfer is complete. Marking additional pictures for upload turns the transmitter on again.

Options	
<b>ON</b>	<b>OFF</b>

## ROOT CERTIFICATE

Copy a unique root certificate to the file transmitter for use when FTPS is selected for **FTP SERVER TYPE** (📖 39).

Option	Description
<b>LOAD FROM MEMORY CARD</b>	Copy the root certificate from the camera memory card.
<b>DELETE</b>	Delete the current root certificate from the file transmitter.

⚠ This item is for use only when a file transmitter is connected.

## RESET FTP TRANSFER ORDER

Remove upload marking from all pictures selected for upload to the FTP server in the current connection setting profile.

## USB POWER SUPPLY/COMM SETTING

Choose whether USB connections to computers, smartphones, or other devices are used for power delivery or data transfer.

Option	Description
<b>AUTO</b>	The camera switches between power delivery and data transfer automatically.
<b>POWER SUPPLY ON/COMM OFF</b>	The camera draws power from the connected device, reducing the drain on the battery. Data transfer is disabled.
<b>POWER SUPPLY OFF/COMM ON</b>	The camera can exchange data with, but not draw power from, the connected device.

⚠ The camera cannot draw power from Lightning connections or from devices that do not supply power. Select **POWER SUPPLY OFF/COMM ON** before connecting the camera to such devices. The connection may not be available for data transfer or the like when **POWER SUPPLY ON/COMM OFF** is selected.

🔌 Regardless of the option selected, the battery will charge while the camera is off.

**INFORMATION**

View network-related settings.

Option	Description
<b>HARDWARE INFO</b>	View the camera's MAC, Bluetooth, and wireless network IP addresses. If a file transmitter is currently connected, its MAC address and wireless and wired LAN IP addresses will also be displayed.
<b>FTP TRANSFER ORDER STATUS</b>	View upload progress and the destination for pictures uploaded to the FTP server in the current connection setting profile. This item is available when the camera is connected to an optional FT-XH file transmitter.
<b>ERROR DESCRIPTION</b>	View the content of errors when a  icon is displayed or the camera is unable to connect to the file transmitter (86).

**RESET NETWORK/USB SETTING**

Reset network/USB settings to default values.





# Appendix 3

## Troubleshooting

Consult the table below should you encounter problems using your camera. If you don't find the solution here, contact your local Fujifilm distributor.

### Wired Connections

Problem	Solution
The computer does not recognize the camera.	Be sure the camera and computer are correctly connected (📖 14).
FUJIFILM X RAW STUDIO or FUJIFILM X Acquire fails to correctly detect the camera.	Check camera settings. If the camera is connected via USB, be sure <b>5: USB RAW CONV./BACKUP RESTORE</b> is chosen for <b>SELECT CONNECTION SETTING</b> . (📖 45, 46).
Cannot connect to iPhones or iPads.	<b>POWER SUPPLY ON/COMM OFF</b> is selected for <b>USB POWER SUPPLY/COMM SETTING</b> . Select <b>POWER SUPPLY OFF/COMM ON</b> when the camera is connected via a Lightning connection to a device that do not supply power (📖 13).
Cannot connect to smartphone.	<b>Confirm that the camera is correctly connected:</b> The procedure for connecting the camera varies with the type of connector with which the smartphone is equipped (📖 11).

## Wireless Transfer

For additional information on troubleshooting wireless connections, visit:

<https://digitalcamera-support-en.fujifilm.com/>

Problem	Solution
<p>Cannot connect to smartphone. The camera is slow to connect or upload pictures to the smartphone. Upload fails or is interrupted.</p>	<ul style="list-style-type: none"> <li>• <b>The smartphone is too far away:</b> Move the devices closer (📖 6).</li> <li>• <b>Nearby devices are causing radio interference:</b> Move the camera and smartphone away from microwave ovens or cordless phones (📖 6).</li> </ul>
<p>Cannot upload images.</p>	<ul style="list-style-type: none"> <li>• <b>The smartphone is connected to another device:</b> The smartphone and camera can connect to only one device at a time. End the connection and try again (📖 6).</li> <li>• <b>There are several smartphones in the vicinity:</b> Try connecting again. The presence of multiple smartphones can make connection difficult (📖 6).</li> <li>• <b>The image was created on another device:</b> The camera may not be able to upload images created on other devices.</li> <li>• <b>The image is a movie:</b> Uploading movies takes some time. In addition, smartphones may not accept upload of movies in formats they do not support.</li> </ul>

Problem	Solution
Smartphone will not display pictures.	Select <b>ON</b> for <b>Bluetooth/SMARTPHONE SETTING &gt; RESIZE IMAGE FOR SMARTPHONE</b> . Selecting <b>OFF</b> increases upload times for larger images; in addition, some phones may not display images over a certain size (📖 75).

## Remote Movie Recording

Problem	Solution
The remote recording display does not appear in the browser.	<ul style="list-style-type: none"> <li>• <b>The IP address is incorrect:</b> Enter the correct IP address. Note that the IP address may change unexpectedly if automatic IP address assignment is enabled (📖 47).</li> <li>• <b>The access point for the computer or tablet is not configured correctly:</b> Be sure the access point for the computer or tablet is configured correctly (📖 47).</li> <li>• <b>The camera is not on the same network as the computer or tablet:</b> Be sure the camera is connected to the same local-area network (LAN) as the computer or tablet (📖 47).</li> <li>• <b>The camera clock is not set to the correct date:</b> Set the camera clock to the correct date (day, month, and year).</li> <li>• Delete the browser history and/or cache.</li> </ul>

Problem	Solution
<p>The browser is slow to update the view through the camera lens.</p>	<ul style="list-style-type: none"> <li>• <b>The connection is not high speed:</b> Be sure both the camera and the computer or tablet are connected to the network via Ethernet or high-speed (e.g., 5 GHz) wireless.</li> <li>• <b>The browser is configured to prioritize image quality over performance:</b> Select real-time performance for “Display with Image quality priority/Real-time performance priority” in the browser remote recording menu (📖 61).</li> </ul>
<p>The browser does not display the same menus or other text as the camera.</p>	<p><b>Automatic translation is enabled in the browser:</b> Disable automatic translation.</p>
<p>The computer or tablet cannot connect to the camera via HTTPS.</p>	<ul style="list-style-type: none"> <li>• <b>The camera root certificate has not been installed on the computer or tablet:</b> Install the camera root certificate on the computer or tablet (📖 52).</li> <li>• <b>The camera IP address has changed:</b> The camera root certificate must be reinstalled on the computer or tablet each time the camera’s IP address changes.</li> </ul>
<p>The computer or tablet cannot connect to multiple cameras via HTTPS.</p>	<p><b>Root certificates for some cameras have not been installed on the computer or tablet:</b> Install root certificates for all cameras (📖 52).</p>

## Errors

If a  icon appears in the display or if the camera and file transmitter cannot connect, select **INFORMATION > ERROR DESCRIPTION** in the network/USB setting menu to view the error and then take the appropriate action.

Error	Solution
FILE TRANSMITTER IS NOT ATTACHED	<b>The file transmitter is not correctly attached:</b> Re-attach the file transmitter.
PLEASE INSERT BATTERIES INTO CAMERA AND FILE TRANSMITTER TO USE FILE TRANSMITTER	<ul style="list-style-type: none"><li>• <b>There is no battery in the camera:</b> Insert the battery in the camera.</li><li>• <b>The camera battery is exhausted:</b> Insert a fully-charged battery.</li><li>• <b>There is no battery in the file transmitter:</b> Insert the battery in the file transmitter.</li><li>• <b>The file transmitter battery is exhausted:</b> Insert a fully-charged battery.</li><li>• <b>The battery tray is not securely closed:</b> Securely close the battery tray.</li></ul>
STARTING UP FILE TRANSMITTER	Try again later.
FILE TRANSMITTER IS NOT CONNECTED TO NETWORK VIA ETHERNET CABLE	<b>The wired LAN (Ethernet) cable is not connected:</b> Connect the wired LAN (Ethernet) cable.
FILE TRANSMITTER IS NOT CONNECTED TO NETWORK VIA USB SMARTPHONE TETHERING	<ul style="list-style-type: none"><li>• <b>The smartphone is not connected to the file transmitter via USB:</b> Connect the smartphone to the file transmitter's USB connector.</li><li>• <b>Smartphone USB tethering settings require adjustment:</b> Adjust USB tethering settings on the smartphone.</li></ul>

Error	Solution
<p><b>FILE TRANSMITTER IS NOT CONNECTED TO NETWORK VIA WIRELESS LAN</b></p>	<ul style="list-style-type: none"> <li>• <b>No connection to access point:</b> Confirm that the access point is on, verify its settings and IP address, and check that there are no obstructions blocking its signal. If necessary, move the camera closer to the access point.</li> <li>• <b>Camera settings have not been correctly adjusted for connection to the access point:</b> Check that the password, encryption type, and SSID match those chosen for the access point.</li> </ul>
<p><b>IP ADDRESS CANNOT BE ASSIGNED BY DHCP SERVER OR THERE IS AN ISSUE WITH IP ADDRESS SETTING PLEASE CHECK SETTINGS</b></p>	<ul style="list-style-type: none"> <li>• <b>No DHCP server:</b> If there is no DHCP server on the network, enter the IP address and other information manually.</li> <li>• <b>The DHCP server is down:</b> Contact the network administrator.</li> </ul>
<p><b>CANNOT REACH FTP SERVER OR COMMUNICATE WITH FTP SERVER PLEASE CHECK SETTINGS</b></p>	<ul style="list-style-type: none"> <li>• <b>Duplicate IP address:</b> Change the camera IP address to ensure that it does not duplicate the address of any other device on the network.</li> <li>• <b>Invalid IP address:</b> If the network includes a DHCP server, select auto address allocation. If IP addresses are assigned manually, check that the IP address is correct.</li> <li>• <b>The DNS server address is incorrect:</b> If you configured the DNS address manually, be sure the information you entered is correct.</li> <li>• <b>FTP server settings are incorrect:</b> Check that the server type, server address, port number, and proxy settings are correct.</li> <li>• <b>The FTP server is down:</b> Contact the network administrator.</li> </ul>

Error	Solution
LOGIN TO FTP SERVER HAS FAILED	<b>Incorrect user name or password:</b> Check that you have supplied the correct user name and password.
CANNOT TRANSFER OR SAVE FILES TO FTP SERVER	<ul style="list-style-type: none"><li>• <b>FTP server permissions are configured incorrectly:</b> Check that you have write access to the FTP server.</li><li>• <b>The FTP server is full:</b> Check the amount of free storage space remaining on the FTP server.</li></ul>
CA ROOT CERTIFICATE IS INVALID	<b>The root certificate has expired:</b> Load an updated CA root certificate.
UNEXPECTED ERROR HAS OCCURRED	<ul style="list-style-type: none"><li>• Turn the camera off and then on again.</li><li>• Contact the network administrator.</li></ul>









# FUJIFILM

---

**FUJIFILM Corporation**

7-3, AKASAKA 9-CHOME, MINATO-KU, TOKYO 107-0052, JAPAN

<https://fujifilm-x.com>

