

**FUJIFILM**

DIGITAL CAMERA

**X-A5**

Owner's Manual

## Introduction

Thank you for your purchase of this product. Be sure that you have read this manual and understood its contents before using the camera. Keep the manual where it will be read by all who use the product.

### For the Latest Information

The latest versions of the manuals are available from:

*<http://fujifilm-dsc.com/en/manual/>*



The site can be accessed not only from your computer but also from smartphones and tablets.



For information on firmware updates, visit:

*[http://www.fujifilm.com/support/digital\\_cameras/software/](http://www.fujifilm.com/support/digital_cameras/software/)*





## Chapter Index

---

<b>Menu List</b>	iv
<b>1 Before You Begin</b>	1
<b>2 First Steps</b>	19
<b>3 Basic Photography and Playback</b>	35
<b>4 Movie Recording and Playback</b>	41
<b>5 Taking Photographs</b>	47
<b>6 The Shooting Menus</b>	97
<b>7 Playback and the Playback Menu</b>	123
<b>8 The Setup Menus</b>	141
<b>9 Shortcuts</b>	157
<b>10 Peripherals and Optional Accessories</b>	163
<b>11 Connections</b>	169
<b>12 Technical Notes</b>	181



























# Menu List

















Camera menu options are listed below.

## Shooting Menus

Adjust settings when shooting photos or movies.

 See page 97 for details.



















SHOOTING MENU		
	 SCENE POSITION	98
	 ADVANCED FILTER	98
	 AF/MF SETTING	98
	 RELEASE TYPE	101
	 ISO	102
	 IMAGE SIZE	103
	 IMAGE QUALITY	104
	 DYNAMIC RANGE	105
	 FILM SIMULATION	106
	 FILM SIMULATION BKT	107
	 SELF-TIMER	107
	 INTERVAL TIMER SHOOTING	108
	 TIME-LAPSE MOVIE MODE	109
	 WHITE BALANCE	110
	 COLOR	110
	 SHARPNESS	110
	 HIGHLIGHT TONE	110
	 SHADOW TONE	111
	 NOISE REDUCTION	111
	 LONG EXPOSURE NR	111
	 AE BKT SETTING	112
	 TOUCH SCREEN MODE	112

SHOOTING MENU		
	 TOUCH ZOOM	112
	 MOUNT ADAPTOR SETTING	113
	 SHOOT WITHOUT LENS	115
	 MF ASSIST	115
	 PHOTOMETRY	115
	 INTERLOCK SPOT AE & FOCUS AREA	116
	 FLASH SET-UP	116
		 MOVIE SET-UP
 IS MODE		120
 DIGITAL IMAGE STABILIZER		120
 WIRELESS COMMUNICATION		121
 SHUTTER TYPE		121
 ELECTRONIC ZOOM SETTING		122

## Playback Menu

Adjust playback settings.





















 See page 129 for details.

PLAYBACK MENU			PLAYBACK MENU		
	IMAGE TRANSFER ORDER	129		IMAGE ROTATE	135
	WIRELESS COMMUNICATION	130		RED EYE REMOVAL	136
	RAW CONVERSION	130		SLIDE SHOW	136
 	ERASE	132		PHOTOBOOK ASSIST	137
	CROP	134		PC AUTO SAVE	138
	RESIZE	134		PRINT ORDER (DPOF)	139
	PROTECT	135		instax PRINTER PRINT	140
			 	DISP ASPECT	140

## Setup Menu

Adjust basic camera settings.

 See page 141 for details.

SET-UP			SET-UP		
	DATE/TIME	142		BUTTON SETTING	148
	TIME DIFFERENCE	142		FOCUS RING	148
	言語/LANG.	142		TOUCH SCREEN SETTING	148
 	RESET	143		POWER MANAGEMENT	149
	SOUND & FLASH	143		SENSOR CLEANING	149
	SOUND SET-UP	144		SAVE DATA SET-UP	150
	SCREEN SET-UP	145		COLOR SPACE	151
			 	CONNECTION SETTING	152
			 	FORMAT	155



# Table of Contents

Introduction.....	ii
For the Latest Information.....	ii
Menu List.....	iv
Shooting Menus.....	iv
Playback Menus.....	v
Setup Menus.....	v
Supplied Accessories.....	xiv
About This Manual.....	xv
Symbols and Conventions.....	xv
Terminology.....	xv

## 1 Before You Begin 1

Parts of the Camera.....	2
The Mode Dial.....	4
The Selector.....	5
The Serial Number Plate.....	5
The Command Dials.....	6
The Indicator Lamp.....	7
The LCD Monitor.....	7
Camera Displays.....	8
The LCD Monitor.....	8
Adjusting Display Brightness.....	10
The DISP/BACK Button.....	10
Customizing the Standard Display.....	11
Using the Menus.....	13
Touch Screen Mode.....	14
Shooting Touch Controls.....	14
Playback Touch Controls.....	18

## 2 First Steps 19

Attaching the Shoulder Strap.....	20
Attaching a Lens.....	21
Inserting the Battery and a Memory Card.....	22
Compatible Memory Cards.....	25
Charging the Battery.....	26



























Turning the Camera On and Off .....	29
Checking the Battery Level.....	30
Basic Setup .....	31
Choosing a Different Language.....	33
Changing the Time and Date.....	33
<b>3 Basic Photography and Playback</b> .....	<b>35</b>
Taking Photographs.....	36
▶ Viewing Pictures.....	38
🗑 Deleting Pictures.....	39
<b>4 Movie Recording and Playback</b> .....	<b>41</b>
🎥 Recording Movies.....	42
Adjusting Movie Settings.....	44
▶ Viewing Movies.....	45
<b>5 Taking Photographs</b> .....	<b>47</b>
Choosing a Shooting Mode .....	48
📷+ ADVANCED SR AUTO .....	48
Program AE (P).....	49
Shutter-Priority AE (S).....	50
Aperture-Priority AE (A).....	52
Manual Exposure (M).....	53
📺 PANORAMA.....	56
SP SCENE POSITION / 🌊 / ▲ / 🏃 / 🌙 .....	59
Adv. ADVANCED FILTER .....	62
Autofocus.....	64
Focus Mode.....	65
Autofocus Options (AF Mode).....	67
Focus-Point Selection.....	69
Manual Focus.....	73
Checking Focus.....	74
📷+ Exposure Compensation.....	75
Focus/Exposure Lock.....	76
The AF-L and AE-L Buttons .....	76







<b>WB</b> White Balance.....	<b>77</b>
WHITE BALANCE.....	78
Custom White Balance.....	79
<b>K</b> : Color Temperature.....	80
<b>Using the Self Timer</b> .....	<b>81</b>
2 SEC/10 SEC.....	82
FACE AUTO SHUTTER.....	83
SMILE.....	83
BUDDY.....	84
GROUP.....	84
<b>Bracketing</b> .....	<b>85</b>
AE BKT.....	86
ISO BKT.....	86
FILM SIMULATION BKT.....	86
WHITE BALANCE BKT.....	86
DYNAMIC RANGE BKT.....	87
HDR.....	87
<b>Continuous Shooting (Burst Mode)</b> .....	<b>88</b>
CONTINUOUS.....	89
4K.....	90
Using the Flash.....	94
Self-Portraits (Selfies).....	96

## **6 The Shooting Menus** **97**

SHOOTING MENU (  /  /  /  /  ).....	<b>98</b>
SCENE POSITION.....	98
ADVANCED FILTER.....	98
AF/MF SETTING.....	98
FOCUS AREA.....	98
FOCUS MODE.....	98
AF MODE.....	98
RELEASE/FOCUS PRIORITY.....	99
AF+MF.....	99
FACE/EYE DETECTION SETTING.....	100
PRE-AF.....	101
AF ILLUMINATOR.....	101



















	RELEASE TYPE .....	101
	ISO.....	102
	IMAGE SIZE .....	103
	IMAGE QUALITY.....	104
	DYNAMIC RANGE .....	105
	FILM SIMULATION .....	106
	FILM SIMULATION BKT .....	107
	SELF-TIMER .....	107
	INTERVAL TIMER SHOOTING .....	108
	TIME-LAPSE MOVIE MODE .....	109
	WHITE BALANCE.....	110
	COLOR .....	110
	SHARPNESS .....	110
	HIGHLIGHT TONE.....	110
	SHADOW TONE.....	111
	NOISE REDUCTION .....	111
	LONG EXPOSURE NR .....	111
	AE BKT SETTING.....	112
	FRAMES/STEP SETTING.....	112
	1 FRAME/CONTINUOUS .....	112
	SEQUENCE SETTING .....	112
	TOUCH SCREEN MODE.....	112
	TOUCH ZOOM.....	112
	MOUNT ADAPTOR SETTING .....	113
	SHOOT WITHOUT LENS.....	115
	MF ASSIST.....	115
	PHOTOMETRY .....	115
	INTERLOCK SPOT AE & FOCUS AREA .....	116
	FLASH SET-UP .....	116
	FLASH MODE .....	116
	FLASH COMPENSATION .....	116
	RED EYE REMOVAL.....	116

 MOVIE SET-UP .....	117
MOVIE MODE .....	117
HD HIGH SPEED VIDEO .....	117
MOVIE ISO .....	118
FOCUS MODE .....	118
AF MODE .....	118
HDMI OUTPUT INFO DISPLAY .....	118
4K MOVIE OUTPUT .....	119
HDMI REC CONTROL .....	119
MIC LEVEL ADJUSTMENT .....	119
MIC/REMOTE RELEASE .....	119
 IS MODE .....	120
 DIGITAL IMAGE STABILIZER .....	120
 WIRELESS COMMUNICATION .....	121
 SHUTTER TYPE .....	121
 ELECTRONIC ZOOM SETTING .....	122















## 7 Playback and the Playback Menu





**123**

The Playback Display .....	124
The DISP/BACK Button .....	125
Viewing Pictures .....	127
Playback Zoom .....	128
Multi-Frame Playback .....	128
The Playback Menu (  /  /  ) .....	129
 IMAGE TRANSFER ORDER .....	129
 WIRELESS COMMUNICATION .....	130
 RAW CONVERSION .....	130
 ERASE .....	132
 CROP .....	134
 RESIZE .....	134
 PROTECT .....	135
 IMAGE ROTATE .....	135
 RED EYE REMOVAL .....	136
 SLIDE SHOW .....	136
 PHOTOBOOK ASSIST .....	137
 PC AUTO SAVE .....	138

 PRINT ORDER (DPOF) .....	139
 instax PRINTER PRINT .....	140
 DISP ASPECT .....	140

## 8 The Setup Menus 141

The Setup Menu (  /  /  ) .....	142
 DATE/TIME .....	142
 TIME DIFFERENCE .....	142
 言語/LANG. ....	142
 RESET .....	143
 SOUND & FLASH .....	143
 SOUND SET-UP .....	144
OPERATION VOL. ....	144
SHUTTER VOLUME .....	144
SHUTTER SOUND .....	144
PLAYBACK VOLUME .....	144
 SCREEN SET-UP .....	145
IMAGE DISP. ....	145
PREVIEW EXP. IN MANUAL MODE .....	145
LCD BRIGHTNESS .....	145
LCD COLOR .....	145
PREVIEW PIC. EFFECT .....	146
FRAMING GUIDELINE .....	146
AUTOROTATE PB. ....	147
FOCUS CHECK .....	147
FOCUS SCALE UNITS .....	147
DISP. CUSTOM SETTING .....	147
 BUTTON SETTING .....	148
FUNCTION (Fn) SETTING .....	148
EDIT/SAVE QUICK MENU .....	148
 FOCUS RING .....	148
 TOUCH SCREEN SETTING .....	148
 POWER MANAGEMENT .....	149
AUTO POWER OFF .....	149
HIGH PERFORMANCE .....	149

 SENSOR CLEANING.....	149
 SAVE DATA SET-UP .....	150
FRAME NO.....	150
SAVE ORG IMAGE.....	150
EDIT FILE NAME .....	151
DATE STAMP.....	151
 COLOR SPACE.....	151
 CONNECTION SETTING.....	152
Bluetooth SETTINGS .....	152
PC AUTO SAVE SETTINGS.....	153
instax PRINTER CONNECTION SETTING.....	153
GENERAL SETTINGS .....	154
INFORMATION .....	154
RESET WIRELESS SETTING.....	154
 FORMAT.....	155

## **9 Shortcuts 157**

Shortcut Options.....	158
The Q (Quick Menu) Button.....	159
The Quick Menu Display .....	159
Viewing and Changing Settings.....	160
Editing the Quick Menu.....	161
The Fn (Function) Button .....	162
Assigning a Role to the Function Button.....	162

## **10 Peripherals and Optional Accessories 163**

Lenses.....	164
Lens Parts .....	164
Power Zoom .....	165
Removing Lens Caps.....	165
Lenses with Lens Hoods.....	165
Lenses with Aperture Rings.....	166
Lenses with O.I.S. Switches.....	166
Manual Focus Lenses.....	167
Lens Care.....	168

<b>11</b>	<b>Connections</b>	<b>169</b>
	HDMI Output.....	170
	Connecting to HDMI Devices .....	170
	Shooting.....	171
	Playback.....	171
	Wireless Transfer.....	172
	Smart Phones and Tablets: FUJIFILM Camera Remote.....	172
	Smart Phones and Tablets: Bluetooth® Pairing.....	173
	Smartphones and Tablets: Wi-Fi.....	173
	Computers: FUJIFILM PC AutoSave.....	174
	Computers: Wireless Connections .....	174
	Connecting to Computers via USB.....	175
	Windows (MyFinePix Studio).....	175
	Mac OS X/macOS.....	175
	RAW FILE CONVERTER EX 2.0.....	175
	Connecting the Camera.....	176
	instax SHARE Printers .....	178
	Establishing a Connection .....	178
	Printing Pictures.....	179
<b>12</b>	<b>Technical Notes</b>	<b>181</b>
	Accessories from FUJIFILM .....	182
	Software from FUJIFILM .....	186
	FUJIFILM Camera Remote .....	186
	FUJIFILM PC AutoSave .....	186
	MyFinePix Studio.....	186
	RAW FILE CONVERTER EX 2.0.....	186
	For Your Safety .....	187
	Product Care .....	196
	Cleaning the Image Sensor .....	197
	Firmware Updates.....	198
	Checking the Firmware Version.....	198
	Troubleshooting.....	199
	Warning Messages and Displays .....	205
	Memory Card Capacity .....	208
	Specifications .....	209

## Supplied Accessories

---

The following are included with the camera:

- NP-W126S rechargeable battery
- AC-5VF/AC-5VG AC power adapter
- Plug adapter (Shape of adapter varies with region of sale.)
- Body cap
- USB cable
- Shoulder strap
- *Owner's Manual* (this manual)



If you purchased a lens kit, check that a lens is included.

## About This Manual

This manual contains instructions for your FUJIFILM X-A5 digital camera. Be sure you have read and understood its contents before proceeding.

### Symbols and Conventions

The following symbols are used in this manual:



Information that should be read to prevent damage to the product.



Additional information that may be helpful when using the product.



Pages on which related information may be found.

Menus and other text in the displays are shown in **bold**. Illustrations are for explanatory purposes only; drawings may be simplified, while photographs are not necessarily taken with the model of camera described in this manual.

### Terminology

The optional SD, SDHC, and SDXC memory cards the camera uses to store pictures are referred to as “memory cards”. The LCD monitor may be referred to as the “LCD”.

# MEMO

---

---

---

---

---

---

---

---

---

---

---

---

---

---

---

---

---

---

---

---

---

---

---

---

---

---



# Before You Begin



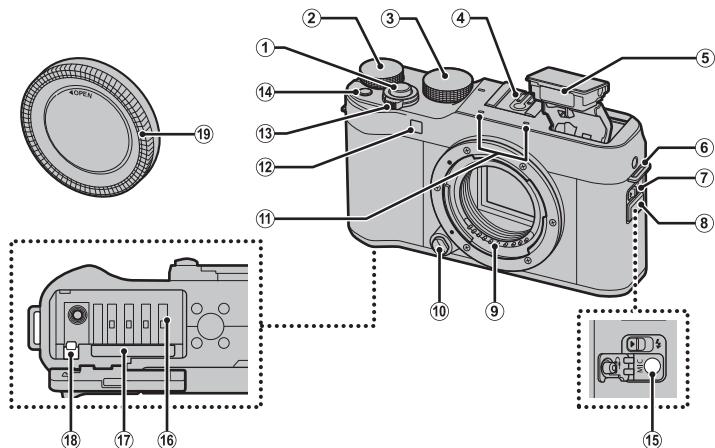

## Parts of the Camera

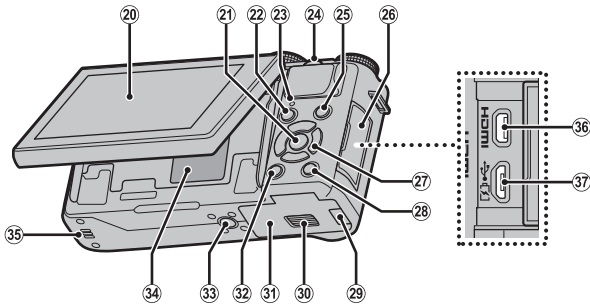

① Shutter button .....	37	⑫ AF-assist illuminator.....	36, 101
② Main command dial.....	6	Self-timer lamp .....	81, 107
③ Mode dial.....	4, 36, 48	⑬ <b>ON/OFF</b> switch .....	29
④ Hot shoe .....	184	⑭ <b>Fn</b> (function) button .....	162
⑤ Flash .....	94, 116	⑮ Microphone/remote release connector	
⑥ Strap eyelet.....	20	(ø2.5 mm) .....	42, 51, 55
⑦ <b>⚡</b> (flash pop-up) switch.....	94	⑯ Battery chamber.....	22
⑧ Connector cover.....	42, 51, 55	⑰ Memory card slot.....	22
⑨ Lens signal contacts.....	21, 164	⑱ Battery latch.....	24
⑩ Lens release button .....	21	⑲ Body cap.....	21
⑪ Microphone.....	42, 119		



- |    |  |                  |    |   |             |
|----|--|------------------|----|---|-------------|
| 20 | LCD monitor .....  | 7, 8             | 29 | Cable channel cover for DC coupler .....        | 22          |
|    | Touch screen .....   | 14, 112, 148     | 30 | Battery-chamber cover latch .....               | 22          |
| 21 | <b>MENU/OK</b> button .....  | 5, 13            | 31 | Battery-chamber cover .....                     | 22          |
|    |  (control lock) button (press and hold) ..... | 5, 9             | 32 | <b>DISP</b> (display)/ <b>BACK</b> button ..... | 10, 125     |
| 22 |  (playback) button .....                      | 38               | 33 | Tripod mount .....                              | 5           |
| 23 | Indicator lamp .....   | 7                | 34 | Serial number plate .....                       | 5           |
| 24 | Sub-command dial .....   | 6, 127           | 35 | Speaker .....                                   | 45, 144     |
| 25 |  (movie recording) button .....               | 42               | 36 | HDMI Micro connector (Type D) .....             | 170         |
| 26 | Connector cover .....  | 51, 55, 170, 176 | 37 | Micro USB (Micro-B) USB 2.0 connector .....     | 51, 55, 176 |
| 27 | Selector .....   | 5                |    |   |             |
| 28 | <b>Q</b> (quick menu) button .....   | 159              |    |   |             |
|    | RAW conversion button (playback mode) .....  | 130              |    |   |             |

## The Mode Dial



To select a shooting mode, rotate the dial until the icon for the desired mode aligns with the index.



Mode	Description	
① <b>SR+ (ADVANCED SR AUTO)</b>	The camera automatically optimizes settings to the scene.	48
② <b>P (PROGRAM AE)</b>	Aperture and shutter speed can be adjusted using program shift.	49
③ <b>S (SHUTTER PRIORITY AE)</b> <b>A (APERTURE PRIORITY AE)</b> <b>M (MANUAL)</b>	Select for full control over camera settings, including aperture ( <b>M</b> and <b>A</b> ) and/or shutter speed ( <b>M</b> and <b>S</b> ).	50 52 53
④ <b>☐ (PANORAMA)</b>	Follow an on-screen guide to create a panorama.	56
⑤ <b>SP (SCENE POSITION)</b> 👤/🏞️/🌃/🌙	Choose a scene suited to the subject or shooting conditions and let the camera do the rest.	59
⑥ <b>Adv. (ADVANCED FILTER)</b>	Take photos with filter effects.	62



## The Selector

Use the ▲▼◀▶ buttons to highlight items or access camera functions.

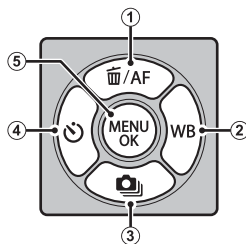
- ① Move cursor up (▲)  
**AF** (autofocus) button .....69  
 (delete) button (playback mode).....39
- ② Move cursor right (▶)  
**WB** (white balance) button .....77
- ③ Move cursor down (▼)  
 (burst shooting) button.....85, 88
- ④ Move cursor left (◀)  
 (self-timer) button.....81
- ⑤ **MENU/OK** button.....13, 97, 129, 141



### Control Lock

To prevent accidental operation of the selector and **Q** button during shooting, press **MENU/OK** until  is displayed. The controls can be unlocked by pressing **MENU/OK** until  is no longer displayed.

## The Serial Number Plate

Do not remove the serial number plate, which provides the FCC ID, KC mark, serial number, and other important information.

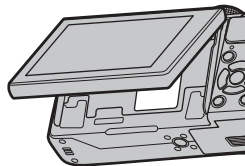

## The Command Dials

The main and sub-command dials are used for the operations listed below.

### Main Command Dial



**Rotate**

- Exposure compensation
- Choose a shutter speed
- Adjust settings in the quick menu
- View other pictures during playback

### Sub-Command Dial



**Rotate**

- Program shift
- Choose a shutter speed
- Adjust aperture <sup>1</sup>
- Adjust power zoom when the monitor is rotated 180° to take self-portraits ("selfies") <sup>2</sup>
- Adjust settings in the quick menu
- Zoom in or out in full-frame or multi-frame playback



**Press**

- Zoom in on selected focus point
- In manual focus mode, press and hold to choose **MF ASSIST** options
- Release shutter when monitor is rotated 180° for self-portraits
- Zoom in on the active focus point during playback

1 Use aperture ring to adjust aperture.

2 Power zoom lens attached and **ON** selected for **ELECTRONIC ZOOM SETTING**.

## The Indicator Lamp

The indicator lamp shows camera status as follows:

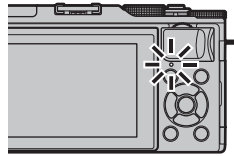

Indicator lamp	Camera status
Glows green	Focus locked.
Blinks green	Focus or slow shutter speed warning. Pictures can be taken.
Blinks green and orange	Recording pictures. Additional pictures can be taken.
Glows orange	Recording pictures. No additional pictures can be taken at this time.
Blinks orange	Flash charging; flash will not fire when picture is taken.
Blinks red	Lens or memory error.

 Warnings may also appear in the display.

## The LCD Monitor

The LCD monitor can be reversed for self-portraits (📖 96) or tilted for ease of viewing, but be careful that your fingers and other objects do not get caught between the monitor and the camera body and avoid touching the wires behind the display. Touching the wires could cause camera malfunction.

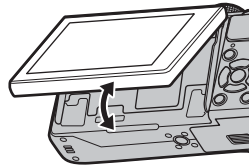

 The LCD monitor also functions as a touch screen (📖 14).

## Camera Displays

This section lists the indicators that may be displayed during shooting.

! For illustrative purposes, displays are shown with all indicators lit.

### The LCD Monitor

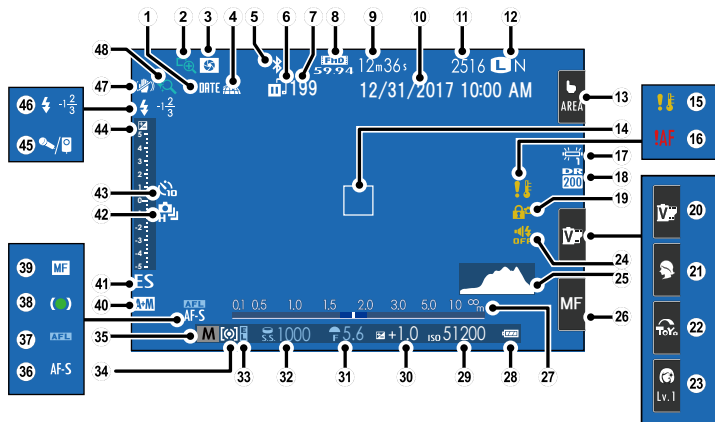



① Date stamp.....	151	②⑥ Focus mode <sup>2</sup> .....	16, 65
② Focus check.....	74, 147	②⑦ Distance indicator.....	74
③ Depth-of-field preview.....	52	②⑧ Battery level.....	30
④ Location data download status.....	154	②⑨ Sensitivity.....	102
⑤ Bluetooth ON/OFF.....	152	③⑩ Exposure compensation.....	75
⑥ Image transfer status.....	129	③① Aperture.....	49, 52, 53
⑦ Number of frames selected for upload .....	129	③② Shutter speed.....	49, 50, 53
⑧ Movie mode.....	42, 117	③③ AE lock.....	76
⑨ Time remaining.....	42	③④ Metering.....	115
⑩ Date and time.....	31, 142	③⑤ Shooting mode.....	4, 48
⑪ Number of available frames <sup>1</sup> .....	208	③⑥ Focus mode.....	65
⑫ Image quality and size.....	103, 104	③⑦ AF lock.....	76
⑬ Touch screen mode <sup>2</sup> .....	14	③⑧ Focus indicator.....	66
⑭ Focus frame.....	69, 76	③⑨ Manual focus indicator.....	73
⑮ Temperature warning.....	207	④⑩ AF+MF indicator.....	99
⑯ Focus warning.....	37	④① Shutter type.....	121
⑰ White balance.....	77, 110	④② Continuous mode.....	88
⑱ Dynamic range.....	105	④③ Self-timer indicator.....	81, 107
⑲ Control lock.....	5	④④ Exposure indicator.....	53, 75
⑳ Film simulation <sup>2</sup> .....	16, 106	④⑤ Microphone/remote release .....	42, 51, 55, 119
㉑ Scene position <sup>2</sup> .....	16, 59	④⑥ Flash mode.....	94
㉒ Advanced filter <sup>2</sup> .....	16, 62	Flash compensation.....	116
㉓ Portrait enhancement level <sup>2</sup> .....	16	④⑦ IS mode.....	120
㉔ Sound and flash indicator.....	143	④⑧ Touch zoom.....	17
㉕ Histogram.....	12		

1 Shows "9999" if there is space for over 9999 frames.

2 Camera functions can also be accessed via touch controls.

### Control Lock

Pressing a locked control displays a  icon.



## Adjusting Display Brightness

Use the items in the  **SCREEN SET-UP** menu to adjust the brightness and hue of the LCD monitor when changes in ambient brightness make the display difficult to read. Choose **LCD BRIGHTNESS** to adjust brightness or **LCD COLOR** to adjust hue.

## The DISP/BACK Button

Press **DISP/BACK** to cycle through display modes as follows.

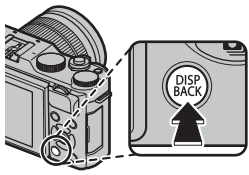

*Standard*

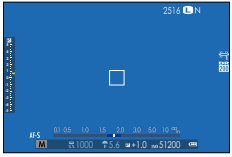

*Information off*



## Customizing the Standard Display

To choose the items shown in the standard display:

- 1 Display standard indicators.**  
Use the **DISP/BACK** button to display standard indicators.
- 2 Select DISP. CUSTOM SETTING.**  
Select  **SCREEN SET-UP > DISP. CUSTOM SETTING** in the setup menu.
- 3 Choose items.**  
Highlight items and press **MENU/OK** to select or deselect.

Item	Default	Item	Default
FRAMING GUIDELINE	<input type="checkbox"/>	SHUTTER TYPE	<input checked="" type="checkbox"/>
ELECTRONIC LEVEL	<input type="checkbox"/>	FLASH	<input checked="" type="checkbox"/>
FOCUS FRAME	<input checked="" type="checkbox"/>	CONTINUOUS MODE	<input checked="" type="checkbox"/>
AF DISTANCE INDICATOR	<input type="checkbox"/>	DUAL IS MODE	<input checked="" type="checkbox"/>
MF DISTANCE INDICATOR	<input checked="" type="checkbox"/>	WHITE BALANCE	<input checked="" type="checkbox"/>
HISTOGRAM	<input type="checkbox"/>	FILM SIMULATION	<input checked="" type="checkbox"/>
SHOOTING MODE	<input checked="" type="checkbox"/>	DYNAMIC RANGE	<input checked="" type="checkbox"/>
APERTURE/S-SPEED/ISO	<input checked="" type="checkbox"/>	FRAMES REMAINING	<input checked="" type="checkbox"/>
INFORMATION BACKGROUND	<input checked="" type="checkbox"/>	IMAGE SIZE/QUALITY	<input checked="" type="checkbox"/>
Expo. Comp. (Digit)	<input type="checkbox"/>	MOVIE MODE & REC. TIME	<input checked="" type="checkbox"/>
Expo. Comp. (Scale)	<input checked="" type="checkbox"/>	AUTO IMAGE TRANSFER	<input checked="" type="checkbox"/>
FOCUS MODE	<input checked="" type="checkbox"/>	BATTERY LEVEL	<input checked="" type="checkbox"/>
PHOTOMETRY	<input checked="" type="checkbox"/>		

- 4 Save changes.**  
Press **DISP/BACK** to save changes.
- 5 Exit the menus.**  
Press **DISP/BACK** as needed to exit the menus and return to the shooting display.

### Virtual Horizon

Selecting **ELECTRONIC LEVEL** displays a virtual horizon. The camera is level when the two lines overlap. Note that the virtual horizon may not be displayed if the camera lens is pointed up or down.

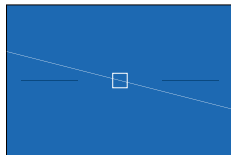

### Histograms

Histograms show the distribution of tones in the image. Brightness is shown by the horizontal axis, the number of pixels by the vertical axis.

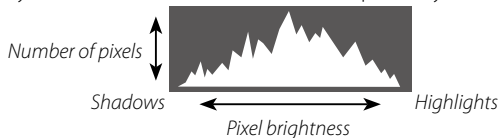

- **Optimal exposure:** Pixels are distributed in an even curve throughout the tone range.
- **Overexposed:** Pixels are clustered on the right side of the graph.
- **Underexposed:** Pixels are clustered on the left side of the graph.

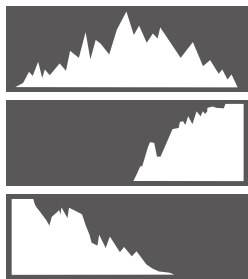

## Using the Menu

To display the menu, press **MENU/OK**.

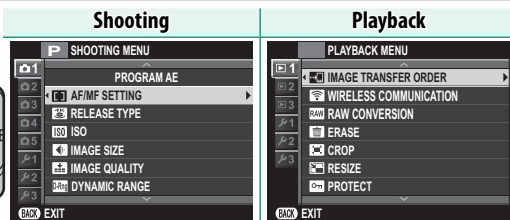
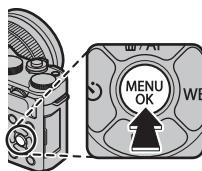

To navigate the menus:

- 1 Press **MENU/OK** to display the menus.

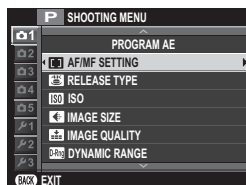

- 2 Press the selector left to highlight the tab for the current menu.



*Tab*

- 3 Press the selector up or down to highlight the tab (**1**, **2**, **3**, **4**, **5**, **1**, **2**, **3**, **1**, **2** or **3**) containing the desired item.
- 4 Press the selector right to place the cursor in the menu.

## Touch Screen Mode

The camera's LCD monitor can be used as a touch screen.

### Shooting Touch Controls



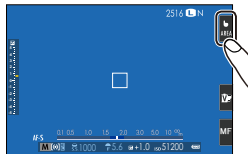

Touch controls can be used for such operations as choosing the focus area and taking photographs. The operation performed can be selected by tapping the touch screen mode indicator in the display to cycle through the following options.







Touch control settings can be adjusted using the **TOUCH SCREEN MODE** option in the shooting menu.

The touch screen mode indicator is not displayed and touch controls cannot be used when **OFF** is selected for **TOUCH SCREEN SETTING** in the setup menu.

### Still Photography

Mode	Description
 <b>TOUCH SHOOTING</b>	Tap your subject in the display to focus and release the shutter. In burst mode, pictures will be taken while you keep your finger on the display.
 <b>AF</b>	Tap to select a focus point and lock focus. The shutter can be released by pressing the shutter button all the way down.
 <b>AREA</b>	Tap to select a point for focus or zoom. The focus frame will move to the selected point.
 <b>OFF</b>	Touch controls off. The display does not respond when tapped.

## Movie Recording





Mode	Description
 <b>TOUCH SHOOTING</b>	Tap your subject in the display to focus. In focus mode <b>CONTINUOUS AF</b> (AF-C), the camera will continually adjust focus in response to changes in the distance to the subject; to refocus in focus mode <b>SINGLE AF</b> (AF-S) or to focus on a new subject in focus mode <b>CONTINUOUS AF</b> , tap the subject in the monitor.
 <b>AF</b>	Tap to select a focus point. If <b>SINGLE AF</b> (AF-S) is selected for focus mode, the camera will focus on the subject in the selected focus point when the shutter button is pressed halfway. In focus mode <b>CONTINUOUS AF</b> (AF-C), the camera will continually adjust focus in response to changes in the distance to the subject in the selected focus point.
 <b>AREA</b>	Tap to select a focus point. If <b>SINGLE AF</b> (AF-S) is selected for focus mode, the camera will focus on the subject in the selected focus point when the shutter button is pressed halfway. In focus mode <b>CONTINUOUS AF</b> (AF-C), the camera will continually adjust focus in response to changes in the distance to the subject in the selected focus point.
 <b>OFF</b>	Touch controls off. The display does not respond when tapped.

 We recommend that you select **AREA** for **MOVIE SET-UP > AF MODE** in the shooting menu before recording movies using touch controls (in some movie modes, **AREA** will be selected automatically).

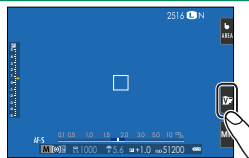
## Adjusting Settings

The touch screen can be used to adjust settings. The settings available vary with the shooting mode.



Mode	Description
 <b>FILM SIMULATION</b>	Choose a film simulation type. Available in <b>SR<sup>+</sup></b> , <b>P</b> , <b>S</b> , <b>A</b> , and <b>M</b> modes.
 <b>SCENE POSITION</b>	Choose a scene. Available in <b>SP</b> mode.
 <b>ADVANCED FILTER</b>	Choose an advanced filter. Available in <b>Adv.</b> mode.
 <b>PORTRAIT ENHANCER</b>	Choose the portrait enhancement level. Available in <b>PORTRAIT ENHANCER (Lv.1)</b> mode.

## Choosing a Focus Mode

The touch screen can be used to choose the focus mode (📖 65).





## Touch Zoom

Touch controls can be used for digital zoom, regardless of the mode selected for **TOUCH SCREEN MODE** in the shooting menu.

- 1 Select **ON** for **TOUCH ZOOM** in the shooting menu.
- 2 Use pinch-out and pinch-in gestures (📖 18) to zoom in and out using digital zoom.

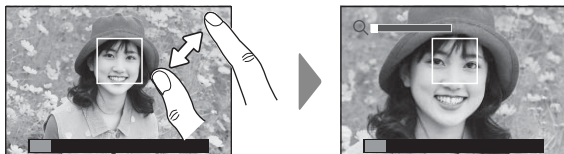

- Regardless of where you place your fingers, the camera will zoom in on and out from the center of the frame.

The camera will focus on the area selected for **AF/MF SETTING > FOCUS AREA**. If **AREA** is selected for **TOUCH SCREEN MODE**, you can select the focus area by tapping the display.

- 3 Take pictures.

## Playback Touch Controls

When **ON** is selected for **TOUCH SCREEN SETTING** in the set-up menu, touch controls can be used for the following playback operations:

- **Swipe:** Swipe a finger across the display to view other images.



- **Pinch-out:** Place two fingers on the display and spread them apart to zoom in.



- **Pinch-in:** Place two fingers on the display and slide them together to zoom out.

 Pictures can be zoomed out until the entire image is visible but no further.



- **Double-tap:** Tap the display twice to zoom in on the focus point.



- **Drag:** View other areas of the image during playback zoom.

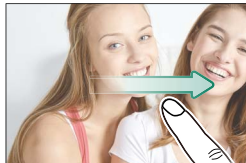

# First Steps

# 2

## Attaching the Shoulder Strap

Attach the strap to the two strap eyelets as shown below.

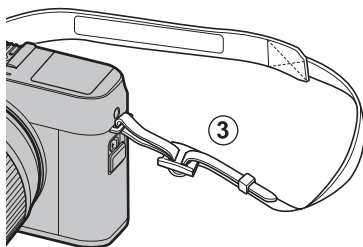
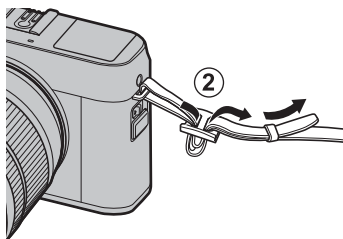
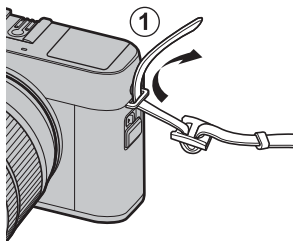

**!** Attach the strap as shown.

To avoid dropping the camera, be sure the strap is correctly secured.

## Attaching a Lens

The camera can be used with lenses for the FUJIFILM X-mount.

Remove the body cap from the camera and the rear cap from the lens. Place the lens on mount, keeping the marks on the lens and camera aligned (①), and then rotate the lens until it clicks into place (②).

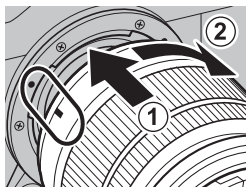

ⓘ When attaching lenses, ensure that dust or other foreign matter does not enter the camera and be careful not to touch the camera's internal parts. Do not press the lens release button while attaching the lens and be sure the latch has securely clicked into place.

### Removing Lenses

To remove the lens, turn the camera off, then press the lens release button (①) and rotate the lens as shown (②).

ⓘ To prevent dust accumulating on the lens or inside the camera, replace the lens caps and camera body cap when the lens is not attached.

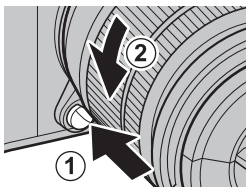

### Lenses and Other Optional Accessories

The camera can be used with lenses and accessories for the FUJIFILM X-mount.

ⓘ Before attaching or removing (exchanging) lenses, attach the lens caps and check that the lenses are free of dust and other foreign matter. Do not change lenses in direct sunlight or under another bright light source, as light focused into the interior of the camera could cause it to malfunction.

## Inserting the Battery and a Memory Card

Insert the battery and memory card as described below.

### 1 Open the battery-chamber cover.

Slide the battery-chamber latch as shown and open the battery-chamber cover.

**!** Do not remove the battery when the camera is on. Failure to observe this precaution could damage image files or memory cards.

Do not use excessive force when handling the battery-chamber cover.

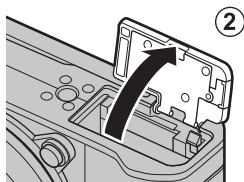
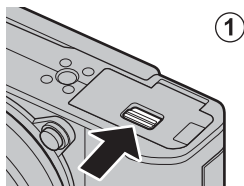

### 2 Insert the battery.

Using the battery to keep the battery latch pressed to one side, insert the battery contacts first in the direction shown by the arrow. Confirm that the battery is securely latched.

**!** Insert the battery in the orientation shown. *Do not use force or attempt to insert the battery upside down or backwards.* The battery will slide in easily in the correct orientation.

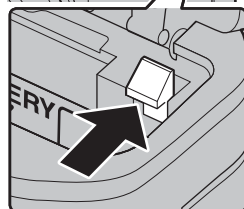
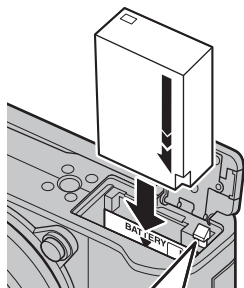

**3 Insert the memory card.**

Holding the card in the orientation shown, slide it in until it clicks into place at the back of the slot.

**!** Be sure card is in the correct orientation; do not insert at an angle or use force.

Format memory cards before first use, and be sure to reformat all memory cards after using them in a computer or other device.

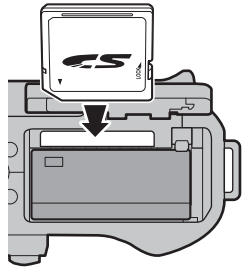
**4 Close the battery-chamber cover.**

Close and latch the cover.

**!** If the cover does not close, check that the battery is in the correct orientation. Do not attempt to force the cover shut.

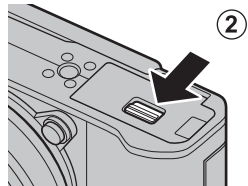
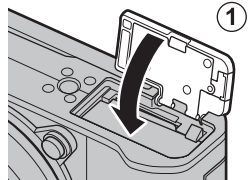

## Removing the Battery and Memory Card

Before removing the battery or memory card, *turn the camera off* and open the battery-chamber cover.

To remove the battery, press the battery latch to the side, and slide the battery out of the camera as shown.

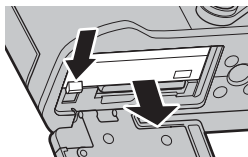

**!** The battery may become hot when used in high-temperature environments. Observe caution when removing the battery.

To remove the memory card, press it in and release it slowly. The card can then be removed by hand. When a memory card is removed, the card could be ejected too quickly. Use your finger to hold it and gently release the card.

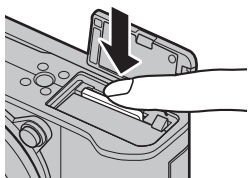

**!** Press the center of the card when ejecting it.



## Compatible Memory Cards

FUJIFILM and SanDisk SD, SDHC, and SDXC memory cards have been approved for use in the camera; UHS-I cards are supported, while cards with a UHS speed class of 3 or better are recommended for 4K burst, multi-focus, and movie modes. A complete list of approved memory cards is available at [http://www.fujifilm.com/support/digital\\_cameras/compatibility/](http://www.fujifilm.com/support/digital_cameras/compatibility/). Operation is not guaranteed with other cards. The camera cannot be used with xD-Picture Cards or MultiMediaCard (MMC) devices.

**!** *Do not turn the camera off or remove the memory card while the memory card is being formatted or data are being recorded to or deleted from the card. Failure to observe this precaution could damage the card.*

Memory cards can be locked, making it impossible to format the card or to record or delete images. Before inserting a memory card, slide the write-protect switch to the unlocked position.

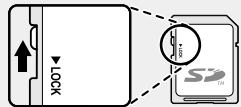

Memory cards are small and can be swallowed; keep out of reach of children. If a child swallows a memory card, seek medical assistance immediately.

miniSD or microSD adapters that are larger or smaller than memory cards may not eject normally; if the card does not eject, take the camera to an authorized service representative. Do not forcibly remove the card.

Do not affix labels or other objects to memory cards. Peeling labels can cause camera malfunction.

Movie recording may be interrupted with some types of memory card.

When you first take a picture after formatting a memory card in the camera, the camera will create a folder in which the new shot and subsequent. Do not rename or delete this folder or use a computer or other device to edit, delete, or rename image files. Always use the camera to delete pictures; before editing or renaming files, copy them to a computer and edit or rename the copies, not the originals. Renaming the files on the camera can cause problems during playback.

## Charging the Battery

The battery is not charged at shipment. Turn the camera off and charge the battery before use. The camera charges the battery internally.

**!** An NP-W126S rechargeable battery is supplied with the camera. Charging takes about 210 minutes.

### 1 Attach the plug adapter to the AC power adapter.

Attach the plug adapter as shown, making sure that it is fully inserted and clicks into place on the AC power adapter terminals.

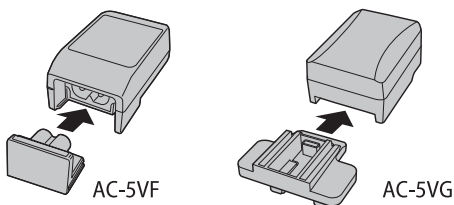

**!** The plug adapter is exclusively for use with the supplied AC power adapter. Do not use it with other devices.

### 2 Charge the battery.

Connect the camera to the supplied AC power adapter using the supplied USB cable. Then plug the AC power adapter into an indoor power outlet.

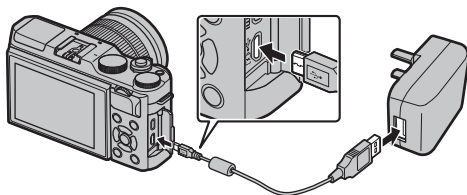

**!** Connect the cable to the camera's Micro USB (Micro-B) connector. Be sure the connectors are in the correct orientation and then insert them fully.

**Charge Status**

The indicator lamp shows battery charge status as follows:

Indicator lamp	Battery status
On	Battery charging.
Off	Charging complete.
Blinks	Battery fault.

 The battery will not charge while the camera is on.

Use the charger with the plug adapter for your country or region.

Do not affix labels or other objects to the battery. Failure to observe this precaution could make it impossible to remove the battery from the camera.

Do not short the battery terminals. The battery could overheat.

Read the cautions in "The Battery and Power Supply".

Use only battery chargers designated for use with the battery. Failure to observe this precaution could result in product malfunction.

Do not remove the labels from the battery or attempt to split or peel the outer casing.

The battery gradually loses its charge when not in use. Charge the battery one or two days before use. If the battery fails to hold a charge, it has reached the end of its charging life and must be replaced.

Unplug the AC power adapter from the power outlet when it is not in use.

Remove dirt from the battery terminals with a clean, dry cloth. Failure to observe this precaution could prevent the battery from charging.

Charging times may increase at very low or very high temperatures.

### Charging via Computer

The battery can be charged by connecting the camera to a computer. Connect the supplied USB cable as shown, making sure the connectors are fully inserted.

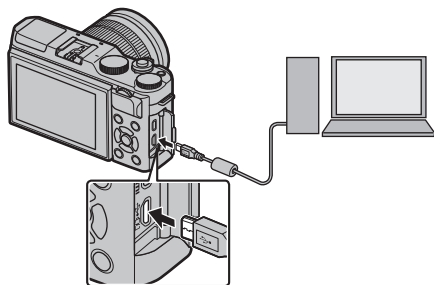



- The battery will not charge while the camera is on.
- Connect the cable to the camera's Micro USB (Micro-B) connector.
- Connect the camera directly to the computer; do not use a USB hub or keyboard.
- Charging stops if the computer enters sleep mode; to resume charging, activate the computer and disconnect and reconnect the USB cable.
- Charging may not be supported depending on the model of computer, computer settings, and the computer's current state.

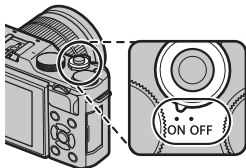

## Turning the Camera On and Off

Use the **ON/OFF** switch to turn the camera on and off.

Rotate the switch to **ON** to turn the camera on, or to **OFF** to turn the camera off.



 Fingerprints and other marks on the lens can affect pictures and the view through the lens in the camera display. Keep the lens clean.

 Press the  button to start playback. Press the shutter button halfway to return to shooting mode.

The camera will turn off automatically if no operations are performed for the length of time selected for  **POWER MANAGEMENT** > **AUTO POWER OFF**. To reactivate the camera after it has turned off automatically, press the shutter button halfway or turn the **ON/OFF** switch to **OFF** and then back to **ON**.





Selecting **HIGH PERFORMANCE** for  **POWER MANAGEMENT** reduces startup time.

## Checking the Battery Level

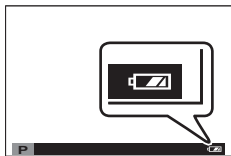
After turning the camera on, check the battery level in the display.

Battery level is shown as follows:



Indicator	Description
 (white)	Battery partially discharged.
 (white)	Battery about two-thirds charged.
 (white)	Battery about one-third charged. Charge as soon as possible.
 (red)	Low battery. Charge battery.
 (blinks red)	Battery exhausted. Turn camera off and recharge battery.

## Basic Setup

When you turn the camera on for the first time, you can choose a language and set the camera clock. At default settings, you can also pair the camera with a smartphone or tablet so that you can later synchronize the clocks or download pictures. Follow the steps below when turning the camera on for the first time.

 If you intend to pair the camera with a smartphone or tablet, install and launch the latest version of the FUJIFILM Camera Remote App on the smart device before proceeding. For more information, visit: [http://app.fujifilm-dsc.com/en/camera\\_remote/](http://app.fujifilm-dsc.com/en/camera_remote/)

### 1 Turn the camera on.

A language-selection dialog will be displayed.

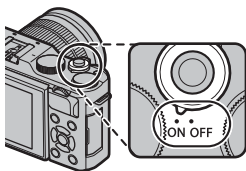

### 2 Choose a language.

Highlight a language and press **MENU/OK**.

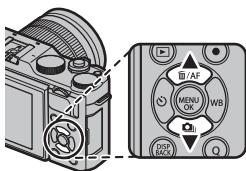

### 3 Pair the camera with the smartphone or tablet.



Press **MENU/OK** to pair the camera with a smartphone or tablet running the FUJIFILM Camera Remote app.

 To skip pairing, press **DISP/BACK**.



#### 4 Check the time.

When pairing is complete, you will be prompted to set the camera clock to the time reported by the smartphone or tablet. Check that the time is correct.

 To set the clock manually, press **DISP/BACK** (  33).

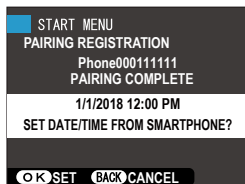

#### 5 Synchronize the camera settings with the settings configured on your smartphone or tablet.

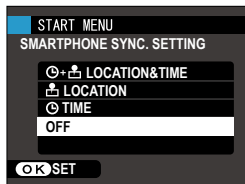

#### 6 Set the clock.

Press **MENU/OK** to set the camera clock to the time reported by the smartphone or tablet and exit to shooting mode.

 If the battery is removed for an extended period, the camera clock will be reset and the language-selection dialog will be displayed when the camera is turned on.

#### **Skiping the Current Step**

Press **DISP/BACK** to skip the current step. A confirmation dialog will be displayed; select **NO** to avoid repeating any steps you skipped the next time the camera is turned on.



## Choosing a Different Language

To change the language:

- 1 Display language options.**  
Display the setup menu and select  言語/LANG..
- 2 Choose a language.**  
Highlight the desired option and press **MENU/OK**.

## Changing the Time and Date

To set the camera clock:

- 1 Display DATE/TIME options.**  
Display the setup menu and select  DATE/TIME.
- 2 Set the clock.**  
Press the selector left or right to highlight the year, month, day, hour, or minute and press up or down to change. Press **MENU/OK** to set the clock.

# MEMO

---

---

---

---

---

---

---

---

---

---

---

---

---

---

---

---

---

---

---

---

---

---

---

---

---

---

---

---

---

---

# Basic Photography and Playback

# 3

## Taking Photographs

This section explains basic photography.

### 1 Select **SR+** mode.

Rotate the mode dial to **SR+** (ADVANCED SR AUTO). The following information will be displayed in the LCD monitor.

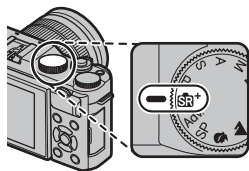

- 1 Scene Icon:** The camera automatically selects the appropriate scene.
- 2 The  Icon:** Shows that the camera is focusing on the subjects' eyes.



**!** In **SR+** mode, the camera continuously adjusts focus and searches for eyes, increasing the drain on the battery; in addition, the sound of the camera focusing may be audible.

### 2 Ready the camera.

Hold the camera steady with both hands and brace your elbows against your sides. Shaking or unsteady hands can blur your shots.

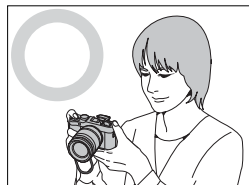

To prevent pictures that are out of focus or too dark (underexposed), keep your fingers and other objects away from the lens, flash, and AF-assist illuminator.

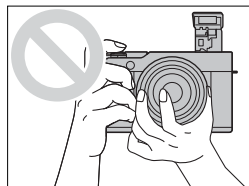

### 3 Frame the picture.

#### Lenses with Zoom Rings

Use the zoom ring to frame the picture in the display. Rotate the ring left to zoom out, right to zoom in.

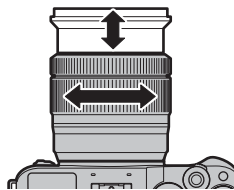

### 4 Focus.

Press the shutter button halfway to focus.

 If the subject is poorly lit, the AF-assist illuminator may light.



Focus indicator

Focus frame

**If the camera is able to focus**, it will beep twice and focus area and focus indicator will glow green. Focus and exposure will lock while the shutter button is pressed halfway.

**If the camera is unable to focus**, the focus frame will turn red, **!AF** will be displayed, and the focus indicator will blink white.

### 5 Shoot.

Smoothly press the shutter button the rest of the way down to take the picture.



## Viewing Pictures

Pictures can be viewed in the LCD monitor.

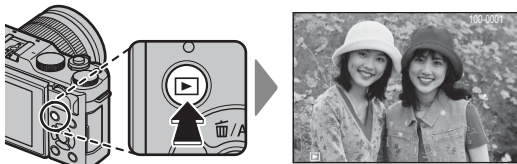
To view pictures full frame, press .



Additional pictures can be viewed by pressing the selector left or right or rotating the main command dial. Press the selector or rotate the dial right to view pictures in the order recorded, left to view pictures in reverse order. Keep the selector pressed to scroll rapidly to the desired frame.

 Pictures taken using other cameras are marked with a  ("gift image") icon to warn that they may not display correctly and that playback zoom may not be available.



## Deleting Pictures

Use the (▲) button to delete pictures.



Deleted pictures cannot be recovered. Copy important pictures to a computer or other storage device before proceeding.

- 1 With a picture displayed full frame, press the button and select **FRAME**.

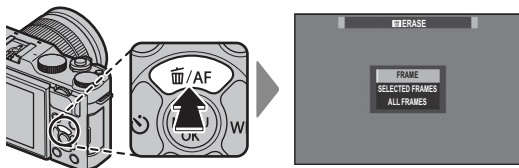

- 2 Press the selector left or right to scroll through pictures and press **MENU/OK** to delete (a confirmation dialog is not displayed). Repeat to delete additional pictures.



Protected pictures cannot be deleted. Remove protection from any pictures you wish to delete ( 135).

Pictures can also be deleted by **ERASE** from playback menu ( 132).

**MEMO**

---

---

---

---

---

---

---

---

---

---

---

---

---

---

---

---

---

---

---

---

---

---

---

---

---

---

---

---

---



# Movie Recording and Playback

# 4



## Recording Movies

Record movies with sound.

- 1 Press  to start recording.

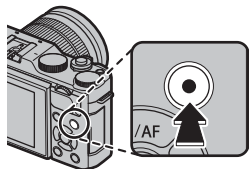

A recording indicator () and the time remaining are displayed while recording is in progress.



- 2 To end recording, press the  button again. Recording ends automatically when the maximum length is reached or the memory card is full.

### Using an External Microphone

Sound can be recorded with external microphones that connect using jacks 2.5 mm in diameter; microphones that require plug-in power cannot be used. See the microphone manual for details.

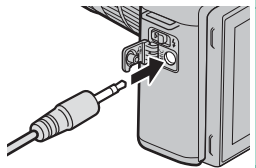

 Use a memory card with a UHS speed class of 3 or better when recording movies.

Touch zoom is not available during movie recording.

The area recorded when **ON** is selected for  **DIGITAL IMAGE STABILIZER** is smaller than that shown in the monitor.

Sound is recorded via the built-in microphone or an optional external microphone. Do not cover the microphone during recording. Note that the microphone may pick up lens noise and other sounds made by the camera during recording.

Vertical or horizontal streaks may appear in movies containing very bright subjects. This is normal and does not indicate a malfunction.

 The indicator lamp lights while recording is in progress. During recording, you can change exposure compensation by up to  $\pm 2$  EV and adjust zoom using the zoom ring on the lens (if available).

Recording may be unavailable at some settings, while in other cases settings may not apply during recording.

## Adjusting Movie Settings

- Adjust movie settings in the **MOVIE SET-UP** menu.
- The movie type, frame size, and frame rate can be selected using **MOVIE SET-UP > MOVIE MODE**.
- The AF-area mode for movie recording is selected using **MOVIE SET-UP > AF MODE**; choose from **MULTI** and **AREA**.
- Focus mode is selected using **MOVIE SET-UP > FOCUS MODE**; for continuous focus adjustment, select **CONTINUOUS AF** or choose **SINGLE AF** and enable Intelligent Face Detection. Intelligent Face Detection is not available in manual focus mode.

### Depth of Field

Manual aperture adjustment is available in shooting modes **A** and **M**; adjust aperture before recording begins. Choose low f-numbers to soften background details. The effect can be heightened by increasing the distance between your subject and the background.

## Viewing Movies

View movies on the camera.

In full-frame playback, movies are identified by a  icon. Press the selector down to start movie playback.



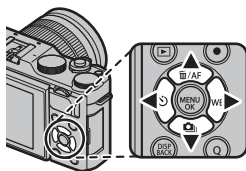

The following operations can be performed while a movie is displayed:





Selector	Full-frame playback	Playback in progress (▶)	Playback paused (⏸)
▲	—	End playback	
▼	Start playback	Pause playback	Start/resume playback
◀▶	View other pictures	Adjust speed	Single frame rewind/ advance

Progress is shown in the display during playback.



 Do not cover the speaker during playback. Sound is not played back if **OFF** is selected for  **SOUND & FLASH**.

 Press **MENU/OK** to pause playback and display volume controls. Press the selector up or down to adjust the volume; press **MENU/OK** again to resume playback. Volume can also be adjusted from the setup menu ( 144).

**Playback Speed**

Press the selector left or right during playback to adjust playback speed. Speed is shown by the number of arrows (▶ or ◀).

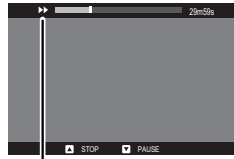

Arrows

# Taking Photographs

5

## Choosing a Shooting Mode

Choose a shooting mode according to the scene or type of subject.

### SR<sup>+</sup> ADVANCED SR AUTO

When the mode dial is rotated to SR<sup>+</sup>, the camera automatically optimizes settings to suit the scene.

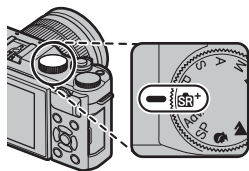

The scene is shown by an icon in the display.



Icon	Scene	Icon	Scene
(○)	AUTO	(○)  (○)	MACRO
(○)  (○)	PORTRAIT	(○)  (○)  (○)	NIGHT PORTRAIT
(○)  (○)  (○)	LANDSCAPE	(○)  (○)	BACKLIT PORTRAIT
(○)  (○)  (○)	NIGHT		

\* The scenes in parentheses are selected if the camera detects that the subject is moving.

The mode selected may vary with shooting conditions. If the mode and subject do not match, select mode **P** or choose **SP** and select a scene manually.



## Program AE (P)

Let the camera choose shutter speed and aperture for optimal exposure. Other values that produce the same exposure can be selected with program shift.

Rotate the mode dial to P.

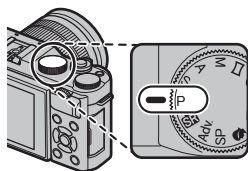

P will appear in the display.

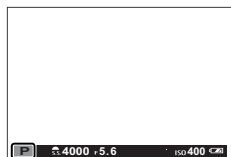

### Program Shift

Rotate the sub-command dial to choose the desired combination of shutter speed and aperture (program shift).

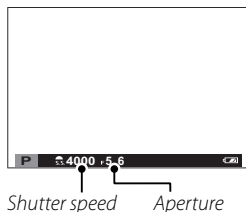

⚠ Program shift is not available if the attached flash supports TTL auto, or if an auto option is selected for **D-Ring DYNAMIC RANGE** in the shooting menu.

🔌 To cancel program shift, turn the camera off.

## Shutter-Priority AE (S)

Choose a shutter speed and let the camera adjust aperture for optimal exposure.

- 1 Rotate the mode dial to S.

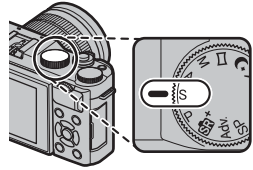

S will appear in the display.

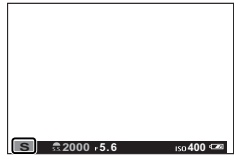

- 2 Use the sub-command dial to choose a shutter speed.

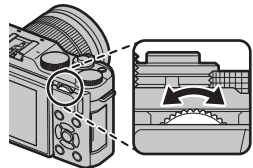



**!** If the correct exposure cannot be achieved at the selected shutter speed, aperture will be displayed in red.

## Time (T)

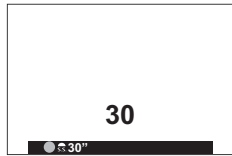
Shutter speeds of 1 s or slower are referred to as “long time-exposures”. Use of a tripod is recommended to prevent the camera moving during the exposure.



 A count-down timer will be displayed while the exposure is in progress.

To reduce “noise” (mottling) in long time-exposures, select **ON** for  **LONG EXPOSURE NR**. Note that this may increase the time needed to record images after shooting.

### Using a Remote Release

An optional RR-90 remote release can be used for long time-exposures. The RR-90 connects via the Micro USB (Micro-B) USB 2.0 connector.

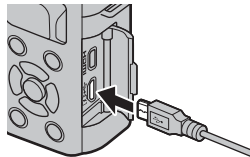

Alternatively, electronic releases from third-party suppliers can be connected via the remote release connector (ø2.5 mm 3-pole mini jack).

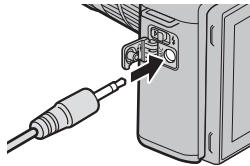

 A confirmation dialog will be displayed when a third-party release is connected; press **MENU/OK** and select **REMOTE** for  **MOVIE SET-UP > MIC/REMOTE RELEASE**.

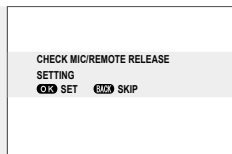

## Aperture-Priority AE (A)

Choose an aperture and let the camera adjust shutter speed for optimal exposure.

- 1 Rotate the mode dial to **A**.

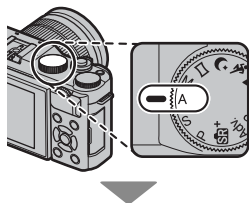

A will appear in the display.



- 2 Use the sub-command dial to choose an aperture.

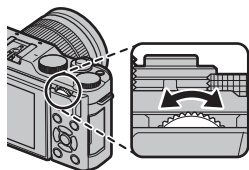

**!** If the correct exposure cannot be achieved at the selected aperture, shutter speed will be displayed in red.

### Previewing Depth of Field

When **PREVIEW DEPTH OF FIELD** is assigned to a function button, pressing the button displays a  icon and stops aperture down to the selected setting, allowing depth of field to be previewed when the view through the lens appears in the display.



## Manual Exposure (M)

Alter exposure from that selected by the camera.

- 1 Rotate the mode dial to M.

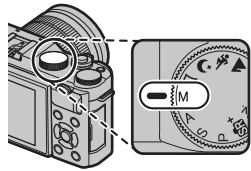

M will appear in the display.

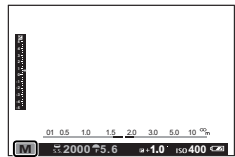

- 2 Rotate the main command dial to choose a shutter speed and the sub-command dial to choose the aperture.



The manual exposure display includes an exposure indicator that shows the amount the picture would be under- or over-exposed at current settings.

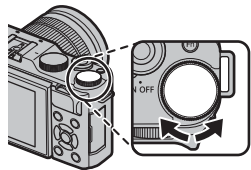

*Shutter speed*

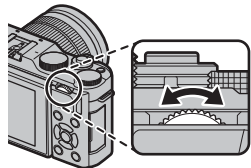

*Aperture*

## Exposure Preview

To preview exposure in the LCD monitor, select **ON** for  **SCREEN SET-UP > PREVIEW EXP. IN MANUAL MODE**. Select **OFF** when using the flash or on other occasions on which exposure may change when the picture is taken.



## Bulb (B)

For bulb photography, rotate the main command dial to select a shutter speed of **BULB**. Use of a tripod is recommended to prevent the camera moving during the exposure.

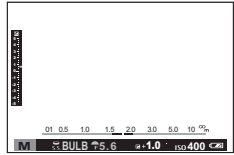

The shutter will remain open for up to 60 seconds, or for 1 second when the electronic shutter is used.

A count-down timer will be displayed while the exposure is in progress.

To reduce "noise" (mottling) in long time-exposures, select **ON** for **LONG EXPOSURE NR.** Note that this may increase the time needed to record images after shooting.

### Using a Remote Release

An optional RR-90 remote release can be used for long time-exposures. The RR-90 connects via the Micro USB (Micro-B) USB 2.0 connector.

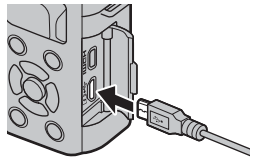

Alternatively, electronic releases from third-party suppliers can be connected via the remote release connector (ø2.5 mm 3-pole mini jack).

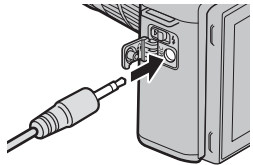

A confirmation dialog will be displayed when a third-party release is connected; press **MENU/OK** and select **REMOTE** for **MOVIE SET-UP > MIC/REMOTE RELEASE.**

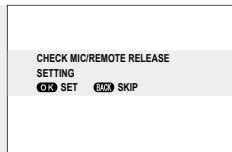

## ☐ PANORAMA

Follow an on-screen guide to create a panorama.

- 1 Rotate the mode dial to ☐ (PANORAMA).

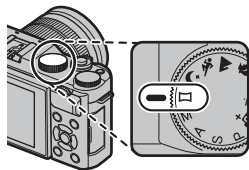

- 2 To select the size of the angle through which you will pan the camera while shooting, press the selector left. Highlight a size and press **MENU/OK**.
- 3 Press the selector right to view a choice of pan directions. Highlight a pan direction and press **MENU/OK**.
- 4 Press the shutter button all the way down to start recording. There is no need to keep the shutter button pressed during recording.

- 5 Pan the camera in the direction shown by the arrow. Shooting ends automatically when the camera is panned to the end of the guides and the panorama is complete.

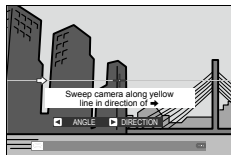

### For Best Results

For best results, use a lens with a focal length of 35 mm or less (50mm or less in 35 mm format). Prop your elbows against your sides and move the camera slowly in a small circle at a steady speed, keeping the camera parallel or at right angles to the horizon and being careful only to pan in the direction shown by the guides. Use a tripod for best results. If the desired results are not achieved, try panning at a different speed.



 Shooting ends if the shutter button is pressed all the way down during shooting. No panorama may be recorded if the shutter button is pressed before the panorama is complete.

Panoramas are created from multiple frames; exposure for the entire panorama is determined by the first frame. The camera may in some cases record an greater or lesser angle than selected or be unable to stitch the frames together perfectly. The last part of the panorama may not be recorded if shooting ends before the panorama is complete.

Shooting may be interrupted if the camera is panned too quickly or too slowly. Panning the camera in a direction other than that shown cancels shooting.

The desired results may not be achieved with moving subjects, subjects close to the camera, unvarying subjects such as the sky or a field of grass, subjects that are in constant motion, such as waves and waterfalls, or subjects that undergo marked changes in brightness. Panoramas may be blurred if the subject is poorly lit.

## Viewing Panoramas

In full-frame playback, you can use the sub-command to zoom panoramas in or out. Alternatively, you can play the panorama back using the selector.

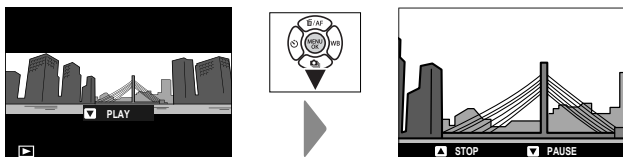

Press the selector down to start playback and press again to pause. Press the selector left or right to choose the pan direction while playback is in progress or to scroll the panorama manually while playback is paused; vertical panoramas will scroll vertically, horizontal panoramas horizontally. To exit to full-frame playback, press the selector up. To view other images, exit to full-frame playback and press the selector left or right.



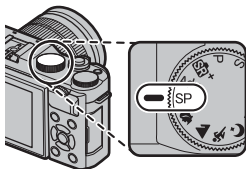

**SP SCENE POSITION** /  /  /  / 

The camera offers a choice of “scenes,” each adapted to particular shooting conditions or a specific type of subject.

- 1 Rotate the mode dial to **SP (SCENE POSITION)**.



The following scenes can be selected directly using the mode dial:





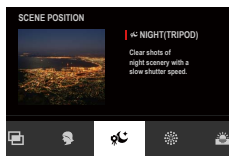





Scene	Description
 <b>PORTRAIT ENHANCER</b> (⊕)	Choose for a smooth skin effect when shooting portraits. If <b>ON</b> is selected for  <b>TOUCH SCREEN SETTING</b> , you can choose the portrait enhancement level using touch controls.
 <b>LANDSCAPE</b>	Choose for daylight shots of buildings and landscapes.
 <b>SPORT</b>	Choose when photographing moving subjects.
 <b>NIGHT</b>	Choose for poorly lit twilight or night scenes.

- 2 Press **MENU/OK** while the mode description is displayed.



-  If the view through the lens is displayed in the LCD monitor, press **MENU/OK** and select  **SCENE POSITION** in the shooting menu.

### 3 Highlight one of the following options and press **MENU/OK**.

Scene	Description
 <b>PORTRAIT</b>	Choose for portraits.
 <b>NIGHT (TRIPOD)</b>	Choose this mode for slow shutter speeds when shooting at night.
 <b>FIREWORKS</b>	Slow shutter speeds are used to capture the expanding burst of light from a firework.
 <b>SUNSET</b>	Choose this mode to record the vivid colors in sunrises and sunsets.
 <b>SNOW</b>	Choose for crisp, clear shots that capture the brightness of scenes dominated by shining white snow.
 <b>BEACH</b>	Choose for crisp, clear shots that capture the brightness of sunlit beaches.
 <b>PARTY</b>	Capture indoor background lighting under low-light conditions.
 <b>FLOWER</b>	Effective for taking more vivid shots of flowers.
 <b>TEXT</b>	Take clear pictures of text or drawings in print.
 <b>MULTIPLE EXPOSURE</b>	Create a photograph that combines two exposures (  61).

## Multiple Exposures

Create a photograph that combines two exposures.



- 1 Select  **MULTIPLE EXPOSURE** in the scene position menu.
- 2 Take the first shot.
- 3 Press **MENU/OK**. The first shot will be shown superimposed on the view through the lens and you will be prompted to take the second shot.

 To return to Step 2 and retake the first shot, press the selector left. To save the first shot and exit without creating a multiple exposure, press **DISP/BACK**.

- 4 Take the second shot, using the first frame as a guide.
- 5 Press **MENU/OK** to create the multiple exposure, or press the selector left to return to Step 4 and retake the second shot.

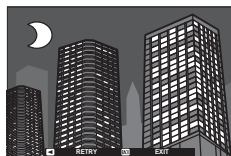
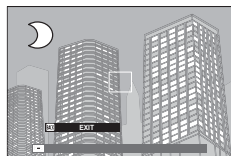

## Adv. ADVANCED FILTER

Take photos with filter effects.

- 1 Rotate the mode dial to **Adv.** (**ADVANCED FILTER**).

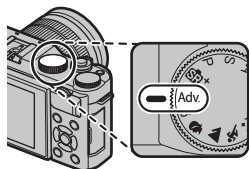



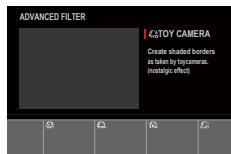













- 2 Press **MENU/OK** while the mode description is displayed.



If the view through the lens is displayed in the LCD monitor, press **MENU/OK** and select **ADVANCED FILTER** in the shooting menu.

- 3 Highlight one of the following options and press **MENU/OK**.

Filter	Description
 <b>TOY CAMERA</b>	Choose for a retro toy camera effect.
 <b>POP COLOR</b>	Create high-contrast images with saturated colors.
 <b>HIGH-KEY</b>	Create bright, low-contrast images.
 <b>LOW-KEY</b>	Create uniformly dark tones with few areas of emphasized highlights.
 <b>FISH-EYE</b>	Create a distorting effect of a fisheye lens.
 <b>DYNAMIC TONE</b>	Dynamic tone expression is used for a fantasy effect.
 <b>HDR ART</b>	Create artistic effect by emphasizing tone reproduction and dynamic range.
 <b>MINIATURE</b>	The tops and bottoms of pictures are blurred for a diorama effect.

Filter	Description
 <b>CROSS SCREEN</b>	Create a star pattern where lines radiate out from bright objects. The effects of the cross screen filter can be viewed after shooting.
 <b>PARTIAL COLOR (RED)</b>	Areas of the image that are the selected color are recorded in that color. All other areas of the image are recorded in black-and-white.
 <b>PARTIAL COLOR (ORANGE)</b>	
 <b>PARTIAL COLOR (YELLOW)</b>	
 <b>PARTIAL COLOR (GREEN)</b>	
 <b>PARTIAL COLOR (BLUE)</b>	
 <b>PARTIAL COLOR (PURPLE)</b>	
 <b>FOG REMOVE</b>	Create clearer image by removing fog factor.
 <b>SOFT FOCUS</b>	Create a look that is evenly soft throughout the whole image.

 Depending on the subject and camera settings, images may in some cases be grainy or vary in brightness or hue.

## Autofocus

Take pictures using autofocus.



- 1 Use **AF/MF SETTING > FOCUS MODE** to choose a focus mode (📖 65).
- 2 Use **AF/MF SETTING > AF MODE** to choose an AF mode (📖 67).
- 3 Choose the position and size of the focus frame (📖 69).

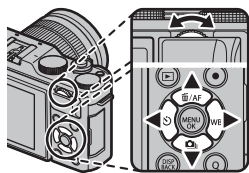

- 4 Take pictures.







For information on the autofocus system, visit:  
<http://fujifilm-x.com/af/en/index.html>





## Focus Mode

Use the **FOCUS MODE** option in the  **AF/MF SETTING** menu to choose how the camera focuses.

- 1 Press **MENU/OK** to display the menus.
- 2 Select  **AF/MF SETTING** > **FOCUS MODE** in the shooting menu.
- 3 Choose from the following options:

Mode	Description
 <b>MANUAL FOCUS</b>	Focus manually using the lens focus ring. Choose for manual control of focus or in situations in which the camera is unable to focus using autofocus (  73).
 <b>CONTINUOUS AF</b>	Focus is continually adjusted to reflect changes in the distance to the subject while the shutter button is pressed halfway. Use for subjects that are in motion. Eye-detection AF is not available.
 <b>SINGLE AF</b>	Focus locks while the shutter button is pressed halfway. Choose for stationary subjects.

 Regardless of the option selected, manual focus will be used when the lens is in manual focus mode.

If **ON** is selected for  **AF/MF SETTING** > **PRE-AF**, focus will be adjusted continuously in modes  and  even when the shutter button is not pressed.

## The Focus Indicator

The focus indicator turns green when the subject is in focus and blinks white when the camera is unable to focus. Brackets (“ [ ] ”) indicate that the camera is focusing and are displayed continuously in mode **MF-L**. **MF** is displayed in manual focus mode.



*Focus indicator*





## Autofocus Options (AF Mode)

Choose how the camera focuses in modes **[AF-S]** and **[AF-C]**.



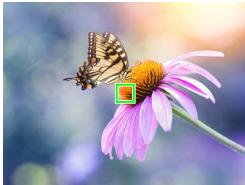

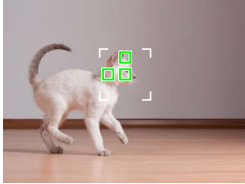
- 1 Press **MENU/OK** and go to the shooting menu.
- 2 Select **[AF] AF/MF SETTING > AF MODE**.
- 3 Choose an AF mode.

How the camera focuses depends on the focus mode.

### Focus Mode **[AF-S]** (SINGLE AF)

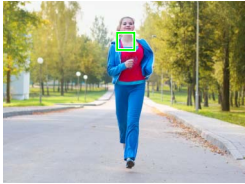
Option	Description	Sample image
 <b>SINGLE POINT</b>	Camera focuses on subject in selected focus point. Use for pin-point focus on selected subject.	
 <b>ZONE</b>	Camera focuses on subject in selected focus zone. Focus zones include multiple focus points, making it easier to focus on subjects in motion.	
 <b>WIDE/TRACKING</b>	Camera focuses automatically on high-contrast subjects; display shows areas in focus.	

## Focus Mode (CONTINUOUS AF)

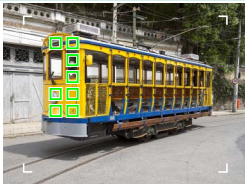
Option	Description	Sample image
 <b>SINGLE POINT</b>	Focus tracks subject at selected focus point. Use for subjects moving toward or away from camera.	
 <b>ZONE</b>	Focus tracks subject in selected focus zone. Use for subjects that are moving fairly predictably.	
 <b>WIDE/TRACKING</b>	Focus tracks subjects moving through wide area of frame.	

## Focus-Point Selection

Choose a focus point for autofocus.

### Viewing the Focus-Point Display

- 1 Press the selector up (AF) to view the focus-point display.

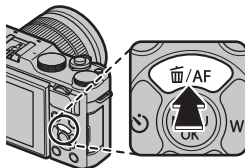

- 2 Use the selector and sub-command dial to position the focus frame over the desired focus point.

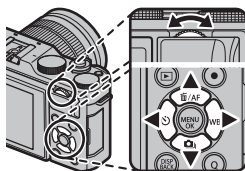







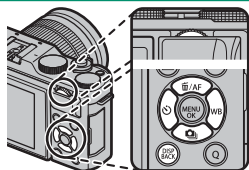



 Focus-area selection can also be accessed via the shooting menu.

## Selecting a Focus Point

Use the selector to choose the focus point and the sub-command dial to choose the size of the focus frame. The procedure varies with the option selected for AF mode.



	Selector	DISP/BACK button	Sub-command dial	
<b>AF mode</b>	 <b>Press</b>	 <b>Press</b>	 <b>Rotate</b>	 <b>Press</b>
	Select focus point	Select center focus point	Choose from 5 frame sizes	Restore original size
			Choose from 3 frame sizes	
			—	

 Manual focus-point selection is not available when  **WIDE/TRACKING** is selected in focus mode .

## The Focus-Point Display

The focus-point display varies with the option selected for AF mode.

Focus frames are shown by small squares (□), focus zones by the large squares.

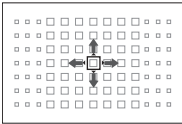
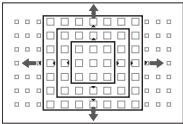
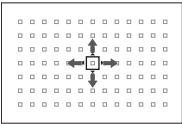
AF mode		
□ SINGLE POINT	[L] ZONE	[L] WIDE/TRACKING
		
Choose single focus point.	Choose from zones with 7 × 7, 5 × 5, or 3 × 3 focus points.	Position focus frame over subject and press <b>MENU/OK</b> .

### Available Focus Points

TTL contrast-detect AF offers more focus points (①) than intelligent hybrid AF (②), which combines phase-detection with TTL contrast-detect AF.

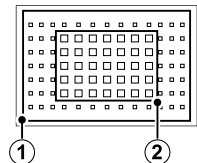

### Burst Mode Focus-Frame Selection

When continuous high-speed (H) is selected for drive mode, the number of focus frames available in focus mode **AF-C** drops.

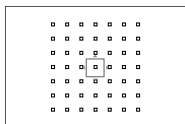

Single point

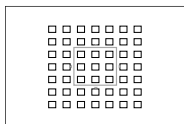

Zone

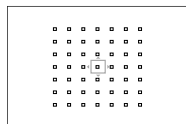

Tracking

## Autofocus

Although the camera boasts a high-precision autofocus system, it may be unable to focus on the subjects listed below.

- Very shiny subjects such as mirrors or car bodies.
- Subjects photographed through a window or other reflective object.
- Dark subjects and subjects that absorb rather than reflect light, such as hair or fur.
- Insubstantial subjects, such as smoke or flame.
- Subjects that show little contrast with the background.
- Subjects positioned in front of or behind a high-contrast object that is also in the focus frame (for example, a subject photographed against a backdrop of highly contrasting elements).

## Checking Focus

To zoom in on the current focus area for precise focus, press the center of the sub-command dial. Press again to cancel zoom.

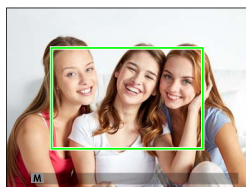
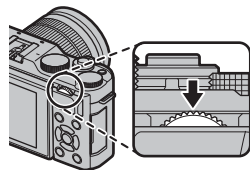

Normal display



Focus zoom



In focus mode **AF-S**, zoom can be adjusted by rotating the sub-command dial. Focus zoom is not available in focus mode **AF-C** or when **AF/MF SETTING > PRE-AF** is on or an option other than **SINGLE POINT** is selected for **AF MODE**.



## Manual Focus

Adjust focus manually.



- 1 Select **MANUAL FOCUS** for  **AF/MF SETTING > FOCUS MODE**.

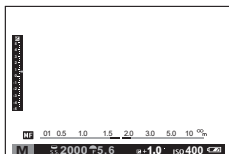

 will appear in the display.

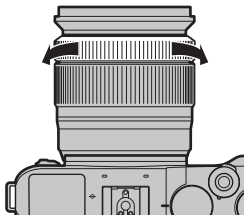

- 2 Focus manually using the lens focus ring. Rotate the ring left to reduce the focus distance, right to increase.



- 3 Take pictures.

 Use the  **FOCUS RING** option in the setup menu to reverse the direction of rotation of the focus ring.

Regardless of the option selected, manual focus will be used when the lens is in manual focus mode.

**INSTANT AF** can be assigned to the **Fn** button, allowing the button to be used to quickly focus on the subject in the selected focus frame when the camera is in manual focus mode.

## Checking Focus

A variety of options are available for checking focus in manual focus mode.

### The Manual Focus Indicator

The manual focus indicator indicates how closely the focus distance matches the distance to the subject in the focus brackets. The white line indicates the distance to the subject in the focus area (in meters or feet according to the option selected for  **SCREEN SET-UP > FOCUS SCALE UNITS** in the setup menu), the blue bar the depth of field, or in other words the distance in front of and behind the subject that appears to be in focus.

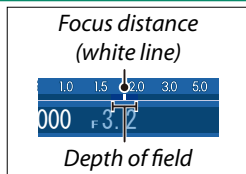

If both **AF DISTANCE INDICATOR** and **MF DISTANCE INDICATOR** are selected in the  **SCREEN SET-UP > DISP. CUSTOM SETTING** list, depth of field can also be previewed using the depth-of-field indicator in the standard display. Use the **DISP/BACK** button to display standard indicators.

### Focus Zoom

If **ON** is selected for  **SCREEN SET-UP > FOCUS CHECK**, the camera will automatically zoom in on the selected focus area when the focus ring is rotated. Zoom can be adjusted by rotating the sub-command dial. Press the center of the sub-command dial to exit zoom.

### Focus Peaking

Select **FOCUS PEAK HIGHLIGHT** for  **MF ASSIST** to highlight high-contrast outlines. When focusing, rotate the focus ring until the subject is highlighted.

The  **MF ASSIST** menu can be displayed by pressing and holding the center of the sub-command dial.

## Exposure Compensation

Adjust exposure.



Rotate the main command dial to adjust exposure.

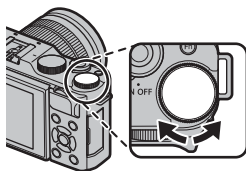

 The amount of compensation available varies with the shooting mode.

## Focus/Exposure Lock

Compose photographs with off-center subjects.



- 1 Focus:** Position the subject in the focus frame and press the shutter button halfway to lock focus and exposure. Focus and exposure will remain locked while the shutter button is pressed halfway (AF/AE lock).

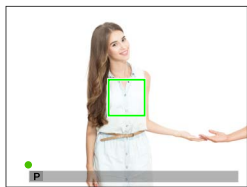

- 2 Recompose:** Keep the shutter button pressed halfway.

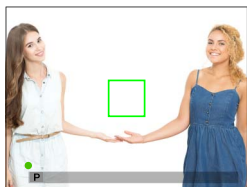

- 3 Shoot:** Press the button all the way down.

### The AF-L and AE-L Buttons

If **AE-LOCK**, **AF-LOCK**, or **AE/AF LOCK** is assigned to the **Fn** button, the focus and/or exposure will lock while the **Fn** button is pressed and remain locked even when the shutter button is pressed halfway.

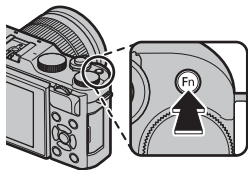

## WB White Balance

For natural colors, choose a white balance option that matches the light source.



- 1 Press the selector right (**WB**) to display white balance options.

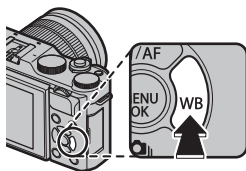



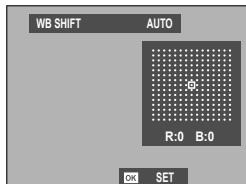





- 2 Highlight the desired option and either press **MENU/OK** to select the highlighted option and view a display where white balance can be fine-tuned using the selector, or press **DISP/BACK** to select the highlighted option with no fine tuning.





 White balance options can also be accessed from the shooting menu.

## WHITE BALANCE

The following white balance options are available.

Option	Description
<b>AUTO</b>	White balance is adjusted automatically.
	Measure a value for white balance.
<b>K</b>	Choose a color temperature.
	For subjects in direct sunlight.
	For subjects in the shade.
	Use under "daylight" fluorescent lights.
	Use under "warm white" fluorescent lights.
	Use under "cool white" fluorescent lights.
	Use under incandescent lighting.
	Reduces the blue cast typically associated with underwater lighting.

 Results vary with shooting conditions. Play pictures back after shooting to check colors.

White balance is adjusted for flash lighting only in **AUTO** and  modes. Turn the flash off using other white balance options.

## Custom White Balance

Choose  to adjust white balance for unusual lighting conditions. White balance measurement options will be displayed; frame a white object so that it fills the display and press the shutter button all the way down to measure white balance (to select the most recent custom value and exit without measuring white balance, press **DISP/BACK**, or press **MENU/OK** to select the most recent value and display the fine-tuning dialog).

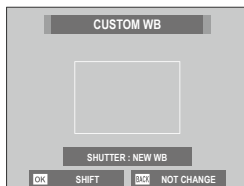

- If **“COMPLETED!”** is displayed, press **MENU/OK** to set white balance to the measured value.
- If **“UNDER”** is displayed, raise exposure compensation and try again.
- If **“OVER”** is displayed, lower exposure compensation and try again.

## **K**: Color Temperature

Selecting **K** in the white balance menu displays a list of color temperatures; highlight a color temperature and press **MENU/OK** to select the highlighted option and display the fine-tuning dialog.

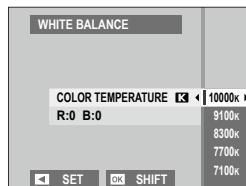

### Color Temperature

Color temperature is an objective measure of the color of a light source, expressed in Kelvin (K). Light sources with a color temperature close to that of direct sunlight appear white; light sources with a lower color temperature have a yellow or red cast, while those with a higher color temperature are tinged with blue. You can match color temperature to the light source, or choose options that differ sharply from the color of the light source to make pictures “warmer” or “colder.”





## Using the Self Timer

Use the timer for group- or self-portraits, to prevent blur caused by camera shake, or to release the shutter automatically when selected conditions are met.



- 1 Press the selector left (◀) to display self-timer options.

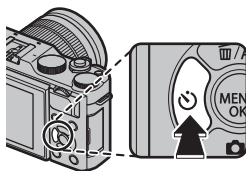

- 2 Highlight one of the following options and press **MENU/OK**.

Option		Option	
<b>2 SEC</b>	82	<b>BUDDY</b>	84
<b>10 SEC</b>	82	<b>GROUP</b>	84
<b>FACE AUTO SHUTTER</b>	83	<b>OFF</b>	—
<b>SMILE</b>	83		

Stand behind the camera when using the shutter button. Standing in front of the lens can interfere with focus and exposure.

The self-timer turns off automatically when the camera is turned off.

To stop the timer before the picture is taken, press **DISP/BACK**.



Selecting **FACE AUTO SHUTTER**, **SMILE**, **BUDDY**, or **GROUP** sets **AF/MF SETTING > FACE/EYE DETECTION SETTING** to **FACE ON/EYE OFF**. The original setting is restored when the self timer is turned off.

Self-timer options can also be selected in the shooting menu.

## 2 SEC/10 SEC

The shutter is released 2 or 10 seconds after the shutter button is pressed.

- 1 Highlight either of the following options in the self-timer menu and press **MENU/OK**.

Option	Description
 <b>2 SEC</b>	The shutter is released two seconds after the shutter button is pressed. Use to reduce blur caused by the camera moving when the shutter button is pressed. The self-timer lamp blinks as the timer counts down.
 <b>10 SEC</b>	The shutter is released ten seconds after the shutter button is pressed. Use for photographs in which you wish to appear yourself. The self-timer lamp blinks immediately before the picture is taken.

- 2 Press the shutter button all the way down to start the timer. A count-down timer will appear in the display; the picture will be taken when the timer expires.

## FACE AUTO SHUTTER

The picture will be taken when the camera detects a portrait subject facing the lens.

- 1 Highlight  (**FACE AUTO SHUTTER**) in the self-timer menu and press **MENU/OK**.
- 2 Frame a portrait subject in the display. The camera will initiate face detection and release the shutter when the subject is facing the lens.



 The camera may fail to detect subjects who are not facing the camera or whose eyes are hidden.

## SMILE

The camera releases the shutter when the subject smiles.

- 1 Highlight  (**SMILE**) in the self-timer menu and press **MENU/OK**.
- 2 Frame portrait subjects in the display. The camera will initiate face detection and release the shutter when any of the subjects smiles.





 The camera may fail to detect subjects who are not facing the camera or whose eyes are obscured by hair or other objects.

## BUDDY

The camera takes a picture when it detects two subjects close together.

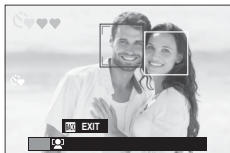

- 1 Highlight  (**BUDDY**) in the self-timer menu and press **MENU/OK**.
- 2 When prompted to choose how close the subjects must be together before the timer starts, highlight the desired option and press **MENU/OK** (the required degree of closeness is shown by heart icons in the shooting display: the more hearts, the closer together the subjects must be).
  - **LV.1 (NEAR)**: The timer starts when the subjects are close enough to link hands.
  - **LV.2 (CLOSE UP)**: The timer starts when the subjects are shoulder-to-shoulder.
  - **LV.3 (SUPER CLOSE)**: The timer starts when the subjects are cheek-to-cheek.



 The timer starts only when the subjects are sufficiently close together; the shutter is released one second later.

## GROUP

The camera takes a picture when it detects the selected number of portrait subjects.

- 1 Highlight  (**GROUP**) in the self-timer menu and press **MENU/OK**.
- 2 Highlight the desired number of subjects (1 to 4) and press **MENU/OK** (the number of subjects is indicated by  icons in the shooting display). The timer starts only when the selected number of subjects is in the frame; the shutter is released two seconds later.





## Bracketing

Automatically vary settings over a series of pictures.



- 1 Press the selector down () to display bracketing options.

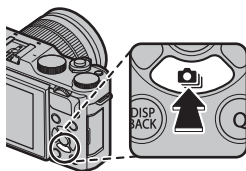

- 2 Press the selector up or down to highlight one of the following:

Option		Option	
AE BKT	86	WHITE BALANCE BKT	86
ISO BKT	86	DYNAMIC RANGE BKT	87
FILM SIMULATION BKT	86	HDR	87

- 3 Press the selector left or right to highlight the desired bracketing settings and press **MENU/OK** to select the highlighted option.

Bracketing settings for AE and film simulation bracketing are selected using the **AE BKT SETTING** and **FILM SIMULATION BKT** options in the shooting menu.

- 4 Take pictures.

## AE BKT

Use  **AE BKT SETTING** to choose the bracketing amount and number of shots. Each time the shutter button is pressed, the camera will take the specified number of shots: one using the metered value for exposure and the others over- or under-exposed by multiples of the selected bracketing amount.

 Regardless of the bracketing amount, exposure will not exceed the limits of the exposure metering system.

## ISO BKT

Select a bracketing amount ( $\pm 1$ ,  $\pm \frac{2}{3}$ , or  $\pm \frac{1}{3}$ ). Each time the shutter is released, the camera will take a picture at the current sensitivity and process it to create two additional copies, one with sensitivity raised and the other with sensitivity lowered by the selected amount.

## FILM SIMULATION BKT

Each time the shutter is released, the camera takes one shot and processes it to create a total of three copies with different film simulation settings, chosen using the  **FILM SIMULATION BKT** option in the shooting menu.

## WHITE BALANCE BKT

Select a bracketing amount ( $\pm 1$ ,  $\pm 2$ , or  $\pm 3$ ). Each time the shutter is released, the camera takes one shot and processes it to create three copies: one at the current white balanced setting, one with fine-tuning increased by the selected amount, and another with fine-tuning decreased by the selected amount.

## DYNAMIC RANGE BKT

Each time the shutter button is pressed, the camera takes three shots with different dynamic ranges: 100% for the first, 200% for the second, and 400% for the third.

 While dynamic range bracketing is in effect, sensitivity will be restricted to a minimum of ISO 800 (or to a minimum of ISO 200 to 800 when an auto option is selected for sensitivity); the sensitivity previously in effect is restored when bracketing ends.

## HDR

Each time the shutter button is pressed, the camera takes multiple shots at different exposures and combines them into a single high-dynamic-range image, reducing loss of detail in highlights and shadows. Choose the amount the camera varies exposure from **AUTO**, **1.0 EV**, **1.5 EV**, **2.0 EV**, **2.5 EV**, and **3.0 EV**.

 Keep the camera steady. If the camera is moved or the subject changes during shooting, the shots may be recorded separately instead of being combined into a single image. The camera may fail to record an image if the subject moves during shooting.

 The camera displays the combined image after shooting. Press **MENU/OK** to save the image or **DISP/BACK** to end HDR shooting without recording the image.









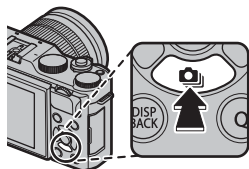

## Continuous Shooting (Burst Mode)

Capture motion in a series of pictures.



- 1 Press the selector down () to display continuous shooting options.



- 2 Press the selector up or down to highlight  **CONTINUOUS** ( 89) or  **4K** ( 90).
- 3 Press the selector left or right to highlight the desired option and press **MENU/OK** to select. The frame rate for continuous shooting can be selected from  **HIGH** or  **LOW** and the shooting mode for 4K recording from  **4K BURST** or  **MULTI FOCUS MODE**.
- 4 Take pictures.



## CONTINUOUS

The camera takes pictures at the selected frame rate ( **HIGH** or  **LOW**) while the shutter button is pressed. Shooting ends when the shutter button is released or the memory card is full.





 If file numbering reaches 999 before shooting is complete, the remaining pictures will be recorded to a new folder.

Burst shooting may not begin if the space available on the memory card is insufficient.

Frame rate varies with the subject, shutter speed, sensitivity, and focus mode. Frame rates may slow and recording times increase as more shots are taken. The flash cannot be used.

## 4K

Shoot a burst of 4K pictures and choose which shots to save.

With  **4K** highlighted in the drive mode menu, press the selector left or right to highlight  **4K BURST** or  **MULTI FOCUS MODE**.

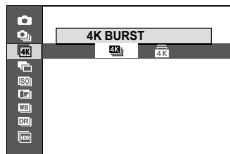



 Use a memory card with a UHS speed class of 3 or better.

## 4K BURST

Choose the frames you wish to save from a thumbnail list.



- 1 Shoot a burst of pictures with  **4K** >  **4K BURST** selected for drive mode.



The function performed by the shutter button can be selected using the  **RELEASE TYPE** option in the shooting menu.

- 2 In full-frame playback, display a picture taken with  **4K BURST**. Press the selector down to view the pictures in the burst as a thumbnail list.



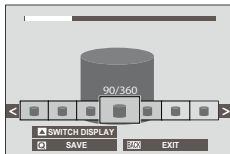

- 3 Press the selector left or right to highlight frames and press **Q** to save the highlighted frame as a separate image.



- 4 After saving the desired frames, press **DISP/BACK** to exit the thumbnail list.

 If the subject moves during shooting, the image may be distorted, while banding may occur in images taken under flickering or transient light sources such as fluorescent lights.

 To prevent motion blur, choose mode **S** or **M** and select a fast shutter speed.



If **CONTINUOUS** is selected for  **SCREEN SET-UP > IMAGE DISP.**, the most recent picture will be displayed when shooting ends, allowing you to select the frames to be saved without exiting to playback mode.

The flash cannot be used.

## MULTI FOCUS MODE

Take a series of pictures at different focus distance and create a composite image from selected shots.



- 1 Shoot a burst of pictures with  4K >  MULTI FOCUS MODE selected for drive mode.



The camera will shoot a burst of pictures each time the shutter button is pressed. There is no need to keep the shutter button pressed during shooting.

- 2 In full-frame playback, display a picture taken with  MULTI FOCUS MODE.



- 3 Press the selector down and choose the shots that will be used to create a composite image.

Option	Description
<b>SELECT FOCUS</b>	The area in focus in any given frame is indicated by a square (□). Highlight a focus point using the selector and press <b>Q</b> to create a composite image from the frames for which the selected area is in focus.
<b>AUTO</b>	The camera creates a composite image from the areas that are in focus.
<b>SELECT RANGE</b>	Create a composite image from the frames in which a selected area is in focus.

 A tripod is recommended; if no tripod is available, hold the camera steady during shooting. If the subject moves during shooting, the image may be distorted or unnatural, while banding may occur in images taken under flickering or transient light sources such as fluorescent lights. The process of creating a composite image reduces the angle of view. The desired results may not be achieved with moving subjects, distant landscapes, or subjects that lack depth. When shooting with macro lenses, note that the camera may require some time to create a composite image, and that the desired results may not be achieved if the subject is at some distance from the background.

 If **CONTINUOUS** is selected for  **SCREEN SET-UP > IMAGE DISP.**, the most recent picture will be displayed when shooting ends, allowing you to create a composite image without exiting to playback mode.

The flash cannot be used.

## Using the Flash

Use the built-in flash for additional lighting when shooting at night or indoors under low light.



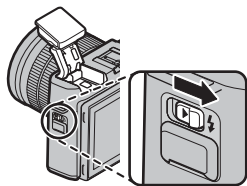

- 1 Slide the ⚡ (flash pop-up) switch to raise the flash.



- 2 Press **MENU/OK** to display the shooting menu.
- 3 Highlight **FLASH SET-UP > FLASH MODE** in the shooting menu and press **MENU/OK** to view flash options.
- 4 Highlight one of the following options and press **MENU/OK**.



Mode	Description
<b>AUTO AUTO FLASH</b> <b>RED EYE REDUCTION*</b>	The flash fires when required. Recommended in most situations.
<b>FORCED FLASH</b> <b>FORCED FLASH*</b>	The flash fires whenever a picture is taken. Use for backlit subjects or for natural coloration when shooting in bright light.
<b>SLOW SYNCHRO</b> <b>RED EYE &amp; SLOW*</b>	Capture both the main subject and the background under low light (note that brightly lit scenes may be overexposed).
<b>2ND CURTAIN SYNC.</b> <b>2ND CURTAIN SYNC.*</b>	The flash fires immediately before the shutter closes.

Mode	Description
 <b>COMMANDER</b>	The built-in flash can be used to control optional remote flash units.
 <b>SUPPRESSED FLASH</b>	The flash does not fire even when the subject is poorly lit. A tripod is recommended.

\* Red-eye removal is available in these modes when Intelligent Face Detection is active and red-eye removal is on. Red-eye removal minimizes “red-eye” caused when light from the flash is reflected from the subject’s retinas as shown in the illustration at right.

 Depending on the distance to the subject, some lenses may cast shadows in photos taken with the flash.

The flash may contact accessories mounted on the hot shoe. If necessary, remove accessories before raising the flash.

 If  is displayed when the shutter button is pressed halfway, the flash will fire when the photo is taken.

Except in commander mode, the flash may fire several times with each shot. Do not move the camera until shooting is complete.

#### Flash Sync Speed

The flash will synchronize with the shutter at shutter speeds of  $\frac{1}{80}$  s or slower.

#### Optional Flash Units from FUJIFILM

The camera can be used with optional FUJIFILM shoe-mounted flash units.

#### Third-Party Flash Units

Do not use third-party flash units that apply over 300 V to the camera hot shoe.

## Self-Portraits (Selfies)

To shoot a self-portrait, rotate the LCD monitor as shown.

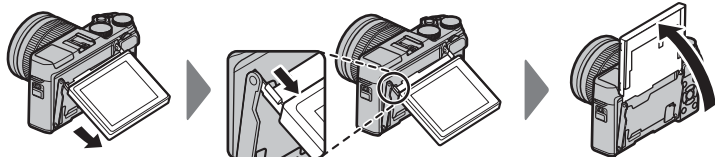

Rotating the LCD monitor 180° automatically sets **AF/MF SETTING > FACE/EYE DETECTION SETTING** to **FACE ON/EYE AUTO**. If **ON** is selected for **ELECTRONIC ZOOM SETTING** and a power zoom lens is attached, you can rotate the sub-command dial to adjust zoom. You can also release the shutter by pressing the center of the command dial. Regardless of the option selected for **SCREEN SET-UP > IMAGE DISP.**, pictures will be displayed for 1.5 seconds after shooting.

### The Self-Portrait Display

When rotated to the self-portrait position, the LCD monitor shows a mirror image of the view through the lens.

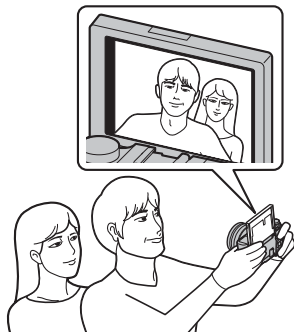







# 6

## **The Shooting Menus**

## SHOOTING MENU ( / / / / )

Adjust shooting settings.

The shooting menu is displayed when you press **MENU/OK** in shooting mode. Choose from tabs , , , , or .

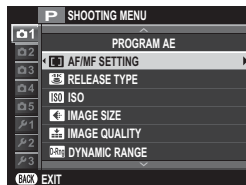

 The options available vary with the shooting mode selected.

### SCENE POSITION

Choose a scene for **SP** mode (  59).

### ADVANCED FILTER

Choose an advanced filter for **Adv.** mode (  62).

### AF/MF SETTING

Adjust focus settings.



#### **FOCUS AREA**

Choose the focus area for autofocus, manual focus, and focus zoom (  69).

#### **FOCUS MODE**

Choose how the camera focuses (  65).

#### **AF MODE**

Choose the AF mode for focus modes  and  (  67).



**RELEASE/FOCUS PRIORITY**

Choose how the camera focuses in focus mode **AF-S** (AF-S) or **AF-C** (AF-C).

Option	Description
<b>RELEASE</b>	Shutter response is prioritized over focus. Pictures can be taken when the camera is not in focus.
<b>FOCUS</b>	Focus is prioritized over shutter response. Pictures can be only taken when the camera is in focus.

**AF+MF**

If **ON** is selected in focus mode AF-S, focus can be adjusted manually by rotating the focus ring while the shutter button is pressed halfway.

Options	
ON	OFF
 Lenses with a focus distance indicator must be set to manual focus mode (MF) before this option can be used. Selecting MF disables the focus distance indicator. Set the focus ring to the center of the focus distance indicator, as the camera may fail to focus if the ring is set to infinity or the minimum focus distance.	
 Focus peaking can be used to check focus. To enable focus peaking, select <b>FOCUS PEAK HIGHLIGHT</b> for MF ASSIST.	

**AF+MF Focus Zoom**

When **ON** is selected for  **SCREEN SET-UP > FOCUS CHECK** and **SINGLE POINT** selected for **AF MODE**, focus zoom can be used to zoom in on the selected focus area.

## FACE/EYE DETECTION SETTING

Intelligent Face Detection sets focus and exposure for human faces anywhere in the frame, preventing the camera from focusing on the background in group portraits. Choose for shots that emphasize portrait subjects. Faces can be detected with the camera in vertical or horizontal orientation; if a face is detected, it will be indicated by a green border. If there is more than one face in the frame, the camera will select the face closest to the center; other faces are indicated by white borders. You can also choose whether the camera detects and focuses on eyes when Intelligent Face Detection is on. Choose from the following options:

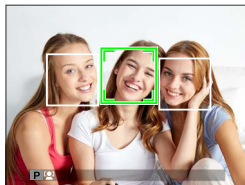

Option	Description
<b>FACE ON/EYE OFF</b>	Intelligent Face Detection only.
<b>FACE ON/EYE AUTO</b>	The camera automatically chooses which eye to focus on when a face is detected.
<b>FACE ON/RIGHT EYE PRIORITY</b>	The camera focuses on the right eye of subjects detected using Intelligent Face Detection.
<b>FACE ON/LEFT EYE PRIORITY</b>	The camera focuses on the left eye of subjects detected using Intelligent Face Detection.
<b>FACE OFF/EYE OFF</b>	Intelligent Face Detection and eye priority off.

 In some modes, the camera may set exposure for the frame as a whole rather than the portrait subject.

If the subject moves as the shutter button is pressed, the face may not be in the area indicated by the green border when the picture is taken.

 If the camera is unable to detect the subject's eyes because they are hidden by hair, glasses, or other objects, the camera will instead focus on faces.

**PRE-AF**



If **ON** is selected, the camera will continue to adjust focus even when the shutter button is not pressed halfway. Note that this increases the drain on the battery.

Options	
<b>ON</b>	<b>OFF</b>

**AF ILLUMINATOR**

If **ON** is selected, the AF-assist illuminator will light to assist autofocus.



Options	
<b>ON</b>	<b>OFF</b>

 The AF-assist illuminator turns off automatically when **OFF** is selected for  **SOUND & FLASH** in the setup menu.

The camera may be unable to focus using the AF-assist illuminator in some cases. If the camera is unable to focus, try increasing the distance to the subject.

Avoid shining the AF-assist illuminator directly into your subject's eyes.

 **RELEASE TYPE**

Choose how the shutter button functions when  **4K** >  **4K BURST** is selected as the drive mode.

Option	Description
<b>WHEN PRESSING</b>	Pictures are taken while the shutter button is pressed.
<b>ON/OFF SWITCH</b>	Shooting starts when the shutter button is pressed and ends when the button is pressed a second time.
<b>PRE RECORD</b>	The camera starts saving frames to a memory buffer when the shutter button is pressed halfway. When the shutter button is pressed the rest of the way down, the camera transfers the frames shot in the previous second to the memory card and continues shooting until the shutter button is released.

Adjust the camera's sensitivity to light.

Option	Description
<b>AUTO1</b>	Sensitivity is automatically adjusted in response to shooting conditions. Choose the base sensitivity, maximum sensitivity, and minimum shutter speed for <b>AUTO1</b> , <b>AUTO2</b> , and <b>AUTO3</b> .
<b>AUTO2</b>	
<b>AUTO3</b>	
<b>12800–200</b>	Adjust sensitivity manually. Selected value is shown in display.
<b>H</b> (25600/51200), <b>L</b> (100)	Choose for special situations. Note that mottling may appear in pictures taken at <b>H</b> , while <b>L</b> reduces dynamic range.



Sensitivity is not reset when the camera is turned off.

If a **RAW** option is selected for image quality, pictures taken with **L** selected for **ISO ISO** will be recorded at ISO 200, while those taken with **H** selected will be recorded at ISO 12800.

### Adjusting Sensitivity

High values can be used to reduce blur when lighting is poor, while lower values allow slower shutter speeds or wider apertures in bright light; note, however, that mottling may appear in pictures taken at high sensitivities.

### AUTO

Choose the base sensitivity, maximum sensitivity, and minimum shutter speed for **AUTO1**, **AUTO2**, and **AUTO3**. Defaults are shown below.

Item	Options	Default		
		AUTO1	AUTO2	AUTO3
<b>DEFAULT SENSITIVITY</b>	6400–200	200		
<b>MAX. SENSITIVITY</b>	6400–400	800	1600	3200
<b>MIN. SHUTTER SPEED</b>	$\frac{1}{500}$ – $\frac{1}{4}$ SEC, AUTO	AUTO		

The camera automatically chooses a sensitivity between the default and maximum values; sensitivity is only raised above the default value if the shutter speed required for optimal exposure would be slower than the value selected for **MIN. SHUTTER SPEED**.

 If the value selected for **DEFAULT SENSITIVITY** is higher than that selected for **MAX. SENSITIVITY**, **DEFAULT SENSITIVITY** will be set to the value selected for **MAX. SENSITIVITY**.

The camera may select shutter speeds slower than **MIN. SHUTTER SPEED** if pictures would still be underexposed at the value selected for **MAX. SENSITIVITY**. If **AUTO** is selected for **MIN. SHUTTER SPEED**, the camera will automatically choose a minimum shutter speed approximately equal to the inverse of the lens' focal length, in seconds (for example, if the lens has a focal length of 50 mm, the camera will choose a minimum shutter speed in the neighborhood of  $\frac{1}{50}$  s). The minimum shutter speed is not affected by the option selected for image stabilization.

## IMAGE SIZE

Choose the size and aspect ratio at which still pictures are recorded.

Option	Image size	Option	Image size	Option	Image size
<b>L</b> 3:2	6000 × 4000	<b>L</b> 16:9	6000 × 3376	<b>L</b> 1:1	4000 × 4000
<b>M</b> 3:2	4240 × 2832	<b>M</b> 16:9	4240 × 2384	<b>M</b> 1:1	2832 × 2832
<b>S</b> 3:2	3008 × 2000	<b>S</b> 16:9	3008 × 1688	<b>S</b> 1:1	2000 × 2000

 **IMAGE SIZE** is not reset when the camera is turned off or another shooting mode is selected.

### Aspect Ratio

Pictures with an aspect ratio of 3:2 have the same proportions as a frame of 35 mm film, while an aspect ratio of 16:9 is suited to display on High Definition (HD) devices. Pictures with an aspect ratio of 1:1 are square.

## IMAGE QUALITY

Choose a file format and compression ratio. Select **FINE** or **NORMAL** to record JPEG images, **RAW** to record RAW images, or **FINE+RAW** or **NORMAL+RAW** to record both JPEG and RAW images. **FINE** and **FINE+RAW** use lower JPEG compression ratios for higher-quality JPEG images, while **NORMAL** and **NORMAL+RAW** use higher JPEG compression ratios to increase the number of images that can be stored.

### The Fn Button

To toggle RAW image quality on or off for a single shot, assign **RAW** to the **Fn** button ( 162). If a JPEG option is currently selected for image quality, pressing the **Fn** button temporarily selects the equivalent JPEG+RAW option. If a JPEG+RAW option is currently selected, pressing the **Fn** button temporarily selects the equivalent JPEG option, while if **RAW** is selected, pressing the **Fn** button temporarily selects **FINE**. Taking a picture or pressing the **Fn** button again restores the previous setting.



**D-Rng DYNAMIC RANGE**

Control contrast. Choose lower values to increase contrast when shooting indoors or under overcast skies, higher values to reduce loss of detail in highlights and shadows when photographing high-contrast scenes. Higher values are recommended for scenes that include both sunlight and deep shade, for such high-contrast subjects as sunlight on water, brightly-lit autumn leaves, and portraits taken against a blue sky, and for white objects or people wearing white; note, however, that mottling may appear in pictures taken at higher values.













Options			
<b>AUTO</b>	<b>☺100 100%</b>	<b>☺200 200%</b>	<b>☺400 400%</b>

 If **AUTO** is selected, the camera will automatically choose either **☺100 100%** or **☺200 200%** according to the subject and shooting conditions. Shutter speed and aperture will be displayed when the shutter button is pressed halfway.

**☺200 200%** is available at sensitivities of ISO 400 and above, **☺400 400%** at sensitivities of ISO 800 and above.

## FILM SIMULATION

Simulate the effects of different kinds of film, including black-and-white (with or without color filters). Choose a palette according to your subject and creative intent.











Option	Description
 <b>PROVIA/STANDARD</b>	Standard color reproduction. Suited to a wide range of subjects, from portraits to landscapes.
 <b>Velvia/VIVID</b>	A high-contrast palette of saturated colors, suited to nature photos.
 <b>ASTIA/SOFT</b>	Enhances the range of hues available for skin tones in portraits while preserving the bright blues of daylight skies. Recommended for outdoor portrait photography.
 <b>CLASSIC CHROME</b>	Soft color and enhanced shadow contrast for a calm look.
 <b>PRO Neg. Hi</b>	Offers slightly more contrast than  ( <b>PRO Neg. Std</b> ). Recommended for outdoor portrait photography.
 <b>PRO Neg. Std</b>	A soft-toned palette. The range of hues available for skin tones is enhanced, making this a good choice for studio portrait photography.
 <b>MONOCHROME</b>	Take pictures in standard black and white.
 <b>MONOCHROME + Ye FILTER</b>	Take black-and-white pictures with slightly increased contrast. This setting also slightly tones down the brightness of the sky.
 <b>MONOCHROME + R FILTER</b>	Take black-and-white pictures with increased contrast. This setting also tones down the brightness of the sky.
 <b>MONOCHROME + G FILTER</b>	Soften skin tones in black-and-white portraits.
 <b>SEPIA</b>	Take pictures in sepia.

 Film simulation options can be combined with tone and sharpness settings.

For more information, visit: <http://fujifilm-x.com/en/x-stories/the-world-of-film-simulation-episode-1/>

## FILM SIMULATION BKT

Choose the three film simulation types used for film simulation bracketing ( 86, 106).

Options		
 <b>PROVIA/STANDARD</b>	 <b>Velvia/VIVID</b>	 <b>ASTIA/SOFT</b>
 <b>CLASSIC CHROME</b>	 <b>PRO Neg. Hi</b>	 <b>PRO Neg. Std</b>
 <b>MONOCHROME</b>	 <b>MONOCHROME + Ye FILTER</b>	 <b>MONOCHROME + R FILTER</b>
 <b>MONOCHROME + G FILTER</b>		 <b>SEPIA</b>

## SELF-TIMER

Use the timer for group- or self-portraits, to prevent blur caused by camera shake, or to release the shutter automatically when selected conditions are met ( 81).

## INTERVAL TIMER SHOOTING

Configure the camera to take photos automatically at a preset interval. If desired, frames shot using interval timer shooting can be joined to form a time-lapse movie.

- 1 Highlight  **INTERVAL TIMER SHOOTING** in the shooting menu and press **MENU/OK**.
- 2 Use the selector to choose the interval and number of shots. Press **MENU/OK** to proceed.

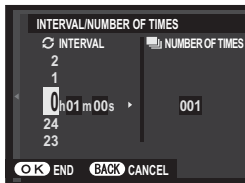

- 3 Highlight one of the following recording types and press **MENU/OK**.
  - **STILL**: Each photo is recorded separately.
  - **STILL + TIME-LAPSE MOVIE**: Each photo is recorded separately; in addition, the entire sequence is recorded as a time-lapse movie.



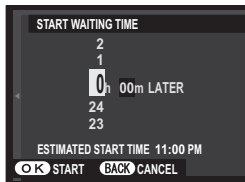

 The frame size and rate for the time-lapse movie can be selected using  **TIME-LAPSE MOVIE MODE** before shooting begins.

- 4 Use the selector to choose the starting time and then press **MENU/OK**.

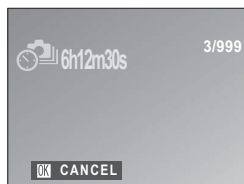

## 5 Shooting will start automatically.



 Interval timer photography cannot be used at a shutter speed of **B** (bulb) or HDR,  (4K), or during panorama or multiple exposure photography. In burst mode, only one picture will be taken each time the shutter is released.











 Use of a tripod is recommended.

Check the battery level before starting. We recommend using an optional AC-9V AC power adapter and CP-W126 DC coupler.

The display sometimes turns off between shots and lights a few seconds before the next shot is taken. The display can be activated at any time by pressing the shutter button.

## TIME-LAPSE MOVIE MODE

Choose the frame size and rate for time-lapse movies.

Option	Frame size	Rate
 <b>2160/30P</b> <sup>1</sup>	3840 × 2160 (4K)	30 fps
 <b>2160/15P</b> <sup>1</sup>		15 fps
 <b>1080/59.94P</b>	1920 × 1080 (Full HD)	59.94 fps
 <b>1080/50P</b>		50 fps
 <b>1080/24P</b>		24 fps
 <b>1080/23.98P</b>		23.98 fps
 <b>720/59.94P</b>		1280 × 720 (HD)
 <b>720/50P</b>	50 fps	
 <b>720/24P</b>	24 fps	
 <b>720/23.98P</b>	23.98 fps	

<sup>1</sup>Use a memory card with a UHS speed class of 3 or better when recording time-lapse movies that will be viewed on the camera.

## WB WHITE BALANCE

For natural colors, choose a white balance option that matches the light source (📖 77).

## Color COLOR

Adjust color density. Choose from 5 options between +2 and -2.

Options				
+2	+1	0	-1	-2

## Sharp SHARPNESS

Sharpen or soften outlines. Choose from 5 options between +2 and -2.

Options				
+2	+1	0	-1	-2

## HL Tone HIGHLIGHT TONE

Adjust the appearance of highlights. Choose from 5 options between +2 and -2.

Options				
+2	+1	0	-1	-2

**SHADOW TONE**

Adjust the appearance of shadows. Choose from 5 options between +2 and -2.

Options				
+2	+1	0	-1	-2

**NR NOISE REDUCTION**

Reduce noise in pictures taken at high sensitivities. Choose from 5 options between +2 and -2.

Options				
+2	+1	0	-1	-2

**LONG EXPOSURE NR**

Select **ON** to reduce mottling in long time-exposures.

Options	
<b>ON</b>	<b>OFF</b>

## AE BKT SETTING

Adjust exposure bracketing settings ( 86).

### **FRAMES/STEP SETTING**

Choose the number of shots in the bracketing sequence (**FRAMES**) and the amount exposure is varied with each shot (**STEP**).

#### **1 FRAME/CONTINUOUS**

Choose whether the shots in the bracketing sequence are taken one at a time (**1 FRAME**) or in a single burst (**CONTINUOUS**).

### **SEQUENCE SETTING**

Choose the order in which the shots are taken.

Option	Description
0 → + → -	The first shot is taken at current exposure settings and exposure compensation is then modified over the succeeding shots, proceeding in order from the highest to the lowest value.
0 → - → +	The first shot is taken at current exposure settings and exposure compensation is then modified over the succeeding shots, proceeding in order from the lowest to the highest value.
- → 0 → +	Shooting proceeds in order from the lowest to the highest value.
+ → 0 → -	Shooting proceeds in order from the highest to the lowest value.

## TOUCH SCREEN MODE

Choose whether touch controls can be used to select the focus area or release the shutter ( 14).

## TOUCH ZOOM

Enable touch digital zoom ( 17).



## LENS MOUNT ADAPTOR SETTING

Adjust settings for M-mount lenses connected using an optional FUJIFILM M MOUNT ADAPTER.

### Choosing a Focal Length

If the lens has a focal length of 21, 24, 28, or 35 mm, choose a matching option in the **LENS MOUNT ADAPTOR SETTING** menu.

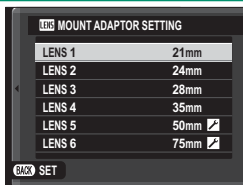

For other lenses, select option 5 or 6 to display the menu at right, press the selector right to display focal length settings, and use the selector to enter the focal length.

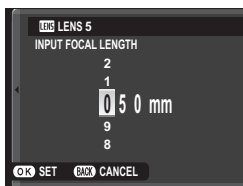

### Distortion Correction

Choose from **STRONG**, **MEDIUM**, or **WEAK** options to correct **BARREL** or **PINCUSHION** distortion.

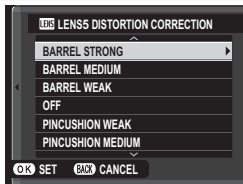

## Color Shading Correction

Color (shading) variations between the center and edges of the frame can be adjusted separately for each corner.

To use color shading correction, follow the steps below.

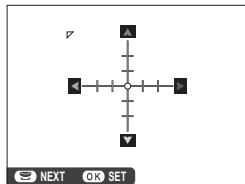



- 1 Rotate the sub-command dial to choose a corner. The selected corner is indicated by a triangle.
- 2 Use the selector to adjust shading until there is no visible difference in color between the selected corner and the center of the image. Press the selector left or right to adjust colors on the cyan–red axis. Press the selector up or down to adjust colors on the blue–yellow axis.

 To determine the amount required, adjust color shading correction while taking photos of blue sky or a sheet of gray paper.

## Peripheral Illumination Correction

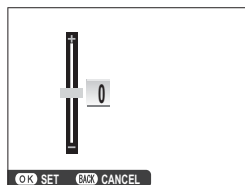
Choose from values between  $-5$  and  $+5$ . Choosing positive values increases peripheral illumination, while choosing negative values reduces peripheral illumination. Positive values are recommended for vintage lenses, negative values to create the effect of images taken with an antique lens or a pinhole camera.



 To determine the amount required, adjust peripheral illumination correction while taking photos of blue sky or a sheet of gray paper.

## SHOOT WITHOUT LENS

Choose **ON** to enable the shutter release when no lens is attached.

Options	
<b>ON</b>	<b>OFF</b>

## MF ASSIST



Choose how focus is displayed in manual focus mode.

Option	Description
<b>STANDARD</b>	Focus is displayed normally.
<b>FOCUS PEAK HIGHLIGHT</b>	The camera heightens high-contrast outlines. Choose a color and peaking level.



## PHOTOMETRY

Choose how the camera meters exposure.

 The selected option will only take effect when **AF/MF SETTING** > **FACE/EYE DETECTION SETTING** is **OFF**.

Mode	Description
 <b>MULTI</b>	The camera instantly determines exposure based on an analysis of composition, color, and brightness distribution. Recommended in most situations.
 <b>SPOT</b>	The camera meters lighting conditions in an area at the center of the frame equivalent to 2% of the total. Recommended with backlit subjects and in other cases in which the background is much brighter or darker than the main subject.
 <b>AVERAGE</b>	Exposure is set to the average for the entire frame. Provides consistent exposure across multiple shots with the same lighting, and is particularly effective for landscapes and portraits of subjects dressed in black or white.

## INTERLOCK SPOT AE & FOCUS AREA

Select **ON** to meter the current focus frame when **SINGLE POINT** is selected for  **AF/MF SETTING** > **AF MODE** and **SPOT** is selected for  **PHOTOMETRY**.

Options	
ON	OFF

## FLASH SET-UP

Adjust flash settings.

### **FLASH MODE**

Choose a flash mode ( 94).

### **FLASH COMPENSATION**

Adjust flash brightness. Choose from values between +2 EV and -2 EV. Note that the desired results may not be achieved depending on shooting conditions and the distance to the subject.

Options												
+2	+1 2/3	+1 1/3	+1	+2/3	+1/3	±0	-1/3	-2/3	-1	-1 1/3	-1 2/3	-2

### **RED EYE REMOVAL**

Choose **ON** to remove red-eye effects caused by the flash.

Options	
ON	OFF

 Red-eye reduction is performed only when a face is detected.

Red-eye removal is not available with RAW images.

## MOVIE SET-UP

Adjust movie-recording options.

### MOVIE MODE

Choose a frame size and rate for movie recording.

Option	Frame size	Rate
<b>4K</b> 2160/15P <sup>1</sup>	3840 × 2160 (4K)	15 fps
<b>Full HD</b> 1080/59.94P	1920 × 1080 (Full HD)	59.94 fps
<b>Full HD</b> 1080/50P		50 fps
<b>Full HD</b> 1080/24P		24 fps
<b>Full HD</b> 1080/23.98P		23.98 fps
<b>HD</b> 720/59.94P	1280 × 720 (HD)	59.94 fps
<b>HD</b> 720/50P		50 fps
<b>HD</b> 720/24P		24 fps
<b>HD</b> 720/23.98P		23.98 fps

<sup>1</sup> Use a memory card with a UHS speed class of 3 or better when recording time-lapse movies that will be viewed on the camera.

### HD HIGH SPEED VIDEO

Record high-frame-rate HD movies that play back in slow motion, giving you time to view fast-moving subjects or details too fleeting for the naked eye: a batter's swing, darting insects, or swiftly-flowing waters.

Option	Description
1.6×  59.94P  100P	Record HD (1280 × 720) movies at 1.6×, 2×, 3.3×, or 4× speed and a frame rate of 100 fps. The movies play back at 1/16, 1/2, 1/33, or 1/4 speed, respectively.
2×  50P  100P	
3.3×  29.97P  100P	
4×  25P  100P	
OFF	High-speed recording off.

 High-speed movies are recorded at a reduced frame size with no sound. Focus, exposure, zoom, and white balance are fixed at the values in effect at the start of recording. Movies shot under low light may be underexposed due to the high recording speeds; we recommend shooting outdoors in daylight or in other brightly-lit locations. If desired, high-speed movies can also be viewed in slow-motion on a computer.

## **MOVIE ISO**

Choose the sensitivity for movie recording from **AUTO** or from settings between ISO 400 and 6400.

 This setting has no effect on photographs.

## **FOCUS MODE**

Choose the focus mode for movie recording.

Option	Description
<b>MANUAL FOCUS</b>	Focus manually.
<b>CONTINUOUS AF</b>	The camera focuses using AF-C.
<b>SINGLE AF</b>	The camera focuses using AF-S.

## **AF MODE**

Choose how the camera selects the focus point for movie recording.

Option	Description
<b>MULTI</b>	Automatic focus-point selection.
<b>AREA</b>	The camera focuses on the subject in the selected focus area.

## **HDMI OUTPUT INFO DISPLAY**

If **ON** is selected, HDMI devices to which the camera is connected will mirror the information in the camera display.

Options	
<b>ON</b>	<b>OFF</b>

**4K MOVIE OUTPUT**

Choose the destination for 4K movies shot while the camera is connected to an HDMI recorder or other device that supports 4K.

Option	Description
 <b>SD CARD</b>	4K movies are recorded to a camera memory card and output to the HDMI device in 4K.
<b>HDMI</b>	4K movies are output to the HDMI device in 4K. The camera does not record 4K movies to a memory card.

**HDMI REC CONTROL**

Choose whether the camera sends movie start and stop signals to the HDMI device when the  (movie recording) button is pressed to start and stop movie recording.

Options	
<b>ON</b>	<b>OFF</b>



**MIC LEVEL ADJUSTMENT**

Adjust the recording level for the built-in and external microphones.

Options			
<b>4</b>	<b>3</b>	<b>2</b>	<b>1</b>





**MIC/REMOTE RELEASE**

Specify whether the device connected to the microphone/remote release connector is a microphone or a remote release.

Options	
 <b>MIC</b>	 <b>REMOTE</b>

## IS MODE

Choose from the following image stabilization options:

Option	Description
 <b>CONTINUOUS +MOTION</b>	Image stabilization on. If <b>+MOTION</b> is selected, the camera will adjust shutter speed to reduce motion blur when a moving objects are detected.
 <b>CONTINUOUS</b>	
 <b>SHOOTING +MOTION</b>	As above, except that image stabilization is performed only when the shutter button is pressed halfway (focus mode <b>MF-E</b> only) or the shutter is released. If <b>+MOTION</b> is selected, the camera will adjust shutter speed to reduce motion blur when a moving objects are detected.
 <b>SHOOTING ONLY</b>	
<b>OFF</b>	Image stabilization off. Choose this option when using a tripod.

 **+MOTION** has no effect when sensitivity is set to a fixed value, and may also be unavailable at some other combinations of settings. The effect may vary with lighting conditions and the speed at which the object is moving.

This option is available only with lenses that support image stabilization.

## DIGITAL IMAGE STABILIZER

Choose whether to enable digital image stabilization during movie recording.

Options	
<b>ON</b>	<b>OFF</b>



## WIRELESS COMMUNICATION

Connect to smartphones running the latest version of the FUJIFILM Camera Remote app. The smartphone can be used to browse the images on the camera, download selected images, control the camera remotely, or upload location data to the camera.



For downloads and other information, visit:

[http://app.fujifilm-dsc.com/en/camera\\_remote/](http://app.fujifilm-dsc.com/en/camera_remote/)

## SHUTTER TYPE

Choose the shutter type. Choose the electronic shutter to mute the shutter sound.

Option	Description
<b>MS MECHANICAL SHUTTER</b>	Take pictures with the mechanical shutter.
<b>ES ELECTRONIC SHUTTER</b>	Take pictures with the electronic shutter.
<b>MS MECHANICAL+ES ELECTRONIC</b>	The camera chooses the shutter type according to shooting conditions.



When the electronic shutter is used, distortion may be visible in shots of moving subjects and in hand-held shots taken at high shutter speeds, while banding and fog may occur in shots taken under fluorescent lights or other flickering or erratic illumination. When taking pictures with the shutter muted, respect your subjects' image rights and right to privacy.



When the electronic shutter is used, the flash is disabled, sensitivity is restricted to values of ISO 12800–200, and long exposure noise reduction has no effect.

 **ELECTRONIC ZOOM SETTING**

Select **ON** to enable power zoom when the LCD monitor is rotated 180°. Zoom can be adjusted by rotating the sub-command dial.



# Playback and the Playback Menu

# 7

## The Playback Display

This section lists the indicators that may be displayed during playback.

**!** For illustrative purposes, displays are shown with all indicators lit.

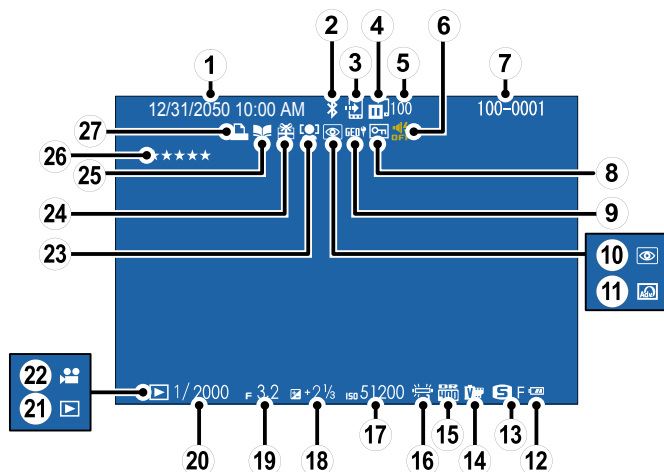

① Date and time.....	31, 142	⑭ Film simulation .....	106
② Bluetooth ON/OFF.....	152	⑮ Dynamic range .....	105
③ Image transfer order.....	129	⑯ White balance .....	110
④ Image transfer status.....	129	⑰ Sensitivity.....	102
⑤ Number of frames selected for upload .....	129	⑱ Exposure compensation.....	75
⑥ Sound and flash indicator .....	143	⑲ Aperture.....	49, 52, 53
⑦ Frame number.....	150	⑳ Shutter speed .....	49, 50, 53
⑧ Protected image.....	135	㉑ Playback mode indicator .....	38
⑨ Location data.....	152, 154	㉒ Movie icon.....	45
⑩ Red-eye removal indicator.....	136	㉓ Face detection indicator .....	100
⑪ Advanced filter.....	62	㉔ Gift image .....	38
⑫ Battery level.....	30	㉕ Photobook assist indicator .....	137
⑬ Image size/quality.....	103, 104	㉖ Rating.....	125
		㉗ DPOF print indicator.....	139

## The DISP/BACK Button

The **DISP/BACK** button controls the display of indicators during playback.

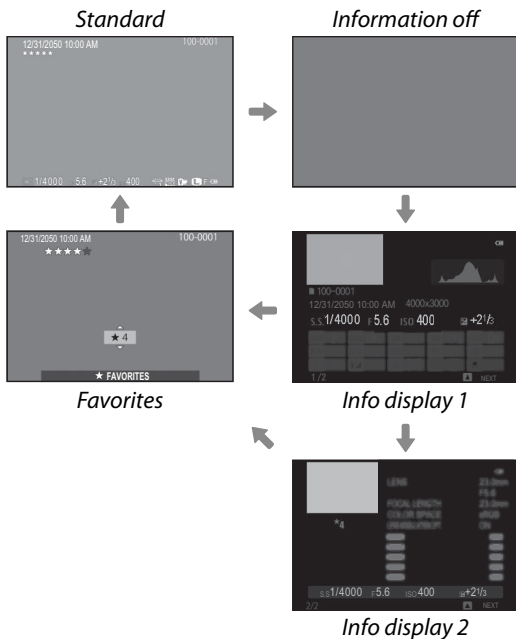
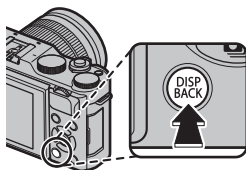

### Favorites: Rating Pictures

To rate the current picture, press **DISP/BACK** and press the selector up and down to select from zero to five stars.

**Zooming in on the Focus Point**

Press the center of the sub-command dial to zoom in on the focus point. Press the center of the sub-command dial again to return to full-frame playback.

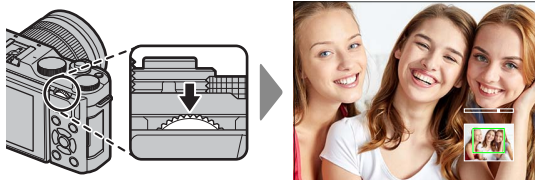

## Viewing Pictures

Read this section for information on playback zoom and multi-frame playback.

Use the sub-command dial to go from full-frame playback to playback zoom or multi-frame playback.

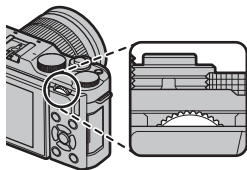

*Full-frame playback*



*Multi-frame playback*



*Nine-frame view*



*Hundred-frame view*

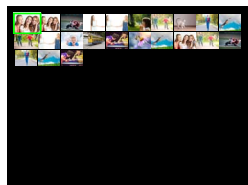

*Playback zoom*



*Medium zoom*



*Maximum zoom*



## Playback Zoom

Rotate the sub-command dial to zoom in or out on pictures in full-frame playback. When the picture is zoomed in, the selector can be used to view areas of the image not currently visible in the display. To exit zoom, press **DISP/BACK**, **MENU/OK**, or the center of the sub-command dial.

 The maximum zoom ratio varies with the option selected for **IMAGE SIZE**. Playback zoom is not available with cropped or re-sized copies saved at a size of **640**.

### Scroll

When the picture is zoomed in, the selector can be used to view areas of the image not currently visible in the display.



*Navigation window*

## Multi-Frame Playback



To view multiple images, rotate the sub-command dial left when a picture is displayed full frame. Use the sub-command dial to choose the number of images displayed.

 Use the selector to highlight images and press **MENU/OK** to view the highlighted image full frame. In the nine- and hundred-frame displays, press the selector up or down to view more pictures.



## The Playback Menu ( / / )

Adjust playback settings.

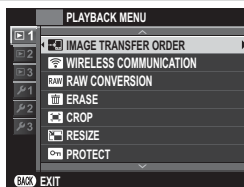

The playback menu is displayed when you press **MENU/OK** in playback mode. Choose from tabs , , or .



### IMAGE TRANSFER ORDER

Select photos for upload to a paired smartphone or tablet.

- 1 Select  **IMAGE TRANSFER ORDER** > **SELECT FRAMES** in the playback menu.
- 2 Highlight photos and press **MENU/OK** to select or deselect. Repeat until all the desired photos have been selected.
- 3 Press **MENU/OK** to exit to playback.

 If **ON** is selected for  **CONNECTION SETTING** > **Bluetooth SETTINGS** > **Bluetooth ON/OFF**, upload will begin shortly after you exit to playback or turn the camera off.

 Image transfer orders can contain a maximum of 999 pictures. Protected pictures, RAW images, "gift" pictures, and movies cannot be selected for upload.

When **WIRELESS COMMUNICATION** is assigned to the **Fn** button and **PAIRING/TRANSFER ORDER** is selected for  **CONNECTION SETTING** > **GENERAL SETTINGS** >  **BUTTON SETTING**, the **Fn** button can be used to select pictures for upload. To deselect all images, select **RESET ORDER** for **IMAGE TRANSFER ORDER**. To upload pictures as they are taken, select **ON** for  **CONNECTION SETTING** > **Bluetooth SETTINGS** > **AUTO IMAGE TRANSFER**.

## WIRELESS COMMUNICATION

Connect to smartphones running the latest version of the FUJIFILM Camera Remote app. The smartphone can be used to browse the images on the camera, download selected images, control the camera remotely, or upload location data to the camera.

For downloads and other information, visit:  
[http://app.fujifilm-dsc.com/en/camera\\_remote/](http://app.fujifilm-dsc.com/en/camera_remote/)

## RAW CONVERSION

RAW pictures store information on camera settings separately from the data captured by the camera image sensor. Using **RAW CONVERSION**, you can create JPEG copies of RAW pictures using different options for the settings listed on page 131. The original image data are unaffected, allowing a single RAW image to be processed in a multitude of different ways.

- 1 With a RAW picture displayed, press **MENU/OK** to display the playback menu.
- 2 Press the selector up or down to highlight **RAW CONVERSION** in the playback menu and press **MENU/OK** to display settings.

These options can also be displayed by pressing the **Q** button during playback.

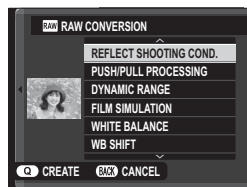

- 3 Press the selector up or down to highlight a setting and press the selector right to display options. Press the selector up or down to highlight the desired option and press **MENU/OK** to select and return to the settings list. Repeat this step to adjust additional settings.

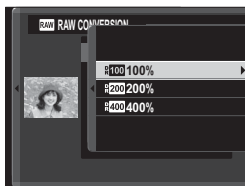

- 4 Press the **Q** button to preview the JPEG copy and press **MENU/OK** to save.

The settings that can be adjusted when converting pictures from RAW to JPEG are:

Setting	Description
<b>REFLECT SHOOTING COND.</b>	Create a JPEG copy using the settings in effect at the time the photo was taken.
<b>PUSH/PULL PROCESSING</b>	Adjust exposure.
<b>DYNAMIC RANGE</b>	Enhance details in highlights for natural contrast.
<b>FILM SIMULATION</b>	Simulate the effects of different types of film.
<b>WHITE BALANCE</b>	Adjust white balance.
<b>WB SHIFT</b>	Fine-tune white balance.
<b>COLOR</b>	Adjust color density.
<b>SHARPNESS</b>	Sharpen or soften outlines.
<b>HIGHLIGHT TONE</b>	Adjust highlights.
<b>SHADOW TONE</b>	Adjust shadows.
<b>NOISE REDUCTION</b>	Process the copy to reduce mottling.
<b>COLOR SPACE</b>	Choose the color space used for color reproduction.

## ERASE

Delete individual pictures, multiple selected pictures, or all pictures.

 Deleted pictures cannot be recovered. Protect important pictures or copy them to a computer or other storage device before proceeding.

Option	Description
<b>FRAME</b>	Delete pictures one at a time.
<b>SELECTED FRAMES</b>	Delete multiple selected pictures.
<b>ALL FRAMES</b>	Delete all unprotected pictures.

### FRAME

- 1 Select **FRAME** for **ERASE** in the playback menu.
- 2 Press the selector left or right to scroll through pictures and press **MENU/OK** to delete (a confirmation dialog is not displayed). Repeat to delete additional pictures.

## SELECTED FRAMES

---

- 1 Select **SELECTED FRAMES** for **ERASE** in the playback menu.
- 2 Highlight pictures and press **MENU/OK** to select or deselect (pictures in photobooks or printer orders are shown by **■**). Selected pictures are indicated by check marks (**☑**).
- 3 When the operation is complete, press **DISP/BACK** to display a confirmation dialog.
- 4 Highlight **OK** and press **MENU/OK** to delete the selected pictures.

## ALL FRAMES

---

- 1 Select **ALL FRAMES** for **ERASE** in the playback menu.
- 2 A confirmation dialog will be displayed; highlight **OK** and press **MENU/OK** to delete all unprotected pictures.





Pressing **DISP/BACK** cancels deletion; note that any pictures deleted before the button was pressed cannot be recovered.

If a message appears stating that the selected images are part of a DPOF print order, press **MENU/OK** to delete the pictures.

## CROP

Create a cropped copy of the current picture.

- 1 Display the desired picture.
- 2 Select  **CROP** in the playback menu.
- 3 Use the sub-command dial to zoom in and out and press the selector up, down, left, or right to scroll the picture until the desired portion is displayed.
- 4 Press **MENU/OK** to display a confirmation dialog.
- 5 Press **MENU/OK** again to save the cropped copy to a separate file.

 Larger crops produce larger copies; all copies have an aspect ratio of 3:2. If the size of the final copy will be **640**, **YES** will be displayed in yellow.

## RESIZE

Create a small copy of the current picture.

- 1 Display the desired picture.
- 2 Select  **RESIZE** in the playback menu.
- 3 Highlight a size and press **MENU/OK** to display a confirmation dialog.
- 4 Press **MENU/OK** again to save the resized copy to a separate file.

 The sizes available vary with the size of the original image.

## PROTECT

Protect pictures from accidental deletion. Highlight one of the following options and press **MENU/OK**.

- **FRAME:** Protect selected pictures. Press the selector left or right to view pictures and press **MENU/OK** to select or deselect. Press **DISP/BACK** when the operation is complete.
- **SET ALL:** Protect all pictures.
- **RESET ALL:** Remove protection from all pictures.

 Protected pictures will be deleted when the memory card is formatted.

## IMAGE ROTATE

Rotate pictures.

- 1 Display the desired picture.
- 2 Select  **IMAGE ROTATE** in the playback menu.
- 3 Press the selector down to rotate the picture 90° clockwise, up to rotate it 90° counterclockwise.
- 4 Press **MENU/OK**. The picture will automatically be displayed in the selected orientation whenever it is played back on the camera.

 Protected pictures cannot be rotated. Remove protection before rotating pictures.



The camera may not be able to rotate pictures created with other devices. Pictures rotated on the camera will not be rotated when viewed on a computer or on other cameras.

Pictures taken with  **SCREEN SET-UP > AUTOROTATE PB** are automatically displayed in the correct orientation during playback.

## RED EYE REMOVAL

Remove red-eye from portraits. The camera will analyze the image; if red-eye is detected, the image will be processed to create a copy with reduced red-eye.

- 1 Display the desired picture.
- 2 Select  **RED EYE REMOVAL** in the playback menu.
- 3 Press **MENU/OK**.

 Results vary depending on the scene and the camera's success in detecting faces. Red eye cannot be removed from pictures that have already been processed using red-eye removal, which are indicated by a  icon during playback.

The amount of time needed to process the image varies with the number of faces detected.

Red eye removal cannot be performed on RAW images.

## SLIDE SHOW

View pictures in an automated slide show. Press **MENU/OK** to start and press the selector right or left to skip ahead or back. Press **DISP/BACK** at any time during the show to view on-screen help. The show can be ended at any time by pressing **MENU/OK**.

 The camera will not turn off automatically while a slide show is in progress.



## PHOTOBOOK ASSIST

Create books from your favorite photos.

### Creating a Photobook

- 1 Select **NEW BOOK** for  **PHOTOBOOK ASSIST** in the playback menu.
- 2 Scroll through the images and press the selector up to select or deselect. Press **MENU/OK** to exit when the book is complete.

 Neither photographs 640 or smaller nor movies can be selected for photobooks.

The first picture selected becomes the cover image. Press the selector down to select the current image for the cover instead.

- 3 Highlight **COMPLETE PHOTOBOOK** and press **MENU/OK** (to select all photos for the book, choose **SELECT ALL**). The new book will be added to the list in the photobook assist menu.

 Books can contain up to 300 pictures. Books that contain no photos are automatically deleted.

### Photobooks

Photobooks can be copied to a computer using MyFinePix Studio software.

## Viewing Photobooks

Highlight a book in the photobook assist menu and press **MENU/OK** to display the book, then press the selector left or right to scroll through the pictures.

## Editing and Deleting Photobooks

Display the photobook and press **MENU/OK**. The following options will be displayed; select the desired option and follow the on-screen instructions.

- **EDIT:** Edit the book as described in “Creating a Photobook”.
- **ERASE:** Delete the book.

## PC AUTO SAVE

Upload pictures from the camera to a computer running the latest version of FUJIFILM PC AutoSave (note that you must first install the software and configure the computer as a destination for images copied from the camera).





For downloads and other information, visit:

[http://app.fujifilm-dsc.com/en/pc\\_autosave/](http://app.fujifilm-dsc.com/en/pc_autosave/)

## PRINT ORDER (DPOF)

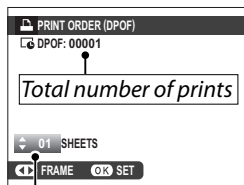

Create a digital “print order” for DPOF-compatible printers.

- 1 Select  **PRINT ORDER (DPOF)** in the playback menu.
- 2 Select **WITH DATE**  to print the date of recording on pictures, **WITHOUT DATE** to print pictures without dates, or **RESET ALL** to remove all pictures from the print order before proceeding.
- 3 Display a picture you wish to include in or remove from the print order.
- 4 Press the selector up or down to choose the number of copies (up to 99). To remove a picture from the order, press the selector down until the number of copies is 0.



*Number of copies*

- 5 Repeat steps 3–4 to complete the print order.
- 6 The total number of prints is displayed in the monitor. Press **MENU/OK** to exit.

 The pictures in the current print order are indicated by a  icon during playback.

Print orders can contain a maximum of 999 pictures.

If a memory card is inserted containing a print order created by another camera, you will need to delete the order before creating as described above.



## instax PRINTER PRINT

Print pictures on optional FUJIFILM instax SHARE printers ( 178).

## DISP ASPECT

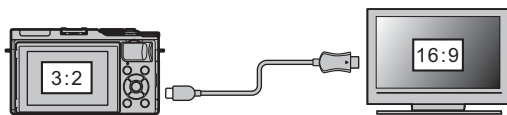
Choose how High Definition (HD) devices display pictures with an aspect ratio of 3:2 (this option is available only when an HDMI cable is connected). Select 16:9 to display the image so that it fills the screen with its top and bottom cropped out, 3:2 to display the entire image with black bands at either side.





		Option	
		16:9	3:2
Display			

# The Setup Menus

# 8

## The Setup Menu ( / / )

Adjust basic camera settings.

To access basic camera settings, press **MENU/OK** and select tab , , or .

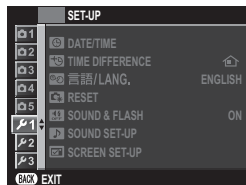





### DATE/TIME

Set the camera clock (  33).

### TIME DIFFERENCE

Switch the camera clock instantly from your home time zone to the local time at your destination when traveling. To specify the difference between your local and home time zone:

- 1 Highlight  **LOCAL** and press **MENU/OK**.
- 2 Use the selector to choose the time difference between local time and your home time zone. Press **MENU/OK** when settings are complete.

To set the camera clock to local time, highlight  **LOCAL** and press **MENU/OK**. To set the clock to the time in your home time zone, select  **HOME**. If  **LOCAL** is selected,  will be displayed in yellow for about three seconds when the camera is turned on.

#### Options

 LOCAL

 HOME



### 言語/LANG.

Choose a language (  33).

## RESET

Reset shooting or setup menu options to default values.

- 1 Highlight the desired option and press **MENU/OK**.

Option	Description
<b>SHOOTING MENU RESET</b>	Reset all shooting menu settings other than custom white balance to default values.
<b>SET-UP RESET</b>	Reset all setup menu settings other than  <b>DATE/TIME</b> ,  <b>TIME DIFFERENCE</b> , and  <b>CONNECTION SETTING</b> to default values.

- 2 A confirmation dialog will be displayed; highlight **OK** and press **MENU/OK**.

## SOUND & FLASH

Select **OFF** to disable the speaker, flash, and illuminator in situations in which camera sounds or lights may be unwelcome.

Options	
<b>ON</b>	<b>OFF</b>

 **OFF** appears in the display when **OFF** is selected.

## SOUND SET-UP

Adjust sound settings.

### **OPERATION VOL.**

Adjust the volume of the sounds produced when camera controls are operated. Choose OFF to disable control sounds.

#### Options

 (high)

 (medium)

 (low)

OFF (mute)

### **SHUTTER VOLUME**

Adjust the volume of the sounds produced by the electronic shutter. Choose OFF to disable the shutter sound.

#### Options

 (high)

 (medium)

 (low)

OFF (mute)

### **SHUTTER SOUND**

Choose the sound made by the electronic shutter.

#### Options

 1

 2

 3

### **PLAYBACK VOLUME**

Adjust the volume for movie playback. Choose from 10 options between 10 (high) and 1 (low) or select 0 to mute audio during movie playback.

#### Options

10

9

8

7

6

5

4

3

2

1

0



## SCREEN SET-UP

Adjust display settings.

### **IMAGE DISP.**

Choose how long images are displayed after shooting. Colors may differ slightly from those in the final image and “noise” motling may be visible at high sensitivities. Note that at some settings, the camera will display pictures after shooting regardless of the option selected.

Option	Description
<b>CONTINUOUS</b>	Pictures are displayed until the <b>MENU/OK</b> button is pressed or the shutter button is pressed halfway. To zoom in on the active focus point, press the center of the sub-command dial; press again to cancel zoom.
<b>1.5 SEC</b>	Pictures are displayed for the selected time or until the shutter button is pressed halfway.
<b>0.5 SEC</b>	
<b>OFF</b>	Pictures are not displayed after shooting.

### **PREVIEW EXP. IN MANUAL MODE**

Select **ON** to enable exposure preview in manual exposure mode.

Options	
<b>ON</b>	<b>OFF</b>

 Select **OFF** when using the flash or on other occasions on which exposure may change when the picture is taken.

### **LCD BRIGHTNESS**

Adjust monitor brightness.

Options										
+5	+4	+3	+2	+1	0	-1	-2	-3	-4	-5

### **LCD COLOR**

Adjust monitor hue.

Options										
+5	+4	+3	+2	+1	0	-1	-2	-3	-4	-5

## PREVIEW PIC. EFFECT



Choose **ON** to preview the effects of film simulation, white balance, and other settings in the monitor, **OFF** to make shadows in low-contrast, back-lit scenes and other hard-to-see subjects more visible.

Options	
ON	OFF

 If **OFF** is selected, the effects of camera settings will not be visible in the monitor and colors and tone will differ from those in the final picture. The display will however be adjusted to show the effects of advanced filters and of monochrome and sepia settings.

## FRAMING GUIDELINE

Choose a framing grid for shooting mode.

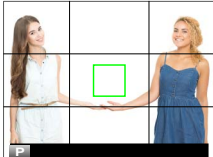
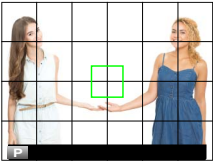
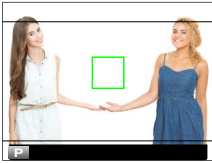
Option		
 GRID 9	 GRID 24	 HD FRAMING
 <p><i>For "rule of thirds" composition.</i></p>	 <p><i>A six-by-four grid.</i></p>	 <p><i>Frame HD pictures in the crop shown by the lines at the top and bottom of the display.</i></p>

 Framing guides are not shown at default settings but can be displayed using  **SCREEN SET-UP > DISP. CUSTOM SETTING** ( 11).

**AUTOROTATE PB**

Choose **ON** to automatically rotate “tall” (portrait-orientation) pictures during playback.

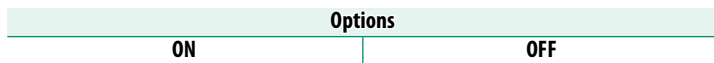
**FOCUS CHECK**

If **ON** is selected, the display will automatically zoom in on the selected focus area when the focus ring is rotated in manual focus mode.



 Pressing the center of the sub-command dial cancels focus zoom.

**FOCUS SCALE UNITS**

Choose the units used for the focus distance indicator.

**DISP. CUSTOM SETTING**

Choose items for the standard display ( 11).

## **BUTTON SETTING**

Choose the roles played by camera controls.

### **FUNCTION (Fn) SETTING**

Choose the roles played by the function buttons ( 162).

 The **FUNCTION (Fn) SETTING** menu can also be displayed by pressing and holding the **Fn** or **DISP/BACK** button.

### **EDIT/SAVE QUICK MENU**

Choose the items displayed in the quick menu ( 161).

 The quick menu can also be accessed in shooting mode by holding the **Q** button.

## **FOCUS RING**

Choose the direction in which the focus ring is rotated to increase the focus distance.

### Options

 **CW** (clockwise)

 **CCW** (counterclockwise)

## **TOUCH SCREEN SETTING**

Enable or disable touch-screen controls.

### Options

**ON**

**OFF**

## POWER MANAGEMENT

Adjust power management settings.

### **AUTO POWER OFF**

Choose the length of time before the camera turns off automatically when no operations are performed. Shorter times increase battery life; if **OFF** is selected, the camera must be turned off manually.

Options		
5 MIN	2 MIN	OFF

### **HIGH PERFORMANCE**

Select **ON** for faster focus and to reduce the time needed to restart the camera after it has been turned off.

Options	
ON	OFF

## SENSOR CLEANING

Remove dust from the camera image sensor.

- **OK:** Clean the sensor immediately.
- **WHEN SWITCHED ON:** Sensor cleaning will be performed when the camera is turned on.
- **WHEN SWITCHED OFF:** Sensor cleaning will be performed when the camera turns off (sensor cleaning is not however performed if the camera turns off in playback mode).

 Dust that cannot be removed using sensor cleaning can be removed manually.

## SAVE DATA SET-UP

Adjust file management settings.

### FRAME NO.

New pictures are stored in image files named using a four-digit file number assigned by adding one to the last file number used. The file number is displayed during playback as shown. **FRAME NO.** controls whether file numbering is reset to 0001 when a new memory card is inserted or the current memory card is formatted.

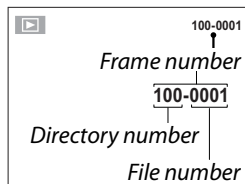

Option	Description
<b>CONTINUOUS</b>	Numbering continues from the last file number used or the first available file number, whichever is higher. Choose this option to reduce the number of pictures with duplicate file names.
<b>RENEW</b>	Numbering is reset to 0001 after formatting or when a new memory card is inserted.

 If the frame number reaches 999-9999, the shutter release will be disabled. Format the memory card after transferring to a computer any pictures you wish to keep.

Selecting  **RESET** sets **FRAME NO.** to **CONTINUOUS** but does not reset the file number.

Frame numbers for pictures taken with other cameras may differ.

### SAVE ORG IMAGE

Choose **ON** to save unprocessed copies of pictures taken using

 **FLASH SET-UP > RED EYE REMOVAL.**

Options	
<b>ON</b>	<b>OFF</b>

**EDIT FILE NAME**



Change the file name prefix. sRGB images use a four-letter prefix (default “DSCF”), Adobe RGB images a three-letter prefix (“DSF”) preceded by an underscore.

Option	Default prefix	Sample file name
sRGB	DSCF	ABCD0001
AdobeRGB	_DSF	_ABC0001

 File name prefixes can be edited using touch controls.

**DATE STAMP**

Stamp the time and/or date of recording on photographs as they are taken.

Option	Description
 + 	Stamp new photographs with the date and time of recording.
	Stamp new photographs with the date of recording.
<b>OFF</b>	Do not stamp the time and date on new photographs.

 Time and date stamps cannot be deleted. Turn **DATE STAMP** off to prevent time and date stamps appearing on new photographs.

If the camera clock is not set, you will be prompted to set the clock to the current date and time ( 31, 33).

We recommend that you turn the DPOF “print date” option off when printing images with a time and date stamp ( 139).

Time and date stamps do not appear on movies or RAW images or on shots taken using 4K burst or multi-focus.

**COLOR SPACE**

Choose the gamut of colors available for color reproduction.

Option	Description
sRGB	Recommended in most situations.
Adobe RGB	For commercial printing.

## CONNECTION SETTING

Adjust settings for connection to wireless devices, including smartphones, computers, and FUJIFILM instax SHARE printers.



For more information on wireless connections, visit:

<http://fujifilm-dsc.com/wifi/>

### **Bluetooth SETTINGS**

Adjust Bluetooth settings.

Option	Description
<b>PAIRING REGISTRATION</b>	To pair the camera with a smartphone or tablet, select this option, then launch FUJIFILM Camera Remote on the smart device and tap <b>PAIRING REGISTRATION</b> .
<b>DELETE PAIRING REG.</b>	End pairing.
<b>Bluetooth ON/OFF</b>	<ul style="list-style-type: none"><li>• <b>ON:</b> The camera automatically establishes a Bluetooth connection with paired devices when turned on.</li><li>• <b>OFF:</b> The camera does not connect via Bluetooth.</li></ul>
<b>AUTO IMAGE TRANSFER</b>	<ul style="list-style-type: none"><li>• <b>ON:</b> Mark JPEG images for upload as they are taken.</li><li>• <b>OFF:</b> Photos are not marked for upload as they are taken.</li></ul>
<b>SMARTPHONE SYNC. SETTING</b>	Choose whether to synchronize the camera to the time and/or location provided by a paired smartphone. <ul style="list-style-type: none"><li>• <b>LOCATION&amp;TIME:</b> Synchronize the time and location.</li><li>• <b>LOCATION:</b> Synchronize the location.</li><li>• <b>TIME:</b> Synchronize the time.</li><li>• <b>OFF:</b> Synchronization off.</li></ul>



Install the latest version of the FUJIFILM Camera Remote app on your smartphone or tablet before pairing the device with your camera or uploading images.

When **ON** is selected for both **Bluetooth ON/OFF** and **AUTO IMAGE TRANSFER**, upload to paired devices will begin shortly after you exit to playback or turn the camera off.

If **AUTO IMAGE TRANSFER** is off, pictures can be marked for transfer using the  **IMAGE TRANSFER ORDER** option in the playback menu.



**PC AUTO SAVE SETTINGS**

Adjust settings for connection to computers via wireless LAN.

Option	Description
<b>PC AUTO SAVE SETTING</b>	Choose the method used for connection to computers via a wireless LAN. <ul style="list-style-type: none"> <li>• <b>SIMPLE SETUP:</b> Connect using WPS.</li> <li>• <b>MANUAL SETUP:</b> Choose the network from a list (<b>SELECT FROM NETWORK LIST</b>) or enter the name manually (<b>ENTER SSID</b>).</li> </ul>
<b>DELETE REGISTERED DESTINATION PC</b>	Remove selected destinations.
<b>DETAILS OF PREVIOUS CONNECTION</b>	View computers to which the camera has recently connected.

**instax PRINTER CONNECTION SETTING**

Adjust settings for connection to optional FUJIFILM instax SHARE printers.

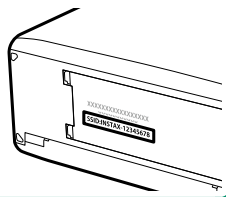

**The Printer Name (SSID) and Password**

The printer name (SSID) can be found on the bottom of the printer; the default password is "1111". If you have already chosen a different password to print from a smartphone, enter that password instead.



## **GENERAL SETTINGS**

Adjust settings for connection to wireless networks.

Option	Description
<b>NAME</b>	Choose a name ( <b>NAME</b> ) to identify the camera on the wireless network (the camera is assigned a unique name by default).
<b>RESIZE IMAGE FOR SMARTPHONE</b> 	Choose <b>ON</b> (the default setting, recommended in most circumstances) to resize larger images to <b>3M</b> for upload to smartphones, <b>OFF</b> to upload images at their original size. Resizing applies only to the copy uploaded to the smartphone; the original is not affected.
<b>GEOTAGGING</b>	Choose whether location data downloaded from a smartphone are embedded in pictures as they are taken.
<b>LOCATION INFO</b>	Display the location data last downloaded from a smartphone.
 <b>BUTTON SETTING</b>	Choose the role played by the <b>Fn</b> button when it is assigned the <b>WIRELESS COMMUNICATION</b> function. <ul style="list-style-type: none"> <li>• <b>PAIRING/TRANSFER ORDER:</b> The <b>Fn</b> button can be used for pairing and selecting images for transfer.</li> <li>• <b>WIRELESS COMMUNICATION:</b> The <b>Fn</b> button can be used for wireless connections.</li> </ul>

## **INFORMATION**

View the camera's MAC and Bluetooth address.

## **RESET WIRELESS SETTING**

Restore wireless settings to their default values.

**FORMAT**

To format a memory card:

- 1 Highlight **FORMAT** in the setup menu and press **MENU/OK**.
- 2 A confirmation dialog will be displayed. To format the memory card, highlight **OK** and press **MENU/OK**. To exit without formatting the memory card, select **CANCEL** or press **DISP/BACK**.

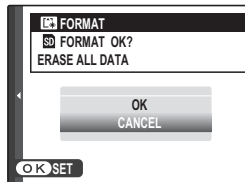

- !** All data—including protected pictures—will be deleted from the memory card. Be sure important files have been copied to a computer or other storage device.

Do not open the battery-chamber cover during formatting.

# MEMO

---

---

---

---

---

---

---

---

---

---

---

---

---

---

---

---

---

---

---

---

---

---

---

---

---

---

---

---

---

# 9

## Shortcuts

## Shortcut Options

---

Customize camera controls to suit your style or situation.

---

Frequently-used options can be added to the **Q** menu or assigned to the **Fn** (function) button for direct access:

- **The Q menu** (📖 159): The **Q** menu is displayed by pressing the **Q** button. Use the **Q** menu to view or change the options selected for frequently-used menu items.
- **The function button** (📖 162): Use the function button for direct access to selected features.

## The Q (Quick Menu) Button

Press **Q** for quick access to selected options.

### The Quick Menu Display

At default settings, the quick menu contains the following items:

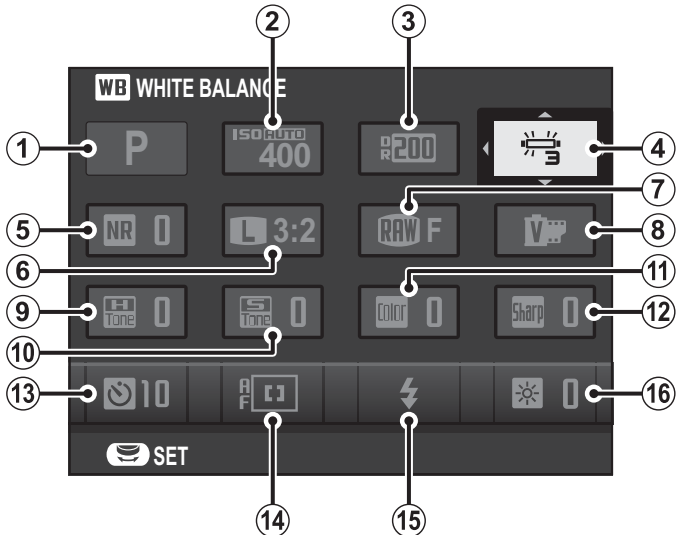

- ① SHOOTING MODE
- ② ISO
- ③ DYNAMIC RANGE
- ④ WHITE BALANCE
- ⑤ NOISE REDUCTION
- ⑥ IMAGE SIZE
- ⑦ IMAGE QUALITY
- ⑧ FILM SIMULATION

- ⑨ HIGHLIGHT TONE
- ⑩ SHADOW TONE
- ⑪ COLOR
- ⑫ SHARPNESS
- ⑬ SELF-TIMER
- ⑭ AF MODE
- ⑮ FLASH MODE
- ⑯ LCD BRIGHTNESS

## Viewing and Changing Settings

- 1 Press **Q** to display the quick menu during shooting.

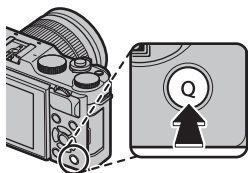

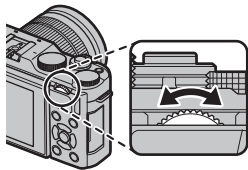
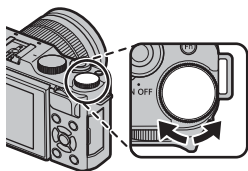

- 2 Use the selector to highlight items and rotate the main/sub-command dial to change.



- 3 Press **Q** to exit when settings are complete.

 The shooting mode is the current shooting mode and cannot be changed from the quick menu.

 **CUSTOM** and  **COLOR TEMPERATURE** white balance options cannot be accessed using the **Q** button. Use a function button or the shooting menu.



## Editing the Quick Menu

To choose the items displayed in the quick menu:

- 1 Press and hold the **Q** button during shooting.

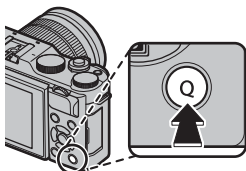

- 2 The current quick menu will be displayed; use the selector to highlight the item you wish to change and press **MENU/OK**.
- 3 Highlight any of the following options and press **MENU/OK** to assign it to the selected position.

- ISO
- DYNAMIC RANGE
- WHITE BALANCE
- NOISE REDUCTION
- IMAGE SIZE
- IMAGE QUALITY
- FILM SIMULATION
- HIGHLIGHT TONE
- SHADOW TONE
- COLOR
- SHARPNESS
- SELF-TIMER
- FACE/EYE DETECTION SETTING
- PHOTOMETRY
- AF MODE
- FOCUS MODE
- FLASH MODE
- FLASH COMPENSATION
- IS MODE
- MF ASSIST
- MOVIE MODE
- MOVIE ISO
- MIC LEVEL ADJUSTMENT
- SOUND & FLASH
- LCD BRIGHTNESS
- LCD COLOR
- SHUTTERTYPE
- NONE

 Select **NONE** to assign no option to the selected position.

 The quick menu can also be edited using the **⚙️ BUTTON SETTING > EDIT/SAVE QUICK MENU** option in the setup menu.

## The Fn (Function) Button

Assign a role to the function button for quick access to the selected feature.

Pressing the **Fn** button displays options for the selected setting.

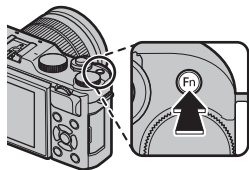

### Assigning a Role to the Function Button

The role played by the **Fn** button can be selected using the **BUTTON SETTING > FUNCTION (Fn) SETTING** option in the setup menu.

- PREVIEW DEPTH OF FIELD
- ISO
- SELF-TIMER
- IMAGE SIZE
- IMAGE QUALITY
- DYNAMIC RANGE
- FILM SIMULATION
- WHITE BALANCE
- PHOTOMETRY
- TOUCH ZOOM
- AE BKT SETTING
- AE-LOCK
- AF-LOCK
- AE/AF LOCK
- INSTANT AF
- AF MODE
- FOCUS MODE
- FOCUS AREA
- RELEASE TYPE
- FLASH MODE
- FLASH COMPENSATION
- MOVIE
- FACE/EYE DETECTION SETTING
- RAW
- WIRELESS COMMUNICATION
- AUTO IMAGE TRANSFER
- Bluetooth ON/OFF
- SHUTTER TYPE
- PREVIEW EXP. IN MANUAL MODE
- PREVIEW PIC. EFFECT
- NONE

 To disable the **Fn** button, choose **NONE**.

The **FUNCTION (Fn) SETTING** menu can also be displayed by pressing and holding the **Fn** or **DISP/BACK** button.

# 10 Peripherals and Optional Accessories

## Lenses

The camera can be used with lenses for the FUJIFILM X-mount.

### Lens Parts

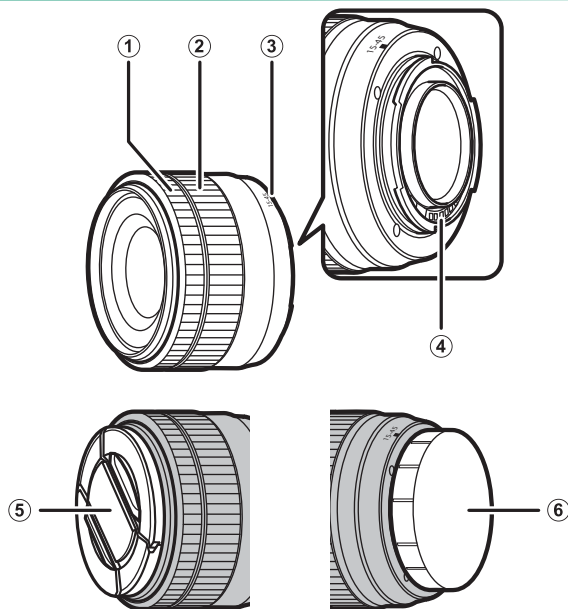

- ① Focus ring
- ② Zoom ring
- ③ Mounting marks

- ④ Lens signal contacts
- ⑤ Front lens cap
- ⑥ Rear lens cap

 A XC15-45mmF3.5-5.6 OIS PZ is used here for illustrative purposes.

## Power Zoom

When **ON** is selected for **ELECTRONIC ZOOM SETTING**, the sub-command dial can be used to adjust zoom when the LCD monitor is rotated 180°.

 The focus ring can be used to adjust zoom when autofocus is enabled.

## Removing Lens Caps

Remove lens caps as shown.

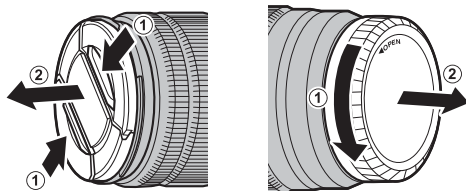

 Lens caps may differ from those shown.

## Lenses with Lens Hoods

When attached, lens hoods reduce glare and protect the front lens element.

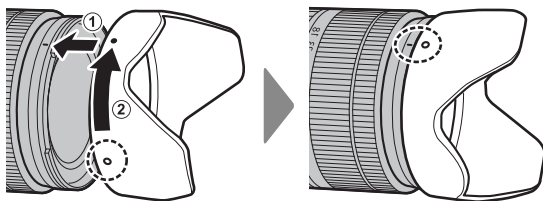

## Lenses with Aperture Rings

At settings other than **A**, you can adjust aperture by rotating the lens aperture ring (exposure modes **A** and **M**).

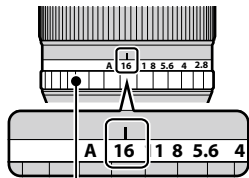

Aperture ring

### The Aperture Mode Switch

If the lens has an aperture mode switch, aperture can be adjusted manually by sliding the switch to  and rotating the aperture ring.

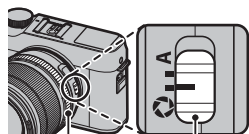

Aperture ring

Aperture mode switch

- When the aperture ring is set to **A**, rotate the sub-command dial to adjust aperture.

## Lenses with O.I.S. Switches

If the lens supports optical image stabilization (O.I.S.), the image stabilization mode can be chosen in the camera menus. To activate image stabilization, slide the O.I.S. switch to **ON**.

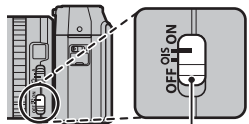

O.I.S. switch

## Manual Focus Lenses

Slide the focus ring to the front for autofocus.

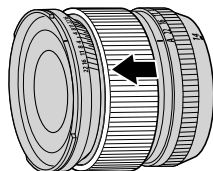

For manual focus, slide the focus ring to the back and rotate it while checking the results in the camera display. The focus distance and depth-of-field indicators can be used to assist manual focus.

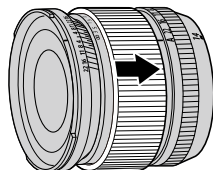

 Note that manual focus may not be available in all shooting modes.

### The Depth-of-Field Indicator

The depth-of-field indicator shows the approximate depth of field (the distance in front of and behind the focus point that appears to be in focus). The indicator is displayed in film format.

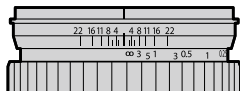

## Lens Care

Use a blower to remove dust, then gently wipe with a soft, dry cloth. Any remaining stains can be removed by wiping gently with a piece of FUJIFILM lens-cleaning paper to which a small amount of lens-cleaning fluid has been applied. Replace the front and rear caps when the lens is not in use.



# 11 Connections

## HDMI Output

Camera shooting and playback displays can be output to HDMI devices.

### Connecting to HDMI Devices

Connect the camera to TVs or other HDMI devices using a third-party HDMI cable.

- 1 Turn the camera off.
- 2 Connect the cable as shown below, making sure the connectors are fully inserted.

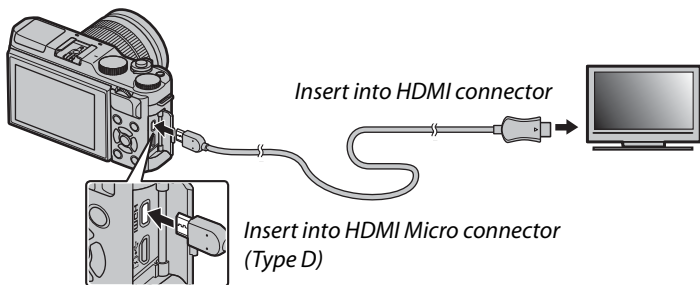

**!** Use an HDMI cable no more than 1.5 m (4.9 ft.) long.

- 3 Configure the device for HDMI input as described in the documentation supplied with the device.
- 4 Turn the camera on. You can now shoot and play back pictures while viewing the television display and save pictures to the HDMI device.

**!** The USB cable cannot be used while an HDMI cable is connected.

## Shooting

Shoot photos and record movies while viewing the scene through the camera lens or saving footage to the HDMI device.

 This feature can be used to save 4K and Full HD movies to an HDMI recorder.

## Playback

To start playback, press the camera  button. The camera monitor turns off and pictures and movies are output to the HDMI device. Note that the camera volume controls have no effect on sounds played on the TV; use the television volume controls to adjust the volume.

 Some televisions may briefly display a black screen when movie playback begins.

## Wireless Transfer

Access wireless networks and connect to computers, smartphones, or tablets. For more information, visit:  
<http://fujifilm-dsc.com/wifi/>



### Smart Phones and Tablets: FUJIFILM Camera Remote

Install the latest version of the FUJIFILM Camera Remote app on your smartphone or tablet to connect to the camera via Bluetooth® or Wi-Fi. For downloads and other information, visit:  
[http://app.fujifilm-dsc.com/en/camera\\_remote/](http://app.fujifilm-dsc.com/en/camera_remote/)

## Smart Phones and Tablets: Bluetooth® Pairing

Use  **CONNECTION SETTING** > **Bluetooth SETTINGS** > **PAIRING REGISTRATION** to pair the camera with smartphones or tablets. Pairing offers a simple method for downloading photos from the camera.



 Photos are downloaded via a wireless connection.

## Smartphones and Tablets: Wi-Fi

Use the  **WIRELESS COMMUNICATION** options in the shooting menu or the playback menu to connect to a smartphone or tablet via Wi-Fi. Once connected, you can browse the images on the camera, download selected images, control the camera remotely, or copy location data to the camera.



## Computers: FUJIFILM PC AutoSave

Install the latest version of FUJIFILM PC AutoSave to your computer to upload pictures from the camera over wireless networks. For downloads and other information, visit:

[http://app.fujifilm-dsc.com/en/pc\\_autosave/](http://app.fujifilm-dsc.com/en/pc_autosave/)

## Computers: Wireless Connections

You can upload pictures from the camera using the  **PC AUTO SAVE** option in the playback menu.



 You can also upload pictures by pressing and holding the **Fn** button in playback mode.

## Connecting to Computers via USB

Connect the camera to a computer to download pictures.

### Windows (MyFinePix Studio)

Use MyFinePix Studio to copy pictures to your computer, where they can be stored, viewed, organized, and printed. MyFinePix Studio is available for download from the following website:

<http://fujifilm-dsc.com/mfs/>

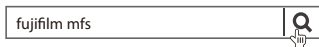

Once download is complete, double-click the downloaded file ("MFPS\_Setup.EXE") and follow the on-screen instructions to complete installation.

### Mac OS X/macOS

Pictures can be copied to your computer using Image Capture (supplied with your computer) or other software.

### RAW FILE CONVERTER EX 2.0

To view RAW files on your computer, use RAW FILE CONVERTER EX 2.0, available for download from:

<http://fujifilm-dsc.com/rfc/>



## Connecting the Camera

Connect the camera and computer using the supplied USB cable.

- 1 Find a memory card containing pictures you want to copy to the computer and insert the card into the camera.

**!** Loss of power during transfer could result in loss of data or damage to the memory card. Insert a fresh or fully-charged battery before connecting the camera.

- 2 Turn the camera off and connect the supplied USB cable as shown, making sure the connectors are fully inserted.

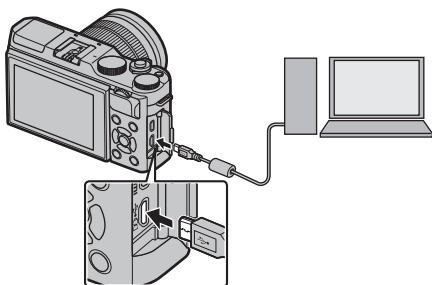

**!** The camera is equipped with a Micro USB (Micro-B) USB 2.0 connector.

- 3 Turn the camera on.
- 4 Copy pictures to the computer using MyFinePix Studio or applications provided with your operating system.
- 5 When transfer is complete, turn the camera off and disconnect the USB cable.



 If a memory card containing a large number of images is inserted, there may be a delay before the software starts and you may be unable to import or save images. Use a memory card reader to transfer pictures.

Connect the camera directly to the computer; do not use a USB hub or keyboard.

Do not disconnect the USB cable while data are being exchanged between the camera and computer or insert or remove memory cards while transfer is in progress. Failure to observe this precaution could result in loss of data or damage to the memory card.

In some cases, it may not be possible to access pictures saved to a network server using the software in the same way as on a standalone computer.

The user bears all applicable fees charged by the phone company or Internet service provider when using services that require an Internet connection.

## instax SHARE Printers

Print pictures from your digital camera to instax SHARE printers.

### Establishing a Connection

Select  **CONNECTION SETTING** > **instax PRINTER CONNECTION SETTING** in the camera setup menu and enter the instax SHARE printer name (SSID) and password.

#### The Printer Name (SSID) and Password

The printer name (SSID) can be found on the bottom of the printer; the default password is "1111". If you have already chosen a different password to print from a smartphone, enter that password instead.

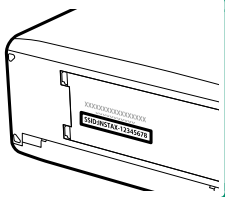

## Printing Pictures

- 1 Turn the printer on.
- 2 Select **instax PRINTER PRINT** in the camera playback menu. The camera will connect to the printer.



- 3 Use the selector to display the picture you want to print, then press **MENU/OK**.



 Pictures taken with other cameras cannot be printed.

The area printed is smaller than the area visible in the LCD monitor.

The displays may vary depending on the type of printer connected.

- 4 The picture will be sent to the printer and printing will start.



# 12

## Technical Notes

## Accessories from FUJIFILM

The following optional accessories are available from FUJIFILM. For the latest information on the accessories available in your region, check with your local FUJIFILM representative or visit [http://www.fujifilm.com/products/digital\\_cameras/index.html](http://www.fujifilm.com/products/digital_cameras/index.html).

### Rechargeable Li-ion batteries

**NP-W126/NP-W126S:** Additional high-capacity NP-W126/NP-W126S rechargeable batteries can be purchased as required.

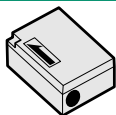

### Battery chargers

**BC-W126:** Replacement battery chargers can be purchased as required. At +20°C/+68°F, the BC-W126 charges an NP-W126/NP-W126S in about 150 minutes.

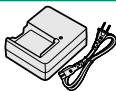

### AC power adapters

**AC-9V** (requires CP-W126 DC coupler): Use this 100–240 V, 50/60 Hz AC power adapter for extended shooting and playback or when copying pictures to a computer.

### DC couplers

**CP-W126:** Connect the AC-9V to the camera.

**Remote releases**

**RR-90:** Use to reduce camera shake or keep the shutter open during a time exposure.

**Stereo microphones**

**MIC-ST1:** An external microphone for movie recording.

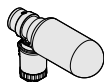
**FUJINON lenses**

**XF-series lenses:** Interchangeable lenses for use exclusively with the FUJIFILM X-mount.



**XC-series lenses:** Interchangeable lenses for use exclusively with the FUJIFILM X-mount.

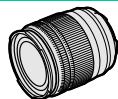

### Shoe-mounted flash units

**EF-X500:** This clip-on flash unit has a Guide Number of 50/164 (ISO 100, m/ft.) and is powered by four AA batteries or an optional EF-BP1 battery pack. The flash head can be rotated 90° up, 10° down, 135° left, or 180° right for bounce lighting.



**EF-42:** This clip-on flash unit (powered by four AA batteries) has a Guide Number of 42/137 (ISO 100, m/ft.) and supports manual and TTL flash control and auto power zoom in the range 24–105 mm (35 mm format equivalent). The flash head can be rotated 90° up, 180° left, or 120° right for bounce lighting.



**EF-X20:** This clip-on flash unit has a Guide Number of 20/65 (ISO 100, m/ft.). Powered by two AAA batteries, this light, compact unit features a dial for adjusting TTL flash compensation or manual flash output.

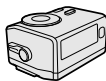

**EF-20:** This clip-on flash unit (powered by two AA batteries) has a Guide Number of 20/65 (ISO 100, m/ft.) and supports TTL flash control (manual flash control is not supported). The flash head can be rotated upwards 90° for bounce lighting.





**Grip belts**

**GB-001:** Offers an enhanced grip.

**Macro extension tubes**

**MCEX-11/16:** Attach between the camera and the lens to shoot at high reproduction ratios.

**Teleconverters**

**XF1.4X TC WR:** Increases the focal length of the compatible lenses by about 1.4x.

**XF2X TC WR:** Increases the focal length of the compatible lenses by about 2.0x.

**Mount adapters**

**FUJIFILM M MOUNT ADAPTER:** Allows the camera to be used with a wide selection of M-mount lenses.

**Body caps**

**BCP-001:** Cover the camera lens mount when no lens is attached.

**instax SHARE printers**

**SP-1/SP-2/SP-3:** Connect via wireless LAN to print pictures on instax film.

## Software from FUJIFILM

The camera can be used with the following FUJIFILM software.

### FUJIFILM Camera Remote

Establish a wireless connection between your camera and a smartphone or tablet (📖 172).

[http://app.fujifilm-dsc.com/en/camera\\_remote/](http://app.fujifilm-dsc.com/en/camera_remote/)

### FUJIFILM PC AutoSave

Download pictures from your camera over wireless networks (📖 174).

[http://app.fujifilm-dsc.com/en/pc\\_autosave/](http://app.fujifilm-dsc.com/en/pc_autosave/)

### MyFinePix Studio

Manage, view, print, and edit the many images downloaded from your digital camera (📖 175).

<http://fujifilm-dsc.com/mfs/>



### RAW FILE CONVERTER EX 2.0

View RAW pictures on your computer and convert them into other formats (📖 175).

<http://fujifilm-dsc.com/rfc/>



# For Your Safety

## IMPORTANT SAFETY INSTRUCTIONS

- **Read Instructions:** All the safety and operating instructions should be read before the appliance is operated.
- **Retain Instructions:** The safety and operating instructions should be retained for future reference.
- **Heed Warnings:** All warnings on the appliance and in the operating instructions should be adhered to.
- **Follow Instructions:** All operating and use instructions should be followed.

### Installation

**Power Sources:** This video product should be operated only from the type of power source indicated on the marking label. If you are not sure of the type of power supply to your home, consult your appliance dealer or local power company. For video products intended to operate from battery power, or other sources, refer to the operating instructions.

**Grounding or Polarization:** This video product is equipped with a polarized alternating-current line plug (a plug having one blade wider than the other). This plug will fit into the power outlet only one way. This is a safety feature. If you are unable to insert the plug fully into the outlet, try reversing the plug. If the plug should still fail to fit, contact your electrician to replace your obsolete outlet. Do not defeat the safety purpose of the polarized plug.

**Alternate Warnings:** This video product is equipped with a three-wire grounding-type plug, a plug having a third (grounding) pin. This plug will only fit into a grounding-type power outlet. This is a safety feature. If you are unable to insert the plug into the outlet, contact your electrician to replace your obsolete outlet. Do not defeat the safety purpose of the grounding type plug.

**Overloading:** Do not overload wall outlets and extension cords as this can result in a risk of fire or electric shock.

**Ventilation:** Slots and openings in the cabinet are provided for ventilation, to ensure reliable operation of the video product and to protect it from overheating, and these openings must not be blocked or covered. The openings should never be blocked by placing the video product on a bed, sofa, rug, or other similar surface.

This video product should not be placed in a built-in installation such as a bookcase or rack unless proper ventilation is provided or the manufacturer's instructions have been adhered to. This video product should never be placed near or over a radiator or heat register.

**Attachments:** Do not use attachments not recommended by the video product manufacturer as they may cause hazards.

**Water and Moisture:** Do not use this video product near water—for example, near a bath tub, wash bowl, kitchen sink, or laundry tub, in a wet basement, or near a swimming pool, and the like.

**Power-Cord Protection:** Power-supply cords should be routed so that they are not likely to be walked on or pinched by items placed upon or against them, paying particular attention to cords at plugs, convenience receptacles, and the point where they exit from the appliance.

**Accessories:** Do not place this video product on an unstable cart, stand, tripod, bracket, or table. The video product may fall, causing serious injury to a child or adult, and serious damage to the appliance. Use only with a cart, stand, tripod, bracket, or table recommended by the manufacturer, or sold with the video product. Any mounting of the appliance should follow the manufacturer's instructions, and should use a mounting accessory recommended by the manufacturer.

An appliance and cart combination should be moved with care. Quick stops, excessive force, and uneven surfaces may cause the appliance and cart combination to overturn.



### Antennas

**Outdoor Antenna Grounding:** If an outside antenna or cable system is connected to the video product, be sure the antenna or cable system is grounded so as to provide some protection against voltage surges and built-up static charges. Section 810 of the National Electrical Code, ANSI/NFPA No. 70, provides information with respect to proper grounding of the mast and supporting structure, grounding of the lead-in wire to an antenna discharge unit, size of grounding conductors, location of antenna discharge unit, connection to grounding electrodes, and requirements for the grounding electrode.

#### EXAMPLE OF ANTENNA GROUNDING AS PER NATIONAL ELECTRICAL CODE

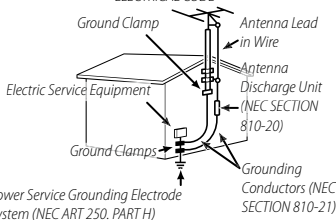

**Power Lines:** An outside antenna system should not be located in the vicinity of overhead power lines or other electric light or power circuits, or where it can fall into such power lines or circuits. When installing an outside antenna system, extreme care should be taken to keep from touching such power lines or circuits as contact with them might be fatal.

#### Use

**Cleaning:** Unplug this video product from the wall outlet before cleaning. Do not use liquid cleaners or aerosol cleaners. Use a damp cloth for cleaning.

**Object and Liquid Entry:** Never push objects of any kind into this video product through openings as they may touch dangerous voltage points or short out parts that could result in a fire or electric shock. Never spill liquid of any kind on the video product.

**Lightning:** For added protection for this video product receiver during a lightning storm, or when it is left unattended and unused for long periods of time, unplug it from the wall outlet and disconnect the antenna or cable system. This will prevent damage to the video product due to lightning and power-line surges.

#### Service

**Servicing:** Do not attempt to service this video product yourself as opening or removing covers may expose you to dangerous voltage or other hazards. Refer all servicing to qualified service personnel.

**Damage Requiring Service:** Unplug this video product from the wall outlet and refer servicing to qualified service personnel under the following conditions:

- When the power-supply cord or plug is damaged
- If liquid has been spilled, or objects have fallen into the video product.
- If the video product has been exposed to rain or water.
- If the video product has been dropped or the cabinet has been damaged.

If the video product does not operate normally follow the operating instructions. Adjust only those controls that are covered by the operating instructions as an improper adjustment of other controls may result in damage and will often require extensive work by a qualified technician to restore the video product to its normal operation.

When the video product exhibits a distinct change in performance — this indicates a need for service.

**Replacement Parts:** When replacement parts are required, be sure the service technician has used replacement parts specified by the manufacturer or have the same characteristics as the original part. Unauthorized substitutions may result in fire, electric shock or other hazards.

**Safety Check:** Upon completion of any service or repairs to this video product, ask the service technician to perform safety checks to determine that the video product is in proper operating condition.



## Be sure to read these notes before use

### Safety Notes



- Make sure that you use your camera correctly. Read these safety notes and your *Owner's Manual* carefully before use.
- After reading these safety notes, store them in a safe place.

### About the Icons



The icons shown below are used in this document to indicate the severity of the injury or damage that can result if the information indicated by the icon is ignored and the product is used incorrectly as a result.

	<b>WARNING</b>	This icon indicates that death or serious injury can result if the information is ignored.
	<b>CAUTION</b>	This icon indicates that personal injury or material damage can result if the information is ignored.

The icons shown below are used to indicate the nature of the instructions which are to be observed.

	Triangular icons tell you that this information requires attention ("Important").
	Circular icons with a diagonal bar tell you that the action indicated is prohibited ("Prohibited").
	Filled circles with an exclamation mark indicate an action that must be performed ("Required").

The symbols on the product (including the accessories) represent the following:

	AC
	DC
	Class II equipment (The construction of the product is double-insulated.)

### WARNING

**If a problem arises, turn the camera off, remove the battery, and disconnect and unplug the AC power adapter.**



Continued use of the camera when it is emitting smoke, is emitting any unusual odor, or is in any other abnormal state can cause a fire or electric shock. Contact your FUJIFILM dealer.













**Do not allow water or foreign objects to enter the camera.**

















If water or foreign objects get inside the camera, turn the camera off, remove the battery, and disconnect and unplug the AC power adapter. Continued use of the camera can cause a fire or electric shock. Contact your FUJIFILM dealer.



**Do not use the camera in the bathroom or shower.** This can cause a fire or electric shock.

 <b>WARNING</b>	
	<b>Never attempt to change or take apart the camera (never open the case).</b> Failure to observe this precaution can cause fire or electric shock.
	<b>Should the case break open as the result of a fall or other accident, do not touch the exposed parts.</b> Failure to observe this precaution could result in electric shock or in injury from touching the damaged parts. Remove the battery immediately, taking care to avoid injury or electric shock, and take the product to the point of purchase for consultation.
	<b>Do not change, heat or unduly twist or pull the connection cord and do not place heavy objects on the connection cord.</b> These actions could damage the cord and cause a fire or electric shock. If the cord is damaged, contact your FUJIFILM dealer.
	<b>Do not place the camera on an unstable surface.</b> This can cause the camera to fall or tip over and cause injury.
	<b>Never attempt to take pictures while in motion.</b> Do not use the camera while walking or driving. This can result in you falling down or being involved in a traffic accident.
	<b>Do not touch any metal parts of the camera during a thunderstorm.</b> This can cause an electric shock due to induced current from the lightning discharge.
	<b>Do not use the battery except as specified.</b> Load the battery as shown by the indicator.
	<b>Do not disassemble, modify, or heat batteries. Do not drop, strike, or throw batteries or otherwise subject them to strong impacts. Do not use batteries that show signs of leaking, deformation, discoloration, or other abnormalities. Use only designated chargers to recharge rechargeable batteries and do not attempt to recharge non-rechargeable Li-ion or alkaline batteries. Do not short batteries or store them with metallic objects.</b> Failure to observe these precautions could result in the batteries overheating, igniting, rupturing, or leaking, causing fire, burns, or other injury.
	<b>Use only batteries or AC power adapters specified for use with this camera. Do not use voltages other than the power supply voltage shown.</b> The use of other power sources can cause a fire.
	<b>If the battery leaks and fluid gets in contact with your eyes, skin or clothing, flush the affected area with clean water and seek medical attention or call an emergency number right away.</b>
	<b>Do not use the charger to charge batteries other than those specified here.</b> The supplied charger is for use only with batteries of the type supplied with the camera. Using the charger to charge conventional batteries or other types of rechargeable batteries can cause the battery to leak, overheat or burst.

 <b>WARNING</b>	
	<b>Using a flash too close to a person's eyes may cause visual impairment.</b> Take particular care when photographing infants and young children.
	<b>Do not remain in prolonged contact with hot surfaces.</b> Failure to observe this precaution could result in low-temperature burns, particularly at high ambient temperatures or with users who suffer from poor circulation or reduced sensation, in which case use of a tripod or similar precautions are recommended.
	<b>Do not leave one part of the body in contact with the product for prolonged periods while the product is on.</b> Failure to observe this precaution could result in low-temperature burns, particularly during prolonged use, at high ambient temperatures, or with users who suffer from poor circulation or reduced sensation, in which case use of a tripod or similar precautions are recommended.
	<b>Do not use in the presence of flammable objects, explosive gases, or dust.</b>
	<b>When carrying the battery, install it in a digital camera or keep it in the hard case. When storing the battery, keep it in the hard case. When discarding, cover the battery terminals with insulation tape.</b> Contact with other metallic objects or batteries could cause the battery to ignite or burst.
	<b>Keep memory cards, hot shoes, and other small parts out of the reach of small children.</b> Children may swallow small parts; keep out of reach of children. Should a child swallow a small part, seek medical attention or call emergency.
	<b>Keep out of reach of small children.</b> Among the elements that could cause injury are the strap, which could become entangled about a child's neck, causing strangulation, and the flash, which could cause visual impairment.
	<b>Follow the directions of airline and hospital personnel.</b> This product generates radio-frequency emissions that could interfere with navigational or medical equipment.
 <b>CAUTION</b>	
	<b>Do not use this camera in locations affected by oil fumes, steam, humidity or dust.</b> This can cause a fire or electric shock.
	<b>Do not leave this camera in places subject to extremely high temperatures.</b> Do not leave the camera in locations such as a sealed vehicle or in direct sunlight. This can cause a fire.
	<b>Do not place heavy objects on the camera.</b> This can cause the heavy object to tip over or fall and cause injury.
	<b>Do not move the camera while the AC power adapter is still connected.</b> Do not pull on the connection cord to disconnect the AC power adapter. This can damage the power cord or cables and cause a fire or electric shock.

**CAUTION**

**Do not cover or wrap the camera or the AC power adapter in a cloth or blanket.** This can cause heat to build up and distort the casing or cause a fire.



**When you are cleaning the camera or you do not plan to use the camera for an extended period, remove the battery and disconnect and unplug the AC power adapter.** Failure to do so can cause a fire or electric shock.



**When charging ends, unplug the charger from the power socket.** Leaving the charger plugged into the power socket can cause a fire.

**CAUTION**

**When a memory card is removed, the card could come out of the slot too quickly. Use your finger to hold it and gently release the card.** Injury could result to those struck by the ejected card.



**Request regular internal testing and cleaning for your camera.** Build-up of dust in your camera can cause a fire or electric shock. Contact your FUJIFILM dealer to request internal cleaning every two years. Please note that this service is not free of charge.



**Danger of explosion if battery is incorrectly replaced. Replace only with the same or equivalent type.**

**The Battery and Power Supply**

**Note:** Check the type of battery used in your camera and read the appropriate sections.

**WARNING** Battery shall not be exposed to excessive heat such as sunshine, fire or the like.

The following describes the proper use of batteries and how to prolong their life. Incorrect use can shorten battery life or cause leakage, overheating, fire, or explosion.

**Li-ion Batteries**

Read this section if your camera uses a rechargeable Li-ion battery.

The battery is not charged at shipment. Charge the battery before use. Keep the battery in its case when not in use.

**Notes on the Battery**

The battery gradually loses its charge when not in use. Charge the battery one or two days before use.

Battery life can be extended by turning the camera off when not in use.

Battery capacity decreases at low temperatures; a depleted battery may not function when cold. Keep a fully charged spare battery in a warm place and exchange as necessary, or keep the battery in your pocket or other warm place and insert it in the camera only when shooting. Do not place the battery in direct contact with hand warmers or other heating devices.

**Charging the Battery**

Charge the battery in the supplied battery charger. Charging times will increase at ambient temperatures below +10°C (+50°F) or above +35°C (+95°F). Do not attempt to charge the battery at temperatures above +40°C (+104°F); at temperatures below 0°C (+32°F), the battery will not charge.

Do not attempt to recharge a fully charged battery. The battery does not however need to be fully discharged before charging.

The battery may be warm to the touch immediately after charging or use. This is normal.

**Battery Life**

At normal temperatures, the battery can be recharged about 300 times. A noticeable decrease in the length of time the battery will hold a charge indicates that it has reached the end of its service life and should be replaced.

**Storage**

Performance may be impaired if the battery is left unused for extended periods when fully charged. Run the battery flat before storing it.

If the camera will not be used for an extended period, remove the battery and store it in a dry place with an ambient temperature of from +15°C to +25°C (+59°F to +77°F). Do not store in locations exposed to extremes of temperature.

**Cautions: Handling the Battery**

- Do not transport or store with metal objects such as necklaces or hairpins.
- Do not expose to flame or heat.
- Do not disassemble or modify.
- Use with designated chargers only.
- Dispose of used batteries promptly.
- Do not drop or subject to strong physical shocks.
- Do not expose to water.
- Keep the terminals clean.
- The battery and camera body may become warm to the touch after extended use. This is normal.

**Caution: Disposal**

Dispose of used batteries in accord with local regulations. Attention should be drawn to the environmental aspects of battery disposal. Use the apparatus under moderate climate.

**AC Power Adapters (Available Separately)**

Use only FUJIFILM AC power adapters designated for use with this camera. Other adapters could damage the camera.

- The AC power adapter is for indoor use only.
- Be sure the DC plug is securely connected to the camera.
- Turn the camera off before disconnecting the adapter. Disconnect the adapter by the plug, not the cable.
- Do not use with other devices.
- Do not disassemble.
- Do not expose to high heat and humidity.
- Do not subject to strong physical shocks.
- The adapter may hum or become hot to the touch during use. This is normal.
- If the adapter causes radio interference, reorient or relocate the receiving antenna.

## Using the Camera

- Do not aim the camera at extremely bright light sources, such as the sun in a cloudless sky. Failure to observe this precaution could damage the camera image sensor.
- Strong sunlight focused through the viewfinder may damage the panel of electronic viewfinder (EVF). Do not aim the electronic viewfinder at the sun.

### **Take Test Shots**

Before taking photographs on important occasions (such as at weddings or before taking the camera on a trip), take a test shot and view the results to ensure that the camera is functioning normally. FUJIFILM Corporation cannot accept liability for damages or lost profits incurred as a result of product malfunction.

### **Notes on Copyright**

Unless intended solely for personal use, images recorded using your digital camera system cannot be used in ways that infringe copyright laws without the consent of the owner. Note that some restrictions apply to the photographing of stage performances, entertainments, and exhibits, even when intended purely for personal use. Users are also asked to note that the transfer of memory cards containing images or data protected under copyright laws is only permissible within the restrictions imposed by those copyright laws.

### **Handling**

To ensure that images are recorded correctly, do not subject the camera to impact or physical shocks while images are being recorded.

### **Liquid Crystal**

In the event that the display is damaged, care should be taken to avoid contact with liquid crystal. Take the urgent action indicated should any of the following situations arise:

- **If liquid crystal comes in contact with your skin**, clean the area with a cloth and then wash thoroughly with soap and running water.
- **If liquid crystal enters your eyes**, flush the affected eye with clean water for at least 15 minutes and then seek medical assistance.
- **If liquid crystal is swallowed**, rinse your mouth thoroughly with water. Drink large quantities of water and induce vomiting, then seek medical assistance.

Although the display is manufactured using extremely high-precision technology, it may contain pixels that are always lit or that do not light. This is not a malfunction, and images recorded with the product are unaffected.

### **Trademark Information**

Digital Split Image is a trademark or registered trademark of FUJIFILM Corporation. xD-Picture Card and  are trademarks of FUJIFILM Corporation. The typefaces included herein are solely developed by DynaComware Taiwan Inc. Macintosh, Mac OS, and macOS are trademarks of Apple Inc. in the U.S.A. and other countries. Windows is a registered trademark of Microsoft Corporation in the U.S.A. and other countries. Wi-Fi® and Wi-Fi Protected Setup® are registered trademarks of the Wi-Fi Alliance. The Bluetooth® word mark and logos are registered trademarks owned by the Bluetooth SIG, Inc., and any use of such marks by FUJIFILM is under license. The SDHC and SDXC logos are trademarks of SD-3C, LLC. The HDMI logo is a trademark or registered trademark of HDMI Licensing LLC. All other trade names mentioned in this manual are the trademarks or registered trademarks of their respective owners.

### **Electrical Interference**

This camera may interfere with hospital or aviation equipment. Consult with hospital or airline staff before using the camera in a hospital or on an aircraft.

### **Color Television Systems**

NTSC (National Television System Committee) is a color television telecasting specification adopted mainly in the U.S.A., Canada, and Japan. PAL (Phase Alternation by Line) is a color television system adopted mainly in European countries and China.

### **Exif Print (Exif Version 2.3)**

Exif Print is a newly revised digital camera file format in which information stored with photographs is used for optimal color reproduction during printing.

### **IMPORTANT NOTICE: Read Before Using the Software**

Direct or indirect export, in whole or in part, of licensed software without the permission of the applicable governing bodies is prohibited.

## NOTICES

To prevent fire or shock hazard, do not expose the unit to rain or moisture.

Please read the "Safety Notes" and make sure you understand them before using the camera.

Perchlorate Material—special handling may apply. See:

<http://www.dtscc.ca.gov/hazardouswaste/perchlorate>

For Customers in the U.S.A.

### Tested To Comply With FCC Standards FOR HOME OR OFFICE USE



Contains IC : 7736B-02100005

Contains FCC ID : W22-02100005

**FCC Statement:** This device complies with Part 15 of the FCC Rules. Operation is subject to the following two conditions: (1) This device may not cause harmful interference, and (2) this device must accept any interference received, including interference that may cause undesired operation.

**CAUTION:** This equipment has been tested and found to comply with the limits for a Class B digital device, pursuant to Part 15 of the FCC Rules. These limits are designed to provide reasonable protection against harmful interference in a residential installation. This equipment generates, uses, and can radiate radio frequency energy and, if not installed and used in accordance with the instructions, may cause harmful interference to radio communications. However, there is no guarantee that interference will not occur in a particular installation. If this equipment does cause harmful interference to radio or television reception, which can be determined by turning the equipment off and on, the user is encouraged to try to correct the interference by one or more of the following measures:

- Reorient or relocate the receiving antenna.
- Increase the separation between the equipment and receiver.
- Connect the equipment into an outlet on a circuit different from that to which the receiver is connected.
- Consult the dealer or an experienced radio/TV technician for help.

**FCC Caution:** Any changes or modifications not expressly approved by the party responsible for compliance could void the user's authority to operate this equipment.

This transmitter must not be co-located or operating in conjunction with any other antenna or transmitter.

**Radiation Exposure Statement:** This device meets the government's requirements for exposure to radio waves. This device is designed and manufactured not to exceed the emission limits for exposure to radio frequency (RF) energy set by the Federal Communications Commission of the U.S. Government.

The exposure standard for wireless device employs a unit of measurement known as the Specific Absorption Rate, or SAR. The SAR limit set by the FCC is 1.6W/kg. Tests for SAR are conducted using standard operating positions accepted by the FCC with the device transmitting at its highest certified power level in all tested frequency bands.

**Notes on the Grant:** To comply with Part 15 of the FCC Rules, this product must be used with a Fujifilm-specified ferrite-core A/V cable, USB cable, and DC supply cord.



A lithium ion battery that is recyclable powers the product you have purchased. Please call 1-800-8-BATTERY for information on how to recycle this battery.



**For Customers in Canada****CAN ICES-3 (B)/NMB-3(B)**

**CAUTION:** This Class B digital apparatus complies with Canadian ICES-003.

**Industry Canada statement:** This device complies with Industry Canada's licence-exempt RSSs. Operation is subject to the following two conditions: (1) This device may not cause interference; and (2) This device must accept any interference, including interference that may cause undesired operation of the device.

This device and its antenna(s) must not be co-located or operating in conjunction with any other antenna or transmitter, except tested built-in radios. The County Code Selection feature is disabled for products marketed in the US/ Canada.

**Radiation Exposure Statement:** The available scientific evidence does not show that any health problems are associated with using low power wireless devices. There is no proof, however, that these low power wireless devices are absolutely safe. Low power Wireless devices emit low levels of radio frequency energy (RF) in the microwave range while being used. Whereas high levels of RF can produce health effects (by heating tissue), exposure of low-level RF that does not produce heating effects causes no known adverse health effects. Many studies of low-level RF exposures have not found any biological effects. Some studies have suggested that some biological effects might occur, but such findings have not been confirmed by additional research. X-A5 has been tested and found to comply with IC radiation exposure limits set forth for an uncontrolled environment and meets RSS-102 of the IC radio frequency (RF) Exposure rules.

**Disposal of Electrical and Electronic Equipment in Private Households****In the European Union, Norway, Iceland and Liechtenstein:**

This symbol on the product, or in the manual and in the warranty, and/or on its packaging indicates that this product shall not be treated as household waste. Instead it should be taken to an applicable collection point for the recycling of electrical and electronic equipment.

By ensuring this product is disposed of correctly, you will help prevent potential negative consequences to the environment and human health, which could otherwise be caused by inappropriate waste handling of this product.

This symbol on the batteries or accumulators indicates that those batteries shall not be treated as household waste.

If your equipment contains easy removable batteries or accumulators please dispose these separately according to your local requirements.

The recycling of materials will help to conserve natural resources. For more detailed information about recycling this product, please contact your local city office, your household waste disposal service or the shop where you purchased the product.

**In Countries Outside the European Union, Norway, Iceland and Liechtenstein:**

If you wish to discard this product, including the batteries or accumulators, please contact your local authorities and ask for the correct way of disposal.

**In Japan:** This symbol on the batteries indicates that they are to be disposed of separately.



## Wireless Network and Bluetooth Devices: Cautions

This product complies with the following EU Directives:

- RoHS Directive 2011/65/EU
- RE Directive 2014/53/EU

Hereby, FUJIFILM Corporation declares that the radio equipment type FF170003 is in compliance with Directive 2014/53/EU.

The full text of the EU declaration of conformity is available at the following internet address: [http://www.fujifilm.com/products/digital\\_cameras/x/fujifilm\\_x\\_a5/pdf/index/fujifilm\\_x\\_a5\\_cod.pdf](http://www.fujifilm.com/products/digital_cameras/x/fujifilm_x_a5/pdf/index/fujifilm_x_a5_cod.pdf)

This compliance is indicated by the following conformity marking placed on the product:



This marking is valid for non-Telecom products and EU harmonized Telecom products (e.g. Bluetooth®).

**IMPORTANT:** Read the following notices before using the camera's built-in wireless transmitter.

Ⓢ This product, which contains encryption function developed in the United States, is controlled by the United States Export Administration Regulations and may not be exported or re-exported to any country to which the United States embargoes goods.

- **Use only a wireless network or Bluetooth device.** FUJIFILM does not accept liability for damages resulting from unauthorized use. Do not use in applications requiring a high degree of reliability, for example in medical devices or other systems that may directly or indirectly impact human life. When using the device in computer and other systems that demand a greater degree of reliability than offered by wireless network or Bluetooth devices, be sure to take all necessary precautions to ensure safety and prevent malfunction.
- **Use only in the country in which the device was purchased.** This device conforms to regulations governing wireless network and Bluetooth devices in the country in which it was purchased. Observe all location regulations when using the device. FUJIFILM does not accept liability for problems arising from use in other jurisdictions.
- **Do not use the device in locations subject to magnetic fields, static electricity, or radio interference.** Do not use the transmitter in the vicinity of microwave ovens or in other locations subject to magnetic fields, static electricity, or radio interference that may prevent reception of wireless signals. Mutual interference may occur when the transmitter is used in the vicinity of other wireless devices operating in the 2.4 GHz band.

- **The wireless transmitter operates in the 2.4 GHz band using DSSS, OFDM and GFSK modulation.**

• **Security:** Wireless network and Bluetooth devices transmit data via radio and consequently their use requires greater attention to security than applies in the case of wired networks.

- Do not connect to unknown networks or networks to which you do not have access rights, even if they are displayed on your device, as such access may be considered unauthorized. Connect only to networks to which you have access rights.
- Be aware that wireless transmissions may be vulnerable to interception by third parties.

- **The following may be punishable by law:**

- Disassembly or modification of this device
- Removal of device certification labels

- **This device operates on the same frequency as commercial, educational, and medical devices and wireless transmitters.**

It also operates on the same frequency as licensed transmitters and special unlicensed low-voltage transmitters used in RFID tracking systems for assembly lines and in other similar applications.

- **To prevent interference with the above devices, observe the following precautions.**

Confirm that the RFID transmitter is not in operation before using this device. Should you observe that the device causes interference in licensed transmitters used for RFID tracking, immediately stop using the affected frequency or move the device to another location. If you notice that this device causes interference in low-voltage RFID tracing systems, contact a FUJIFILM representative.

- **Do not use this device on board an aircraft.** Note that Bluetooth may remain on even when the camera is off. Bluetooth can be disabled by selecting **OFF** for  **CONNECTION SETTING > Bluetooth SETTINGS > Bluetooth ON/OFF.**



## Be sure to read these notes before using the lens

## Safety Notes



- Make sure that you use the lens correctly. Read these safety notes and the camera *Owner's Manual* carefully before use.
- After reading these safety notes, store them in a safe place.

## About the Icons

The icons shown below are used in this document to indicate the severity of the injury or damage that can result if the information indicated by the icon is ignored and the product is used incorrectly as a result.

	<b>WARNING</b> This icon indicates that death or serious injury can result if the information is ignored.
	<b>CAUTION</b> This icon indicates that personal injury or material damage can result if the information is ignored.

The icons shown below are used to indicate the nature of the instructions which are to be observed.

	Triangular icons tell you that this information requires attention ("Important").
	Circular icons with a diagonal bar tell you that the action indicated is prohibited ("Prohibited").
	Filled circles with an exclamation mark indicate an action that must be performed ("Required").

 **WARNING**

 **Do not immerse in or expose to water.** Failure to observe this precaution can cause a fire or electric shock.

 **Do not disassemble (do not open the case).** Failure to observe this precaution can cause fire, electric shock, or injury due to product malfunction.

 **Should the case break open as the result of a fall or other accident, do not touch the exposed parts.** Failure to observe this precaution could result in electric shock or in injury from touching the damaged parts. Remove the battery immediately, taking care to avoid injury or electric shock, and take the product to the point of purchase for consultation.

 **Do not place on unstable surfaces.** The product may fall, causing injury.

 **Do not view the sun through the lens or camera viewfinders.** Failure to observe this precaution can cause permanent visual impairment.

 **CAUTION**

 **Do not use or store in locations that are exposed to steam, or smoke or are very humid or extremely dusty.** Failure to observe this precaution can cause fire or electric shock.

 **Do not leave in direct sunlight or in locations subject to very high temperatures, such as in a closed vehicle on a sunny day.** Failure to observe this precaution can cause fire.

 **Keep out of the reach of small children.** This product could cause injury in the hands of a child.

 **Do not handle with wet hands.** Failure to observe this precaution can cause electric shock.

 **Keep the sun out of the frame when shooting backlit subjects.** Sunlight focused into the camera when the sun is in or close to the frame can cause fire or burns.

 **When the product is not in use, replace the lens caps and store out of direct sunlight.** Sunlight focused by the lens can cause fire or burns.

 **Do not carry the camera or lens while they are attached to a tripod.** The product can fall or strike other objects, causing injury.

## Product Care

---

To ensure continued enjoyment of the product, observe the following precautions.

---

**Camera body:** Use a soft, dry cloth to clean the camera body after each use. Do not use alcohol, thinner, or other volatile chemicals, which could discolor or deform the leather on the camera body. Any liquid on the camera should be removed immediately with a soft, dry cloth. Use a blower to remove dust from the monitor, taking care to avoid scratches, and then gently wipe with a soft, dry cloth. Any remaining stains can be removed by wiping gently with a piece of FUJIFILM lens-cleaning paper to which a small amount of lens-cleaning fluid has been applied. To prevent dust entering the camera, replace the body cap when no lens is in place.

**Image sensor:** Multiple photographs marred by spots or blotches in identical locations may indicate the presence of dust on the image sensor. Dust can be removed from the image sensor using the  **SENSOR CLEANING** option in the setup menu.

## Cleaning the Image Sensor

Dust that cannot be removed using the  **SENSOR CLEANING** option in the setup menu can be removed manually as described below.

 Note that there will be a charge to repair or replace the image sensor if it is damaged during cleaning.

- 1 Use a blower (not a brush) to remove dust from the sensor.

 Do not use a brush or blower brush. Failure to observe this precaution could damage the sensor.

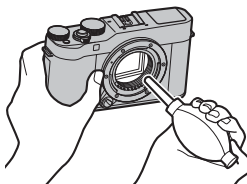

- 2 Check whether the dust has been successfully removed. Repeat Steps 1 and 2 as necessary.
- 3 Replace the body cap or lens.

## Firmware Updates

Updates to product firmware may result in changes not described in the manual. For more information, visit:  
[http://www.fujifilm.com/support/digital\\_cameras/software](http://www.fujifilm.com/support/digital_cameras/software)



### Checking the Firmware Version

 The camera will only display the firmware version if a memory card is inserted.

- 1 Turn the camera off and check that a memory card is inserted.
- 2 Turn the camera on while holding the **DISP/BACK** button. The current firmware version will be displayed; check the firmware version.
- 3 Turn the camera off.

 To view the firmware version or update firmware for optional accessories such as interchangeable lenses, shoe-mounted flash units, and mount adapters, mount the accessories on the camera.

## Troubleshooting

Consult the table below should you encounter problems using your camera. If you don't find the solution here, contact your local FUJIFILM distributor.

### Power and Battery

Problem	Solution
The camera does not turn on.	<ul style="list-style-type: none"><li>• <b>The battery is exhausted:</b> Charge the battery or insert a fully-charged spare battery (📖 26).</li><li>• <b>The battery is inserted incorrectly:</b> Reinsert in the correct orientation (📖 22).</li><li>• <b>The battery-chamber cover is not latched:</b> Latch the battery-chamber cover (📖 22).</li></ul>
The monitor does not turn on.	The monitor may not turn on if the camera is turned off and then on again very quickly. Press the shutter button halfway to activate the monitor.
The battery runs down quickly.	<ul style="list-style-type: none"><li>• <b>The battery is cold:</b> Warm the battery by placing it in a pocket or other warm place and reinsert it in the camera immediately before taking a picture.</li><li>• <b>There is dirt on the battery terminals:</b> Clean the terminals with a soft, dry cloth.</li><li>• <b>ON is selected for PRE-AF:</b> Turn <b>PRE-AF</b> off (📖 101).</li><li>• <b>The battery has been charged many times:</b> The battery has reached the end of its charging life. Purchase a new battery.</li></ul>
The camera turns off suddenly.	<b>The battery is exhausted:</b> Charge the battery or insert a fully-charged spare battery (📖 26).
Charging does not start.	Reinsert the battery in the correct orientation and make sure that the charger is plugged in (📖 22, 26).
Charging is slow.	Charge the battery at room temperature.

Problem	Solution
The charging lamp blinks, but the battery does not charge.	<ul style="list-style-type: none"> <li>• <b>There is dirt on the battery terminals:</b> Clean the terminals with a soft, dry cloth (📖 22).</li> <li>• <b>The battery has been charged many times:</b> The battery has reached the end of its charging life. Purchase a new battery. If the battery still fails to charge, contact your FUJIFILM dealer (📖 182).</li> </ul>

## Menus and Displays

Problem	Solution
Display is not in English.	Select <b>ENGLISH</b> for 言語/LANG. (📖 33, 142).

## Shooting

Problem	Solution
No picture is taken when the shutter button is pressed.	<ul style="list-style-type: none"> <li>• <b>The memory card is full:</b> Insert a new memory card or delete pictures (📖 22, 132).</li> <li>• <b>The memory card is not formatted:</b> Format the memory card (📖 155).</li> <li>• <b>There is dirt on the memory card contacts:</b> Clean the contacts with a soft, dry cloth.</li> <li>• <b>The memory card is damaged:</b> Insert a new memory card (📖 22).</li> <li>• <b>The battery is exhausted:</b> Charge the battery or insert a fully-charged spare battery (📖 26).</li> <li>• <b>The camera has turned off automatically:</b> Turn the camera on (📖 29).</li> <li>• <b>You are using a third-party mount adapter:</b> Select <b>ON</b> for <b>SHOOT WITHOUT LENS</b> (📖 115).</li> <li>• <b>The indicator lamp was orange when you attempted to record a panorama:</b> Wait until the indicator lamps turns off (📖 56).</li> </ul>
Mottling (“noise”) appears in the monitor when the shutter button is pressed halfway.	Gain is increased to aid composition when the subject is poorly lit and aperture is stopped down, which may result in noticeable mottling when images are previewed in the displays. Images taken with the camera are unaffected.



Problem	Solution
The camera does not focus.	<p><b>The subject is not suited to autofocus:</b> Use focus lock or manual focus (📖 76).</p>
No face is detected.	<ul style="list-style-type: none"> <li>• <b>The subject's face is obscured by sunglasses, a hat, long hair, or other objects:</b> Remove the obstructions (📖 100).</li> <li>• <b>The subject's face occupies only a small area of the frame:</b> Change the composition so that the subject's face occupies a larger area of the frame (📖 100).</li> <li>• <b>The subject's head is tilted or horizontal:</b> Ask the subject to hold their head straight (📖 100).</li> <li>• <b>The camera is tilted:</b> Keep the camera level.</li> <li>• <b>The subject's face is poorly lit:</b> Shoot in bright light.</li> </ul>
Wrong subject is selected.	<p>The selected subject is closer to the center of the frame than the main subject. Recompose the picture or turn face detection off and frame the picture using focus lock (📖 76).</p>
Movie recording, 4K burst, and 4K multi-focus are unavailable.	<p><b>The memory card write speed is too slow:</b> Use a memory card with a UHS speed class of 3 or better (📖 25, 42, 90).</p>
The flash does not fire.	<ul style="list-style-type: none"> <li>• <b>The battery is exhausted:</b> Charge the battery or insert a fully-charged spare battery (📖 26).</li> <li>• <b>The camera is in bracketing or continuous mode:</b> Select single frame mode (📖 85, 88).</li> <li>• <b>OFF is selected for SOUND &amp; FLASH:</b> Select <b>ON</b> (📖 143).</li> </ul>
The flash does not fully light the subject.	<ul style="list-style-type: none"> <li>• <b>The subject is not in range of the flash:</b> Position the subject in range of the flash.</li> <li>• <b>The flash window is obstructed:</b> Hold the camera correctly.</li> <li>• <b>Shutter speed is faster than the sync speed:</b> Choose a slower shutter speed (📖 50, 53, 210).</li> </ul>
Pictures are blurred.	<ul style="list-style-type: none"> <li>• <b>The lens is dirty:</b> Clean the lens (📖 168).</li> <li>• <b>The lens is blocked:</b> Keep objects away from the lens (📖 36).</li> <li>• <b>!AF is displayed during shooting and the focus frame is displayed in red:</b> Check focus before shooting (📖 37).</li> </ul>

Problem	Solution
Pictures are mottled.	<ul style="list-style-type: none"> <li>• <b>Shutter speed is slow and the ambient temperature is high:</b> This is normal and does not indicate a malfunction.</li> <li>• <b>The camera has been used continuously at high temperatures or a temperature warning is displayed:</b> Turn the camera off and wait for it to cool down (📖 29, 207).</li> </ul>

## Playback

Problem	Solution
Pictures are grainy.	The pictures were taken with a different make or model of camera.
Playback zoom is unavailable.	The pictures were created using <b>RESIZE</b> or with a different make or model of camera.
No sound in movie playback.	<ul style="list-style-type: none"> <li>• <b>Playback volume is too low:</b> Adjust playback volume (📖 144).</li> <li>• <b>The microphone was obstructed:</b> Hold the camera correctly during recording.</li> <li>• <b>The speaker is obstructed:</b> Hold the camera correctly during playback.</li> <li>• <b>OFF is selected for SOUND &amp; FLASH:</b> Select <b>ON</b> (📖 143).</li> </ul>
Selected pictures are not deleted.	Some of the pictures selected for deletion are protected. Remove protection using the device with which it was originally applied (📖 135).
File numbering is unexpectedly reset.	The battery-chamber cover was opened while the camera was on. Turn the camera off before opening the battery-chamber cover (📖 150).

## Connections

Problem	Solution
The monitor is blank.	<b>The camera is connected to a TV:</b> Pictures will be displayed on the TV instead of in the camera monitor (📖 170).

Problem	Solution
No picture or sound on TV.	<ul style="list-style-type: none"> <li>• <b>The camera is not properly connected:</b> Connect the camera properly (📖 170).</li> <li>• <b>Input on the television is set to “TV”:</b> Set input to “HDMI” (📖 170).</li> <li>• <b>The volume on the TV is too low:</b> Use the controls on the television to adjust the volume (📖 170).</li> </ul>
The computer does not recognize the camera.	Be sure the camera and computer are correctly connected (📖 175).
Cannot transfer RAW or JPEG files to computer.	Use MyFinePix Studio to transfer pictures (Windows only; 📖 175).

## Wireless Transfer

For additional information on troubleshooting wireless connections, visit: <http://digital-cameras.support.fujifilm.com/app?pid=x>

Problem	Solution
Problem connecting or uploading pictures to smartphone.	<ul style="list-style-type: none"> <li>• <b>The smartphone is too far away:</b> Move the devices closer (📖 172).</li> <li>• <b>Nearby devices are causing radio interference:</b> Move the camera and smartphone away from microwave ovens or cordless phones (📖 172).</li> </ul>
Cannot upload images.	<ul style="list-style-type: none"> <li>• <b>The smartphone is connected to another device:</b> The smartphone and camera can connect to only one device at a time. End the connection and try again.</li> <li>• <b>There are several smartphones in the vicinity:</b> Try connecting again. The presence of multiple smartphones can make connection difficult.</li> <li>• <b>The image was created on another device:</b> The camera may not be able to upload images created on other devices.</li> <li>• <b>The image is a movie:</b> Uploading movies takes some time. Movies intended for display on a smartphone or tablet should be recorded at a frame size of 1280×720 (HD) or smaller. For information on viewing the pictures on the camera, visit: <a href="http://app.fujifilm-dsc.com/en/camera_remote/">http://app.fujifilm-dsc.com/en/camera_remote/</a></li> </ul>



Problem	Solution
Smartphone will not display pictures.	Select <b>ON</b> for <b>RESIZE IMAGE FOR SMARTPHONE</b> (3M). Selecting <b>OFF</b> increases upload times for larger images; in addition, some phones may not display images over a certain size (154).

## Miscellaneous





Problem	Solution
The camera is unresponsive.	<ul style="list-style-type: none"> <li>• <b>Temporary camera malfunction:</b> Remove and reinsert the battery (22).</li> <li>• <b>The battery is exhausted:</b> Charge the battery or insert a fully-charged spare battery (26).</li> <li>• <b>The camera is connected to a wireless LAN:</b> End the connection.</li> <li>• <b>The controls are locked:</b> Press and hold the <b>MENU/OK</b> button to unlock the controls (5).</li> </ul>
The camera does not function as expected.	Remove and reinsert the battery (22). If the problem persists, contact your FUJIFILM dealer.
No sound.	<ul style="list-style-type: none"> <li>• Adjust the volume (144).</li> <li>• Select <b>ON</b> for <b>SOUND &amp; FLASH</b> (143).</li> </ul>
Time and date stamps.	<ul style="list-style-type: none"> <li>• <b>Time and date stamps are not correct:</b> Set the camera clock (33, 142).</li> <li>• <b>Time and date stamps appear on photographs:</b> Time and date stamps cannot be deleted. To prevent stamps appearing on new photographs, select <b>OFF</b> for <b>SAVE DATA SET-UP &gt; DATE STAMP</b> (151).</li> </ul>

## Warning Messages and Displays

The following warnings appear in the display.



Warning	Description
 (red)	Low battery. Charge the battery or insert a fully-charged spare battery.
 (blinks red)	Battery exhausted. Charge the battery or insert a fully-charged spare battery.
<b>!AF</b> (displayed in red with red focus frame)	The camera cannot focus. Use focus lock to focus on another subject at the same distance, then recompose the picture.
Aperture or shutter speed displayed in red	The subject is too bright or too dark and the picture will be over- or under-exposed. Use the flash for additional lighting when taking photographs of poorly-lit subject.
<b>FOCUS ERROR</b> <b>LENS CONTROL ERROR</b> <b>TURN OFF THE CAMERA AND TURN ON AGAIN</b>	Camera malfunction. Turn the camera off and then on again. If the message persists, contact a FUJIFILM dealer.
<b>NO CARD</b>	The shutter can only be released when a memory card is inserted. Insert a memory card.
<b>CARD NOT INITIALIZED</b>	<ul style="list-style-type: none"><li>• <b>The memory card is not formatted or the memory card has been formatted in a computer or other device:</b> Format the memory card using  <b>FORMAT</b>.</li><li>• <b>The memory card contacts require cleaning:</b> Clean the contacts with a soft, dry cloth. If the message is repeated, format the card. If the message persists, replace the card.</li><li>• <b>Camera malfunction:</b> Contact a FUJIFILM dealer.</li></ul>
<b>LENS ERROR</b>	Turn the camera off, remove the lens, and clean the mounting surfaces, then replace the lens and turn the camera on. If the problem persists, contact a FUJIFILM dealer.

Warning	Description
<b>CARD ERROR</b>	<ul style="list-style-type: none"> <li>• <b>The memory card is not formatted for use in the camera:</b> Format the card.</li> <li>• <b>The memory card contacts require cleaning or the memory card is damaged:</b> Clean the contacts with a soft, dry cloth. If the message is repeated, format the card. If the message persists, replace the card.</li> <li>• <b>Incompatible memory card:</b> Use a compatible card.</li> <li>• <b>Camera malfunction:</b> Contact a FUJIFILM dealer.</li> </ul>
<b>PROTECTED CARD</b>	The memory card is locked. Unlock the card.
<b>BUSY</b>	The memory card is incorrectly formatted. Use the camera to format the card.
<b>SD MEMORY FULL</b>	The memory card is full and pictures cannot be recorded. Delete pictures or insert a memory card with more free space.
<b>WRITE ERROR</b>	<ul style="list-style-type: none"> <li>• <b>Memory card error or connection error:</b> Reinsert the card or turn the camera off and then on again. If the message persists, contact a FUJIFILM dealer.</li> <li>• <b>Not enough memory remaining to record additional pictures:</b> Delete pictures or insert a memory card with more free space.</li> <li>• <b>The memory card is not formatted:</b> Format the memory card.</li> </ul>
<b>FRAME NO. FULL</b>	The camera has run out of frame numbers (current frame number is 999-9999). Format the memory card and select <b>RENEW</b> for <b>FRAME NO.</b> . Take a picture to reset frame numbering to 100-0001, then select <b>CONTINUOUS</b> for <b>FRAME NO.</b>

Warning	Description
<b>READ ERROR</b>	<ul style="list-style-type: none"> <li>• <b>The file is corrupt or was not created with the camera:</b> The file cannot be viewed.</li> <li>• <b>The memory card contacts require cleaning:</b> Clean the contacts with a soft, dry cloth. If the message is repeated, format the card. If the message persists, replace the card.</li> <li>• <b>Camera malfunction:</b> Contact a FUJIFILM dealer.</li> </ul>
<b>PROTECTED FRAME</b>	An attempt was made to delete or rotate to a protected picture. Remove protection and try again.
<b>CAN NOT CROP</b>	The picture is damaged or was not created with the camera.
<b>DPOF FILE ERROR</b>	Print orders can contain no more than 999 pictures. Copy any additional pictures you wish to print to another memory card and create a second print order.
<b>CAN NOT ROTATE</b>	The selected picture cannot be rotated.
 <b>CAN NOT ROTATE</b>	Movies cannot be rotated.
<b>CAN NOT SET DPOF</b>	The picture cannot be printed using DPOF.
 <b>CAN NOT SET DPOF</b>	Movies cannot be printed using DPOF.
 <b>CANNOT EXECUTE</b>	Red-eye removal cannot be applied to movies.
 <b>CANNOT EXECUTE</b>	Red-eye removal cannot be applied to pictures created with other devices.
	Turn the camera off and wait for it to cool. Mottling may increase in pictures taken when this warning is displayed.

## Memory Card Capacity

The following table shows the recording time or number of pictures available at different image sizes. All figures are approximate; file size varies with the scene recorded, producing wide variations in the number of files that can be stored. The number of exposures or length remaining may not diminish at an even rate.

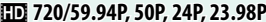
		Capacity		8 GB		16 GB	
		FINE	NORMAL	FINE	NORMAL		
Photos	 <b>3:2</b>	660	1060	1330	2120		
	<b>RAW (UNCOMPRESSED)</b>	180		370			
Movies <sup>1,2</sup>	 <b>2160/15P</b>	9 minutes		20 minutes			
	 <b>1080/59.94P, 50P, 24P, 23.98P</b>	26 minutes		54 minutes			
	 <b>720/59.94P, 50P, 24P, 23.98P</b>	51 minutes		105 minutes			

1 Use a UHS speed class 3 card or better.

2 Individual movies cannot exceed 30 minutes in length.

 Although movie recording will continue without interruption when the file size reaches 4GB, subsequent footage will be recorded to a separate file which must be viewed separately.



## Specifications



System										
<b>Model</b>	FUJIFILM X-A5									
<b>Product Number</b>	FF170003									
<b>Effective pixels</b>	Approx. 24.2 million									
<b>Image sensor</b>	23.5 mm × 15.7 mm (APS-C format), CMOS (complementary metal-oxide semiconductor) image sensor with square pixels and primary color filter									
<b>Storage media</b>	FUJIFILM-recommended SD/SDHC/SDXC memory cards									
<b>Memory card slots</b>	SD memory card slot (UHS-1)									
<b>File system</b>	Compliant with Design Rule for Camera File System (DCF), Exif 2.3, and Digital Print Order Format (DPOF)									
<b>File format</b>	<ul style="list-style-type: none"><li>• <b>Still pictures:</b> Exif 2.3 JPEG (compressed); RAW (original RAF format, special purpose software required); RAW+JPEG available</li><li>• <b>Movies:</b> H.264 standard with stereo sound (MOV)</li></ul>									
<b>Image size</b>	<table><tbody><tr><td><b>L</b> 3:2 (6000 × 4000)</td><td><b>L</b> 16:9 (6000 × 3376)</td><td><b>L</b> 1:1 (4000 × 4000)</td></tr><tr><td><b>M</b> 3:2 (4240 × 2832)</td><td><b>M</b> 16:9 (4240 × 2384)</td><td><b>M</b> 1:1 (2832 × 2832)</td></tr><tr><td><b>S</b> 3:2 (3008 × 2000)</td><td><b>S</b> 16:9 (3008 × 1688)</td><td><b>S</b> 1:1 (2000 × 2000)</td></tr></tbody></table> <p>RAW (6000 × 4000)</p> <p><b>L</b> panorama: vertical (2160 × 9600)/horizontal (9600 × 1440)</p> <p><b>M</b> panorama: vertical (2160 × 6400)/horizontal (6400 × 1440)</p>	<b>L</b> 3:2 (6000 × 4000)	<b>L</b> 16:9 (6000 × 3376)	<b>L</b> 1:1 (4000 × 4000)	<b>M</b> 3:2 (4240 × 2832)	<b>M</b> 16:9 (4240 × 2384)	<b>M</b> 1:1 (2832 × 2832)	<b>S</b> 3:2 (3008 × 2000)	<b>S</b> 16:9 (3008 × 1688)	<b>S</b> 1:1 (2000 × 2000)
<b>L</b> 3:2 (6000 × 4000)	<b>L</b> 16:9 (6000 × 3376)	<b>L</b> 1:1 (4000 × 4000)								
<b>M</b> 3:2 (4240 × 2832)	<b>M</b> 16:9 (4240 × 2384)	<b>M</b> 1:1 (2832 × 2832)								
<b>S</b> 3:2 (3008 × 2000)	<b>S</b> 16:9 (3008 × 1688)	<b>S</b> 1:1 (2000 × 2000)								
<b>Lens mount</b>	FUJIFILM X mount									
<b>Sensitivity</b>	<ul style="list-style-type: none"><li>• <b>Still pictures:</b> Standard output sensitivity equivalent to ISO 200–12800 in increments of 1/3 EV; AUTO; extended output sensitivity equivalent to ISO 100, 25600, or 51200</li><li>• <b>Movies:</b> Standard output sensitivity equivalent to ISO 400–6400 in increments of 1/3 EV; AUTO</li></ul>									
<b>Metering</b>	256-segment through-the-lens (TTL) metering; MULTI, SPOT, AVERAGE									
<b>Exposure control</b>	Programmed AE (with program shift); shutter-priority AE; aperture-priority AE; manual exposure									
<b>Exposure compensation</b>	<ul style="list-style-type: none"><li>• <b>Still pictures:</b> –5 EV–+5 EV in increments of 1/3 EV</li><li>• <b>Movies:</b> –2 EV–+2 EV in increments of 1/3 EV</li></ul>									

## System

### Shutter speed

- **Mechanical shutter**
  - **Mode P:** 4 s to  $\frac{1}{4000}$  s
  - **Other modes:** 30 s to  $\frac{1}{4000}$  s
  - **Bulb:** Max. 60 min.
- **Mechanical+electronic**
  - **Mode P:** 4 s to  $\frac{1}{16000}$  s
  - **Mode A:** 30 s to  $\frac{1}{16000}$  s
  - **Mode S/M:** 30 s to  $\frac{1}{32000}$  s
  - **Bulb:** Max. 60 min.
- **Electronic shutter**
  - **Mode P:** 4 s to  $\frac{1}{16000}$  s
  - **Mode A:** 30 s to  $\frac{1}{16000}$  s
  - **Mode S/M:** 30 s to  $\frac{1}{32000}$  s

### Continuous

Mode	Frame rate (fps)	Frames per burst
	6.0	Up to approximately 10
	3.0	Up to approximately 50

 The frame rate varies with shooting conditions and the number of images recorded. In addition, the frame rate and number of frames per burst may vary depending on the type of memory card used.

### Focus

- **Mode:** Single or continuous AF; manual focus with focus ring; AF+MF
- **Focus-area selection:** SINGLE POINT, ZONE, WIDE/TRACKING
- **Autofocus system:** Intelligent hybrid AF (TTL contrast-detect/phase-detection AF) with AF-assist illuminator

### White balance

Custom, color temperature selection, auto, direct sunlight, shade, daylight fluorescent, warm white fluorescent, cool white fluorescent, incandescent, underwater

### Self-timer



































Off, 2 sec., 10 sec., Face auto shutter, Smile, Buddy, Group

### Flash

- **Type:** Manual pop-up flash unit
- **Guide number:** Approx. 5.7/18 (ISO 200, m/ft.), 4/13 (ISO 100, m/ft.)

### Flash mode

Auto, fill flash, off, slow sync, rear-curtain sync, commander (red-eye removal off); auto with red-eye removal, fill flash with red-eye removal, off, slow sync with red-eye removal, rear-curtain sync with red-eye removal, commander (red-eye removal on)

System													
Hot shoe	Accessory shoe with TTL contacts												
Sync contact	X contact; supports sync speeds as fast as $\frac{1}{180}$ s												
Sync terminal	–												
Viewfinder	–												
LCD monitor	Fixed 3.0-in/7.6 cm, 1040k-dot color touch screen LCD monitor, tilting												
Movies	<ul style="list-style-type: none"> <li> <b>Movies with stereo sound</b> <table border="0" data-bbox="336 385 890 516"> <tr> <td> 2160/15P</td> <td> 1080/59.94P</td> <td> 720/59.94P</td> </tr> <tr> <td></td> <td> 1080/50P</td> <td> 720/50P</td> </tr> <tr> <td></td> <td> 1080/24P</td> <td> 720/24P</td> </tr> <tr> <td></td> <td> 1080/23.98P</td> <td> 720/23.98P</td> </tr> </table> </li> <li> <b>Silent HD high-speed movies</b> <ul style="list-style-type: none"> <li>1.6×  59.94P  100P</li> <li>2×  50P  100P</li> <li>3.3×  29.97P  100P</li> <li>4×  25P  100P</li> </ul> </li> </ul>	 2160/15P	 1080/59.94P	 720/59.94P		 1080/50P	 720/50P		 1080/24P	 720/24P		 1080/23.98P	 720/23.98P
 2160/15P	 1080/59.94P	 720/59.94P											
	 1080/50P	 720/50P											
	 1080/24P	 720/24P											
	 1080/23.98P	 720/23.98P											

Input/output terminals	
Digital input/output	USB 2.0 High-Speed Micro USB connector (Micro-B)
HDMI output	HDMI Micro connector (Type D)
Microphone/remote release connector	ø2.5 mm 3-pole mini jack

Power supply/other	
Power supply	NP-W126S rechargeable battery
Camera size (W × H × D)	116.9 mm × 67.7 mm × 40.4 mm (31.6 mm excluding projections, measured at thinnest part)/4.6 in. × 2.7 in. × 1.6 in. (1.2 in.)
Camera weight	Approx. 311 g/11.0 oz., excluding battery, accessories, and memory card
Shooting weight	Approx. 361 g/12.7 oz., including battery and memory card
Operating conditions	<ul style="list-style-type: none"> <li>• <b>Temperature:</b> 0 °C to +40 °C/+32 °F to +104 °F</li> <li>• <b>Humidity:</b> 10% to 80% (no condensation)</li> </ul>

## Power supply/other

### Battery life

- **Battery type:** NP-W126S (type supplied with camera) (approximate number of frames that can be taken with a fully-charged battery and XF35 mm f/1.4 R lens)

#### Approximate number of frames

450

Mode	Actual Battery life of movie capture	Continuance Battery life of movie capture
4K	Approx. 90 minutes	Approx. 150 minutes
FULL HD	Approx. 100 minutes	Approx. 170 minutes

CIPA standard, measured using battery supplied with camera and SD memory card.

**Note:** Number of shots that can be taken with battery varies with battery charge level and will decline at low temperatures.

## Wireless transmitter

### Wireless LAN

Standards	IEEE 802.11b/g/n (standard wireless protocol)
Operating frequency (center frequency)	• <b>Japan, China:</b> 2,412 MHz–2,472 MHz (13 channels) • <b>Other countries:</b> 2,412 MHz–2,462 MHz (11 channels)
Maximum radio-frequency power (EIRP)	9.31 dBm
Access protocols	Infrastructure

### Bluetooth®

Standards	Bluetooth version 4.1 (Bluetooth Low Energy)
Operating frequency (center frequency)	2,402 MHz–2,480 MHz
Maximum radio-frequency power (EIRP)	7.92 dBm

**NP-W126S rechargeable battery**

<b>Nominal voltage</b>	7.2 V DC
<b>Nominal capacity</b>	1,260 mAh
<b>Operating temperature</b>	0 °C to +40 °C/+32 °F to +104 °F
<b>Dimensions</b> (W × H × D)	36.4 mm × 47.1 mm × 15.7 mm/1.4 in. × 1.8 in. × 0.6 in.
<b>Weight</b>	Approx. 47 g/1.7 oz.

**AC power adapter****AC-5VF**

<b>Rated input</b>	100 V – 240 V AC, 50/60 Hz
<b>Input capacity</b>	11.6 VA (100 V), 15.5 VA (240 V)
<b>Rated output</b>	5.0 V DC, 1000 mA
<b>Operating temperature</b>	0 °C to +40 °C/+32 °F to +104 °F
<b>Weight</b>	Approx. 32 g/1.1 oz. (AC power adapter only)

**AC-5VG**

<b>Rated input</b>	100 V – 240 V AC, 50/60 Hz
<b>Input capacity</b>	10.5 VA (100 V), 11.9 VA (240 V)
<b>Rated output</b>	5.0 V DC, 1000 mA
<b>Operating temperature</b>	0 °C to +40 °C/+32 °F to +104 °F
<b>Weight</b>	Approx. 26 g ± 15%/0.9 oz. ± 15%

Weight and dimensions vary with the country or region of sale. Labels, menus, and other displays may differ from those on the actual camera.

 Specifications and performance are subject to change without notice. FUJIFILM will not be held liable for any errors this manual may contain. The appearance of the product may differ from that described in this manual.

# **MEMO**

---

---

---

---

---

---

---

---

---

---

---

---

---

---

---

---

---

---

---

---

---

---

---

---

---

---

---

---



# FUJIFILM

---

**FUJIFILM Corporation**

7-3, AKASAKA 9-CHOME, MINATO-KU, TOKYO 107-0052, JAPAN

[http://www.fujifilm.com/products/digital\\_cameras/index.html](http://www.fujifilm.com/products/digital_cameras/index.html)

