

FUJIFILM

DIGITAL CAMERA

GFX 50S

Owner's Manual

Introduction

Thank you for your purchase of this product. Be sure that you have read this manual and understood its contents before using the camera. Keep the manual where it will be read by all who use the product.

For the Latest Information

For the latest information on this product, including the latest versions of the manuals and sample color photographs, visit:

<http://fujifilm-dsc.com/manuals/>



The site can be accessed not only from your computer but also from smartphones and tablets.

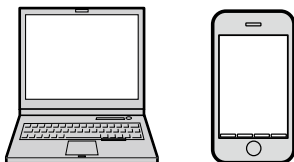



Chapter Index

Menu List	iv
1 Before You Begin	1
2 First Steps	23
3 Basic Photography and Playback	39
4 Movie Recording and Playback	45
5 Taking Photographs	51
6 The Shooting Menus	85
7 Playback and the Playback Menu	119
8 The Setup Menus	145
9 Shortcuts	175
10 Peripherals and Optional Accessories	187
11 Connections	207
12 Technical Notes	217



Menu List







Camera menu options are listed below.

Shooting Menus

Adjust settings when shooting photos or movies.

 See page 85 for details.





IQ	IMAGE QUALITY SETTING	86	AF/MF	AF/MF SETTING	87
1/3	IMAGE SIZE	86	1/2	FOCUS AREA	97
	IMAGE QUALITY	87		AF MODE	97
	RAW RECORDING	87		STORE AF MODE BY ORIENTATION	98
	FILM SIMULATION	88		RAPID AF	98
	GRAIN EFFECT	89		AF POINT DISPLAY  	98
	COLOR CHROME EFFECT	89		NUMBER OF FOCUS POINTS	99
	DYNAMIC RANGE	89		PRE-AF	99
	WHITE BALANCE	90		FACE/EYE DETECTION SETTING	100
2/3	HIGHLIGHT TONE	93	AF+MF	101	
	SHADOW TONE	93	MF ASSIST	101	
	COLOR	93	FOCUS CHECK	102	
	SHARPNESS	93	INTERLOCK SPOT AE & FOCUS AREA	102	
	NOISE REDUCTION	94	INSTANT AF SETTING	102	
	LONG EXPOSURE NR	94	DEPTH-OF-FIELD SCALE	103	
	LENS MODULATION OPTIMIZER	94	RELEASE/FOCUS PRIORITY	103	
	COLOR SPACE	94	TOUCH SCREEN MODE	103	
3/3	PIXEL MAPPING	95			
	SELECT CUSTOM SETTING	95			
	EDIT/SAVE CUSTOM SETTING	96			

 SHOOTING SETTING 		 FLASH SETTING 		
	SELF-TIMER	104	FLASH FUNCTION SETTING	113
	SAVE SELF-TIMER SETTING	105	RED EYE REMOVAL	113
	INTERVAL TIMER SHOOTING	105	TTL-LOCK MODE	114
1½	AE BKT SETTING	106	LED LIGHT SETTING	114
	FILM SIMULATION BKT	106	MASTER SETTING	115
	PHOTOMETRY	107	CH SETTING	115
	SHUTTER TYPE	108	 MOVIE SETTING 	
	IS MODE	109	MOVIE MODE	116
	ISO AUTO SETTING	109	MOVIE AF MODE	116
2½	MOUNT ADAPTOR SETTING	110	HDMI OUTPUT INFO DISPLAY	117
	WIRELESS COMMUNICATION	112	HDMI REC CONTROL	117
			MIC LEVEL ADJUSTMENT	117

The Playback Menu

Adjust playback settings.







 See page 126 for details.

 PLAY BACK MENU 		 PLAY BACK MENU 		
	SWITCH SLOT	126	VOICE MEMO SETTING	136
	RAW CONVERSION	127	COPY	137
	ERASE	129	WIRELESS COMMUNICATION	138
1½	CROP	131	2½ PHOTOBOOK ASSIST	139
	RESIZE	132	PRINT ORDER (DPOF)	141
	PROTECT	133	instax PRINTER PRINT	142
	IMAGE ROTATE	134	DISP ASPECT	143
	RED EYE REMOVAL	135		

Setup Menus

Adjust basic camera settings.

 See page 145 for details.

 USER SETTING		 SCREEN SETTING	
FORMAT	:146	EVF BRIGHTNESS	:153
DATE/TIME	:147	EVF COLOR	:153
TIME DIFFERENCE	:147	LCD BRIGHTNESS	:153
言語/LANG.	:148	LCD COLOR	:153
MY MENU SETTING	:148	1/2 IMAGE DISP.	:154
SENSOR CLEANING	:149	AUTOROTATE DISPLAYS	:154
BATTERY AGE	:149	PREVIEW EXP./WB IN MANUAL MODE	:155
RESET	:150	PREVIEW PIC. EFFECT	:155
 SOUND SETTING		FRAMING GUIDELINE	:156
AF BEEP VOL.	:151	AUTOROTATE PB	:157
SELF-TIMER BEEP VOL.	:151	2/2 FOCUS SCALE UNITS	:157
OPERATION VOL.	:151	DISP. CUSTOM SETTING	:158
HEADPHONES VOLUME	:152	SUB MONITOR SETTING	:159
SHUTTER VOLUME	:152		
SHUTTER SOUND	:152		
PLAYBACK VOLUME	:152		

1/2	BUTTON/DIAL SETTING		SAVE DATA SETTING	
	FOCUS LEVER SETTING	160	FRAME NO.	169
	EDIT/SAVE QUICK MENU	161	SAVE ORG IMAGE	170
	FUNCTION (Fn) SETTING	162	EDIT FILE NAME	170
1/2	SELECTOR BUTTON SETTING	164	CARD SLOT SETTING (STILL IMAGE)	170
	COMMAND DIAL SETTING	164	SWITCH SLOT (SEQUENTIAL)	170
	SHUTTER AF	164	MOVIE FILE DESTINATION	171
	SHUTTER AE	165	COPYRIGHT INFO	171
	SHOOT WITHOUT LENS	165	CONNECTION SETTING	
	FOCUS RING	165	WIRELESS SETTINGS	172
	AE/AF-LOCK MODE	165	PC CONNECTION SETTING	173
2/2	EXPO. COMP. BUTTON SETTING	166	GEOTAGGING SET-UP	173
	TOUCH SCREEN SETTING	166	instax PRINTER CONNECTION SETTING	173
	LOCK	166	PC SHOOT MODE	174
	POWER MANAGEMENT			
	AUTO POWER OFF	167		
	SHOOTING STAND BY MODE	167		
	AUTO POWER SAVE	168		



Table of Contents

Introduction.....	ii
For the Latest Information.....	ii
Menu List.....	iv
Shooting Menus.....	iv
The Playback Menu.....	v
Setup Menus.....	vi
Supplied Accessories.....	xvii
About This Manual.....	xviii
Symbols and Conventions.....	xviii
Terminology.....	xviii

1 Before You Begin **1**



Parts of the Camera.....	2
The Selector.....	5
The Focus Stick.....	5
The Shutter Speed and Sensitivity Dials.....	5
The Command Dials.....	6
The Drive Button.....	7
The Indicator Lamp.....	8
The LCD Monitor.....	9
The Viewfinder.....	10
Attaching the Viewfinder.....	11
The Eye Cup.....	11
Focusing the Viewfinder.....	11
Camera Displays.....	12
The Electronic Viewfinder.....	12
Display Rotation.....	13
The LCD Monitor.....	14
Choosing a Display Mode.....	16
Adjusting Display Brightness.....	16
The DISP/BACK Button.....	17
Customizing Standard Indicators.....	19
The Secondary LCD Monitor.....	21
Using the Menus.....	22

2	First Steps	23
	Attaching the Shoulder Strap.....	24
	Attaching a Lens.....	26
	Charging the Battery	27
	Inserting the Battery.....	30
	Inserting Memory Cards.....	32
	Using Two Cards.....	33
	Compatible Memory Cards.....	34
	Turning the Camera On and Off.....	35
	Checking the Battery Level.....	36
	Basic Setup.....	37
	Choosing a Different Language.....	38
	Changing the Time and Date.....	38
3	Basic Photography and Playback	39
	Taking Photographs (Mode P).....	40
	▶ Viewing Pictures.....	43
	🗑 Deleting Pictures.....	44
4	Movie Recording and Playback	45
	🎥 Recording Movies.....	46
	Adjusting Movie Settings.....	48
	▶ Viewing Movies.....	49
5	Taking Photographs	51
	P, S, A, and M Modes.....	52
	Mode P: Program AE.....	52
	Mode S: Shutter-Priority AE.....	54
	Mode A: Aperture-Priority AE.....	58
	Mode M: Manual Exposure.....	60
	Autofocus.....	62
	Focus Mode.....	63
	Autofocus Options (AF Mode).....	65
	Focus-Point Selection.....	67
	Touch Focus Controls.....	70
	Manual Focus.....	71
	Checking Focus.....	73

ISO Sensitivity	74
Auto Sensitivity (A)	75
Metering	76
Exposure Compensation	77
Focus/Exposure Lock	78
The AF-L and AE-L Buttons	79
BKT Bracketing	80
AE BKT	80
ISO ISO BKT	80
FILM SIMULATION BKT	80
WB WHITE BALANCE BKT	81
DR DYNAMIC RANGE BKT	81
Continuous Shooting (Burst Mode)	82
Multiple Exposures	83

6 The Shooting Menus **85**

IMAGE QUALITY SETTING	86
IMAGE SIZE	86
IMAGE QUALITY	87
RAW RECORDING	87
FILM SIMULATION	88
GRAIN EFFECT	89
COLOR CHROME EFFECT	89
DYNAMIC RANGE	89
WHITE BALANCE	90
HIGHLIGHT TONE	93
SHADOW TONE	93
COLOR	93
SHARPNESS	93
NOISE REDUCTION	94
LONG EXPOSURE NR	94
LENS MODULATION OPTIMIZER	94
COLOR SPACE	94
PIXEL MAPPING	95
SELECT CUSTOM SETTING	95
EDIT/SAVE CUSTOM SETTING	96

AF/MF	AF/MF SETTING	97
	FOCUS AREA	97
	AF MODE	97
	STORE AF MODE BY ORIENTATION	98
	RAPID AF	98
	AF POINT DISPLAY  	98
	NUMBER OF FOCUS POINTS	99
	PRE-AF	99
	FACE/EYE DETECTION SETTING	100
	AF+MF	101
	MF ASSIST	101
	FOCUS CHECK	102
	INTERLOCK SPOT AE & FOCUS AREA	102
	INSTANT AF SETTING	102
	DEPTH-OF-FIELD SCALE	103
	RELEASE/FOCUS PRIORITY	103
	TOUCH SCREEN MODE	103
SHOOTING	SHOOTING SETTING	104
	SELF-TIMER	104
	SAVE SELF-TIMER SETTING	105
	INTERVAL TIMER SHOOTING	105
	AE BKT SETTING	106
	FILM SIMULATION BKT	106
	PHOTOMETRY	107
	SHUTTER TYPE	108
	IS MODE	109
	ISO AUTO SETTING	109
	MOUNT ADAPTOR SETTING	110
	WIRELESS COMMUNICATION	112
FLASH	FLASH SETTING	113
	FLASH FUNCTION SETTING	113
	RED EYE REMOVAL	113
	TTL-LOCK MODE	114
	LED LIGHT SETTING	114
	MASTER SETTING	115
	CH SETTING	115

 MOVIE SETTING	116
MOVIE MODE.....	116
MOVIE AF MODE	116
HDMI OUTPUT INFO DISPLAY.....	117
HDMI REC CONTROL.....	117
MIC LEVEL ADJUSTMENT	117

7 Playback and the Playback Menu **119**

The Playback Display	120
The DISP/BACK Button	121
Viewing Pictures	123
Playback Zoom.....	124
Multi-Frame Playback.....	124
Playback Touch Controls	125
 The Playback Menu	126
SWITCH SLOT.....	126
RAW CONVERSION	127
ERASE.....	129
CROP	131
RESIZE.....	132
PROTECT.....	133
IMAGE ROTATE	134
RED EYE REMOVAL	135
VOICE MEMO SETTING	136
COPY	137
WIRELESS COMMUNICATION	138
PHOTOBOOK ASSIST	139
PRINT ORDER (DPOF).....	141
instax PRINTER PRINT.....	142
DISP ASPECT	143

8 The Setup Menus **145**

 USER SETTING	146
FORMAT	146
DATE/TIME.....	147
TIME DIFFERENCE	147
言語/LANG.	148

MY MENU SETTING	148
SENSOR CLEANING	149
BATTERY AGE	149
RESET	150
■ SOUND SETTING	151
AF BEEP VOL.....	151
SELF-TIMER BEEP VOL.....	151
OPERATION VOL.....	151
HEADPHONES VOLUME	152
SHUTTER VOLUME.....	152
SHUTTER SOUND.....	152
PLAYBACK VOLUME	152
■ SCREEN SETTING	153
EVF BRIGHTNESS.....	153
EVF COLOR.....	153
LCD BRIGHTNESS.....	153
LCD COLOR.....	153
IMAGE DISP.....	154
AUTOROTATE DISPLAYS.....	154
PREVIEW EXP/WB IN MANUAL MODE.....	155
PREVIEW PIC. EFFECT	155
FRAMING GUIDELINE.....	156
AUTOROTATE PB	157
FOCUS SCALE UNITS.....	157
DISP. CUSTOM SETTING.....	158
SUB MONITOR SETTING	159
■ BUTTON/DIAL SETTING	160
FOCUS LEVER SETTING.....	160
EDIT/SAVE QUICK MENU.....	161
FUNCTION (Fn) SETTING	162
SELECTOR BUTTON SETTING.....	164
COMMAND DIAL SETTING	164
SHUTTER AF.....	164
SHUTTER AE.....	165
SHOOT WITHOUT LENS.....	165
FOCUS RING	165
AE/AF-LOCK MODE.....	165

EXPO. COMP. BUTTON SETTING.....	166
TOUCH SCREEN SETTING.....	166
LOCK.....	166
⚡ POWER MANAGEMENT.....	167
AUTO POWER OFF.....	167
SHOOTING STAND BY MODE.....	167
AUTO POWER SAVE.....	168
💾 SAVE DATA SETTING.....	169
FRAME NO.....	169
SAVE ORG IMAGE.....	170
EDIT FILE NAME.....	170
CARD SLOT SETTING (STILL IMAGE).....	170
SWITCH SLOT (SEQUENTIAL).....	170
MOVIE FILE DESTINATION.....	171
COPYRIGHT INFO.....	171
📶 CONNECTION SETTING.....	172
WIRELESS SETTINGS.....	172
PC CONNECTION SETTING.....	173
GEOTAGGING SET-UP.....	173
instax PRINTER CONNECTION SETTING.....	173
PC SHOOT MODE.....	174

9 Shortcuts 175

Shortcut Options.....	176
The Q (Quick Menu) Button.....	177
The Quick Menu Display.....	177
Viewing and Changing Settings.....	178
Editing the Quick Menu.....	179
The Fn (Function) Buttons.....	180
Assigning Roles to the Function Buttons.....	182
MY MY MENU.....	184
MY MENU SETTING.....	185

10	Peripherals and Optional Accessories	187
	Lenses.....	188
	Lens Parts.....	188
	Lens Care.....	189
	Removing Lens Caps.....	189
	Attaching Lens Hoods.....	189
	Vertical Battery Grips	190
	Attaching the VB-GF1.....	191
	Inserting a Battery.....	192
	Viewfinder Tilt Adapters	194
	Attaching the EVF-TL1.....	195
	Using the EVF-TL1.....	196
	External Flash Units	197
	Flash Settings.....	198
	SYNC TERMINAL.....	199
	SHOE MOUNT FLASH.....	200
	MASTER(OPTICAL).....	203
11	Connections	207
	HDMI Output	208
	Connecting to HDMI Devices.....	208
	Shooting.....	209
	Playback.....	209
	Wireless Transfer	210
	Wireless Connections: Smartphones.....	210
	Connecting to Computers via USB	211
	Tethered Shooting.....	211
	Copying Pictures to a Computer.....	212
	Connecting the Camera.....	213
	instax SHARE Printers	215
	Establishing a Connection.....	215
	Printing Pictures.....	216

12 Technical Notes	217
Accessories from FUJIFILM	218
For Your Safety	221
Product Care	230
Cleaning the Image Sensor	231
Firmware Updates.....	232
Checking the Firmware Version.....	232
Troubleshooting.....	233
Warning Messages and Displays	239
Memory Card Capacity	242
Specifications	243

Supplied Accessories

The following are included with the camera:

- NP-T125 rechargeable battery
- BC-T125 battery charger
- Plug adapter
- EVF-GFX1 interchangeable electronic viewfinder
- Body cap
- Strap clips (× 2)
- Clip locks (× 2)
- Shoulder strap
- Cable protector
- Hot shoe cover (comes attached to hot shoe)
- Sync terminal cap (comes attached to camera)
- Vertical battery grip connector cover (comes attached to camera)
- *Owner's Manual* (this manual)





The plug adapter supplied with the camera varies with the country or region of purchase; be sure to use the adapter appropriate to your country or region as described in the enclosed notice. The viewfinder can be removed, but the text that follows assumes that it is attached.

About This Manual

This manual contains instructions for your FUJIFILM GFX 50S digital camera. Be sure you have read and understood its contents before proceeding.

Symbols and Conventions

The following symbols are used in this manual:

-  Information that should be read to prevent damage to the product.
-  Additional information that may be helpful when using the product.
-  Pages on which related information may be found.

Menus and other text in the displays are shown in **bold**. Illustrations are for explanatory purposes only; drawings may be simplified, while photographs are not necessarily taken with the model of camera described in this manual.

Terminology

The optional SD, SDHC, and SDXC memory cards the camera uses to store pictures are referred to as “memory cards”. The electronic viewfinder may be referred to as the “EVF” and the LCD monitor as the “LCD”.

Before You Begin



Parts of the Camera

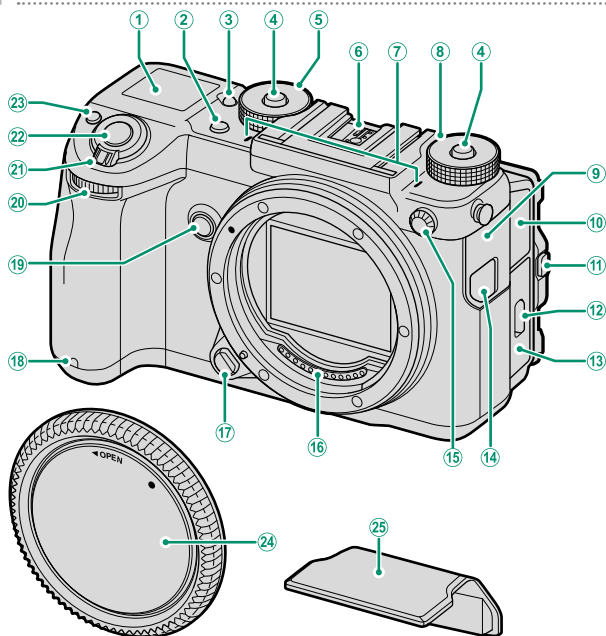

① Secondary LCD monitor.....	21	⑭ Remote release connector cover.....	57
② Drive button.....	7	⑮ Sync terminal.....	199
③ Secondary monitor backlight button.....	21	⑯ Lens signal contacts.....	26, 188
④ Dial lock release.....	5	⑰ Lens release button.....	26
⑤ Shutter speed dial.....	5, 52, 54, 58, 60	⑱ Self-timer lamp.....	104
⑥ Hot shoe.....	194, 200	⑲ Fn2 button.....	180
⑦ Microphone.....	47, 117	⑳ Front command dial.....	6, 164
⑧ Sensitivity dial.....	5, 74, 109	㉑ ON/OFF switch.....	35
⑨ Connector cover 1.....	29, 57, 208, 213	㉒ Shutter button.....	42
⑩ Connector cover 2.....	47, 117, 152	㉓ Fn1 button.....	180
⑪ Tilt lock release.....	9	☑ (exposure compensation) button.....	77
⑫ Battery-chamber cover latch.....	30	㉔ Body cap.....	26
⑬ Battery-chamber cover.....	30	㉕ Hot shoe cover.....	194, 200

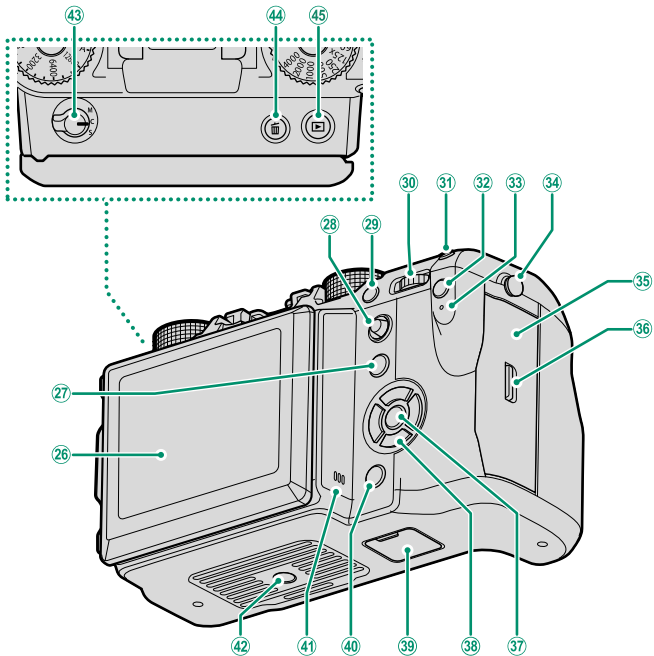

26	LCD monitor	9, 14, 16	36	Memory card slot cover latch	32
	Touch screen	70, 103, 125, 166	37	MENU/OK button	5, 22
27	Fn5 button	180	38	Selector buttons	5, 164
28	Focus stick (focus lever)	5, 67, 160	39	Vertical battery grip connector cover	190
29	Fn4 button	180	40	DISP (display)/BACK button	17, 121
30	Rear command dial	6, 123, 164	41	Speaker	49, 152
31	Fn3 button	180	42	Tripod mount	
32	Q (quick menu) button	177	43	Focus mode selector	63
33	Indicator lamp	8, 29, 193	44	⌫ (delete) button	44
34	Strap anchor	24	45	▶ (playback) button	43
35	Memory card slot cover	32			

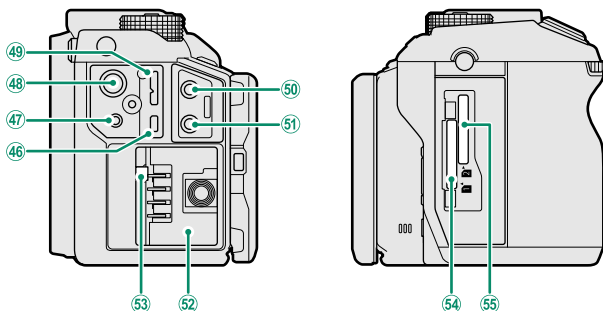

46	HDMI Micro connector (Type D).....	208	51	Headphone jack.....	152
47	Remote release connector (ø 2.5 mm)	57	52	Battery chamber	30
48	15 V DC-IN connector.....	29	53	Battery latch	31
49	Micro USB (Micro-B) USB 3.0/ USB 2.0 connector	57, 213	54	Memory card slot 1.....	32
50	Microphone jack (ø 3.5 mm).....	47, 117	55	Memory card slot 2.....	32

The Cable Protector

- 1 The cable protector prevents accidental disconnection of the USB cable or AC adapter. Attach the protector as shown and tighten the lock screw.
- 2 Connect the cable and pass it through the protector as shown.

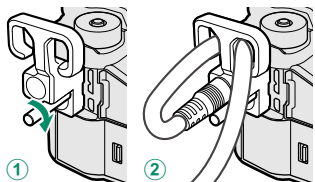

The Serial Number Plate

Do not remove the serial number plate, which provides the FCC ID, KC mark, serial number, and other important information.

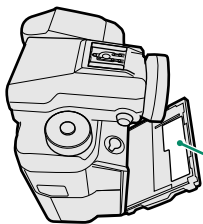



Serial number plate

The Selector

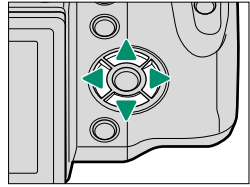
Press the selector up (▲), right (▶), down (▼), or left (◀) to highlight items. The up, right, down, and left buttons also double as function buttons **Fn6** through **Fn9** (📖 180).



Control Lock

To prevent accidental operation of the selector and the **Q** and **Fn5** buttons during shooting, press **MENU/OK** until  is displayed. The controls can be unlocked by pressing **MENU/OK** until  is no longer displayed.

The Focus Stick

Tilt or press the focus stick to select the focus area.

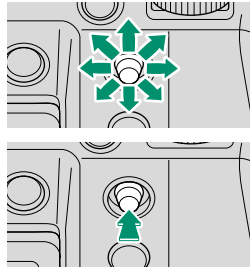

The Shutter Speed and Sensitivity Dials

Press the dial lock release to release the dial before rotating it to the desired setting. Press the release again to lock the dial in place.

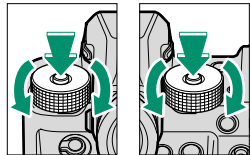



Sensitivity

Shutter speed

The Command Dials

Rotate or press the command dials to:

	Front command dial	Rear command dial
<p>Rotate</p> 	<ul style="list-style-type: none">• Choose the desired combination of shutter speed and aperture (program shift)• Adjust aperture• Adjust sensitivity when is C selected with the sensitivity dial• View other pictures during playback• Select menu tabs or page through menus	<ul style="list-style-type: none">• Choose the desired combination of shutter speed and aperture (program shift)• Choose a shutter speed• Adjust exposure compensation by pressing the  button and rotating the dial• Adjust settings in the quick menu• Choose the size of the focus frame• Zoom in or out during focus zoom or in full frame or multi-frame playback• Highlight menu items
<p>Press</p> 	<p>Switch back and forth between aperture and sensitivity when C is selected with sensitivity dial.</p>	<ul style="list-style-type: none">• Perform the function assigned to function button Fn10• Zoom in on the active focus point during playback• Press and hold to choose the manual focus mode focus display

The Drive Button

Pressing the drive button displays the following drive mode options.

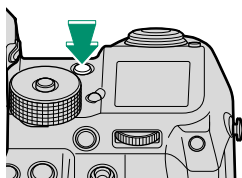

Mode		Mode	
STILL IMAGE (single frame)	40	WHITE BALANCE BKT (white balance bracketing)	81
CONTINUOUS (burst mode)	82	DYNAMIC RANGE BKT (dynamic range bracketing)	81
AE BKT (exposure bracketing)	80	MULTIPLE EXPOSURE	83
ISO BKT (sensitivity bracketing)	80	MOVIE	46
FILM SIMULATION BKT (film simulation bracketing)	80		

The Indicator Lamp

When the viewfinder is not in use, camera status is shown by the indicator lamp.

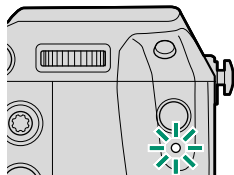



Indicator lamp	Camera status
Glows green	Focus locked.
Blinks green	Focus or slow shutter speed warning. Pictures can be taken.
Blinks green and orange	Recording pictures. Additional pictures can be taken.
Glows orange	Recording pictures. No additional pictures can be taken at this time.
Blinks orange	Flash charging; flash will not fire when picture is taken.
Blinks red	Lens or memory error.

 Warnings may also appear in the display.

The LCD Monitor

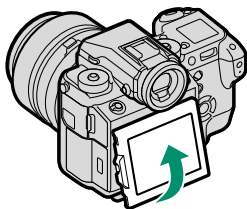
The LCD monitor can be tilted for easier viewing, but be careful not to touch the wires or trap fingers or other objects behind the monitor. Touching the wires could cause camera malfunction.



 The LCD monitor also functions as a touch screen (📖 70, 125).

“Tall” (Portrait) Orientation

When the camera is rotated to take pictures in “tall” (portrait) orientation, you can press the tilt lock release and tilt the display as shown. This is particularly useful when taking pictures from low or high angles.

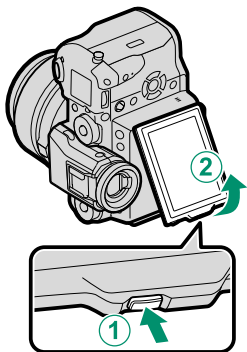

 Hold the camera as shown when taking “tall” (portrait) orientation pictures from high angles.

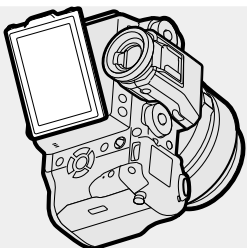

The Viewfinder

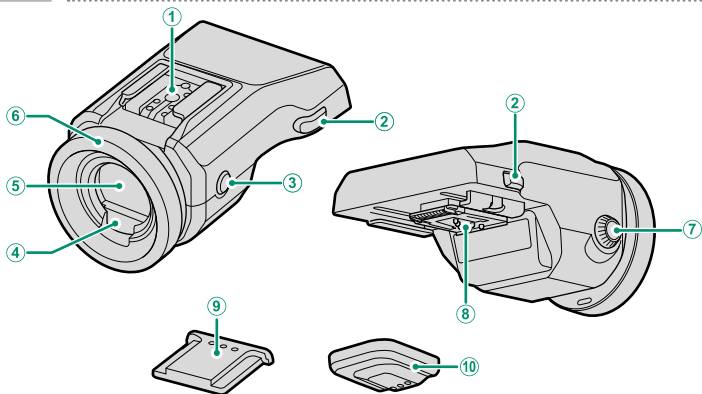

① Hot shoe.....	194, 200	⑥ Eye cup	11
② Viewfinder lock releases	11	⑦ Diopter adjustment control	11
③ VIEW MODE button.....	16	⑧ Connectors.....	11
④ Eye sensor	16	⑨ Hot shoe cover	
⑤ Electronic viewfinder (EVF).....	12, 16	⑩ Connector cover	

The EVF-TL1

The optional EVF-TL1 tilt adapter lets you swivel the viewfinder left or right $\pm 45^\circ$ or up or down between 0° and 90° (📖 194).

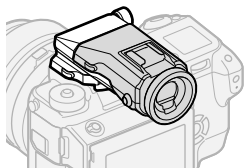

Attaching the Viewfinder

Using the viewfinder makes it easier to frame your subject accurately. Remove the hot shoe cover from the camera and slide the viewfinder onto the hot shoe, stopping when it clicks into place.

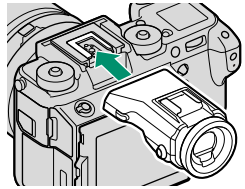

Removing the Viewfinder

Keeping the lock releases pressed (①), press down on the front of the viewfinder (②) and slide it off as shown.

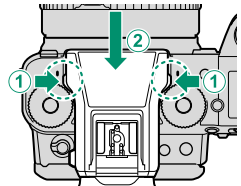

The Eye Cup

To remove the eye cup, press the bottom in with both thumbs and slide eye cup up.

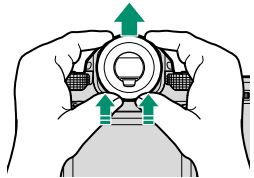

Focusing the Viewfinder

The camera is equipped with diopter adjustment in the range -4 to $+2 \text{ m}^{-1}$ to accommodate individual differences in vision. Rotate the diopter adjustment control until the viewfinder display is in sharp focus.

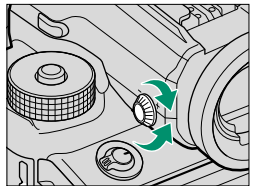

Camera Displays

This section lists the indicators that may be displayed during shooting.

! For illustrative purposes, displays are shown with all indicators lit.

The Electronic Viewfinder

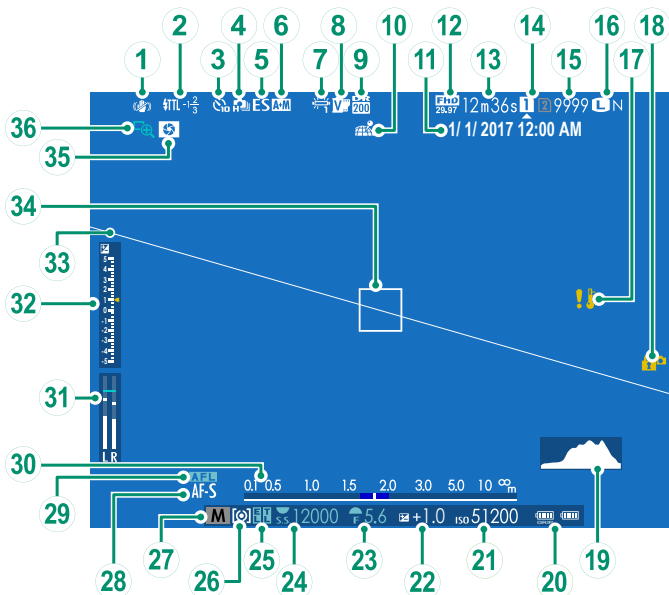

① IS mode.....	109	①9 Histogram.....	20
② Flash (TTL) mode.....	200	②0 Battery level.....	36
Flash compensation.....	200	②1 Sensitivity.....	74
③ Self-timer indicator.....	104	②2 Exposure compensation.....	77
④ Continuous mode.....	82	②3 Aperture.....	53, 58, 60
⑤ Shutter type.....	108	②4 Shutter speed.....	53, 54, 60
⑥ AF+MF indicator.....	101	②5 AE lock.....	79, 165
⑦ White balance.....	90	TTL lock.....	114, 163, 183
⑧ Film simulation.....	88	②6 Metering.....	76
⑨ Dynamic range.....	89	②7 Shooting mode.....	52
⑩ Location data download status.....	173	②8 Focus mode [†]	63
⑪ Date and time.....	37, 147	②9 AF lock.....	79, 165
⑫ Movie mode.....	46, 116	③0 Distance indicator.....	73
⑬ Time remaining.....	46	③1 Recording level.....	117
⑭ Card slot options.....	33, 170	③2 Exposure indicator.....	60, 77
⑮ Number of available frames*.....	242	③3 Virtual horizon.....	20
⑯ Image quality and size.....	86, 87	③4 Focus frame.....	67, 78
⑰ Temperature warning.....	241	③5 Depth-of-field preview.....	59, 73
⑱ Control lock.....	5	③6 Focus check.....	73, 102

* Shows "9999" if there is space for over 9999 frames.

† In-focus (☉) or manual focus (MF) indicator may also be displayed.

Control Lock

Pressing a locked control displays a  icon.



Display Rotation

When **ON** is selected for **SCREEN SET-UP > AUTOROTATE DISPLAYS**, the indicators in the viewfinder and LCD monitor automatically rotate to match camera orientation.

The LCD Monitor

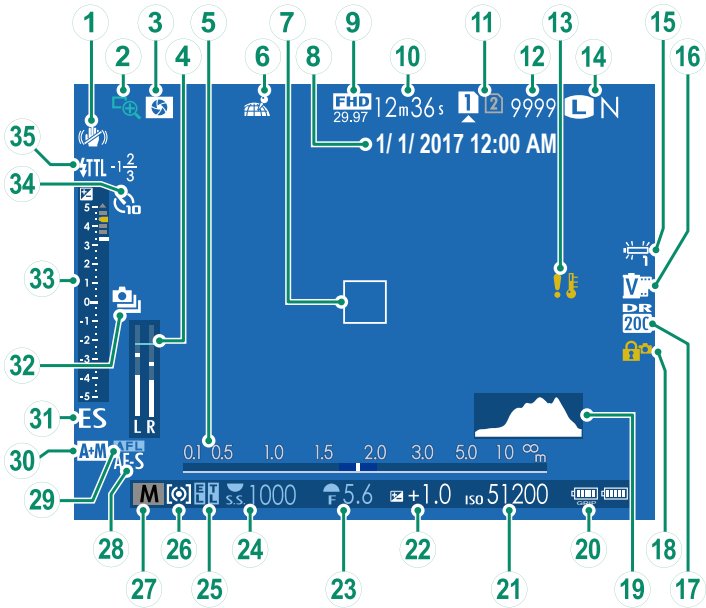

① IS mode	109	②0 Battery level	36
② Focus check.....	73, 102	②1 Sensitivity.....	74
③ Depth-of-field preview	59, 73	②2 Exposure compensation	77
④ Recording level.....	117	②3 Aperture.....	53, 58, 60
⑤ Distance indicator.....	73	②4 Shutter speed.....	53, 54, 60
⑥ Location data download status	173	②5 AE lock.....	79, 165
⑦ Focus frame	67, 78	TTL lock	114, 163, 183
⑧ Date and time	37, 147	②6 Metering.....	76
⑨ Movie mode.....	46, 116	②7 Shooting mode.....	52
⑩ Time remaining	46	②8 Focus mode [†]	63
⑪ Card slot options	33, 170	②9 AF lock.....	79, 165
⑫ Number of available frames*	242	③0 AF+MF indicator	101
⑬ Temperature warning.....	241	③1 Shutter type.....	108
⑭ Image quality and size	86, 87	③2 Continuous mode	82
⑮ Film simulation.....	88	③3 Exposure indicator.....	60, 77
⑯ White balance.....	90	③4 Self-timer indicator.....	104
⑰ Dynamic range.....	89	③5 Flash (TTL) mode	200
⑱ Control lock.....	5	Flash compensation.....	200
⑲ Histogram.....	20		

* Shows "9999" if there is space for over 9999 frames.

† In-focus (⊙) or manual focus (MF) indicator may also be displayed.

Control Lock

Pressing a locked control displays a  icon.



Choosing a Display Mode

Press the **VIEW MODE** button to cycle through the following display modes:

- EYE SENSOR** **EYE SENSOR**: Putting your eye to the viewfinder turns the viewfinder on and the LCD monitor off; taking your eye away turns the viewfinder off and LCD monitor on.
- EVF ONLY**: Viewfinder on, LCD monitor off.
- LCD ONLY**: LCD monitor on, viewfinder off.
- EVF ONLY + EYE SENSOR**: Putting your eye to the viewfinder turns the viewfinder on; taking it away turns the viewfinder off. The LCD monitor remains off.

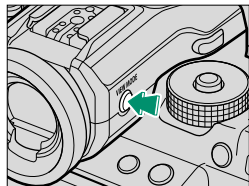

The Eye Sensor

The eye sensor may respond to objects other than your eye or to light shining directly on the sensor.

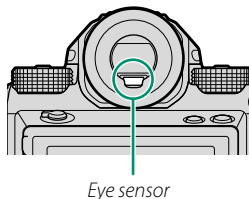

Adjusting Display Brightness

The brightness and hue of the viewfinder and LCD monitor can be adjusted using the items in the **SCREEN SET-UP** menu. Choose **EVF BRIGHTNESS** or **EVF COLOR** to adjust viewfinder brightness or hue, **LCD BRIGHTNESS** or **LCD COLOR** to do the same for the LCD monitor.

The DISP/BACK Button

The **DISP/BACK** button controls the display of indicators in the viewfinder and LCD monitor.

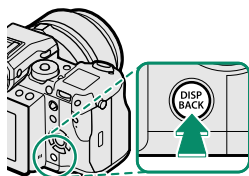

Viewfinder

Full screen

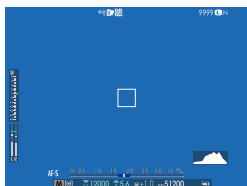

*Full screen
(no indicators)*



Dual display (manual focus mode only; 18)

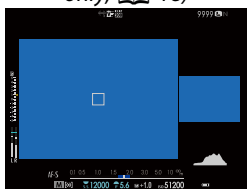

Standard indicators



Standard (no indicators)



LCD Monitor

Standard indicators

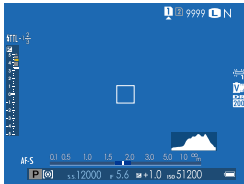

No indicators

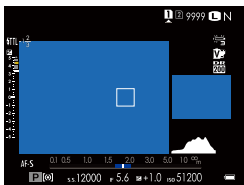

Dual display

(manual focus mode only)

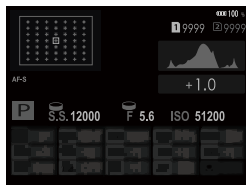

Info display

The Dual Display

The dual display consists of a large full-frame window and a smaller close-up of the focus area.

Customizing Standard Indicators

To choose the items shown in the standard indicator display:

1 Display standard indicators.

Press the **DISP/BACK** button until standard indicators are displayed.

2 Select **DISP. CUSTOM SETTING**.

Select **SCREEN SET-UP > DISP. CUSTOM SETTING** in the setup menu.

3 Choose items.

Highlight items and press **MENU/OK** to select or deselect.

- FRAMING GUIDELINE
- ELECTRONIC LEVEL
- FOCUS FRAME
- AF DISTANCE INDICATOR
- MF DISTANCE INDICATOR
- HISTOGRAM
- LIVE VIEW HIGHLIGHT ALERT
- SHOOTING MODE
- APERTURE/S-SPEED/ISO
- INFORMATION BACKGROUND
- Expo. Comp. (Digit)
- Expo. Comp. (Scale)
- FOCUS MODE
- PHOTOMETRY
- SHUTTER TYPE
- FLASH
- CONTINUOUS MODE
- DUAL IS MODE
- TOUCH SCREEN MODE
- WHITE BALANCE
- FILM SIMULATION
- DYNAMIC RANGE
- FRAMES REMAINING
- IMAGE SIZE/QUALITY
- MOVIE MODE & REC. TIME
- MIC LEVEL
- BATTERY LEVEL
- FRAMING OUTLINE

4 Save changes.

Press **DISP/BACK** to save changes.

5 Exit the menus.

Press **DISP/BACK** as needed to exit the menus and return to the shooting display.

Virtual Horizon

Selecting **ELECTRONIC LEVEL** displays a virtual horizon. The camera is level when the two lines overlap. Note that the virtual horizon may not be displayed if the camera lens is pointed up or down. For a 3D display, press the function button to which **ELECTRONIC LEVEL** is assigned (📖 162, 182)

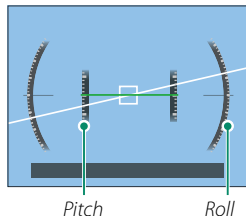

Framing Outline

Enable **FRAMING OUTLINE** to make the borders of the frame easier to see against dark backgrounds.

Histograms

Histograms show the distribution of tones in the image. Brightness is shown by the horizontal axis, the number of pixels by the vertical axis.

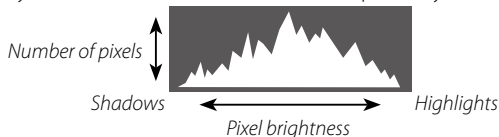

To view separate RGB histograms and a display showing areas of the frame that will be overexposed at current settings superimposed on the view through the lens, press the function button to which **HISTOGRAM** is assigned (📖 162, 182).

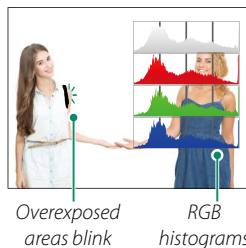

The Secondary LCD Monitor

The secondary LCD monitor shows eight camera settings, four as text (items ① to ④) and four as icons (items ⑤ to ⑧). Use **SCREEN SET-UP > SUB MONITOR SETTING** to choose the items displayed. Items for display when you are taking photographs can be selected separately from those shown in movie mode; in the lists that follow, items not available in movie mode are indicated by asterisks (“*”).

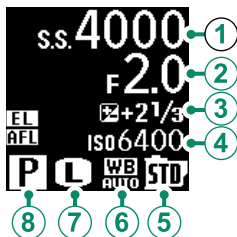

At default settings, the secondary LCD shows the following:

- **Text:** ① SHUTTER SPEED, ② APERTURE, ③ EXPO. COMP., ④ ISO
- **Icons:** ⑤ FILM SIMULATION, ⑥ WHITE BALANCE, ⑦ IMAGE SIZE*, ⑧ SHOOTING MODE

The following options are also available:

- **Text:** MOVIE MODE (icon only)*, FRAMES REM.*, REC. TIME, NONE
- **Icons:** PHOTOMETRY, DRIVE MODE*, FOCUS MODE, IMAGE QUALITY*, BATTERY LEVEL, CARD SLOT OPTIONS, SHUTTER TYPE*, DYNAMIC RANGE*, MOVIE MODE*, NONE

The Secondary Monitor Backlight

To turn on the secondary monitor backlight when you find the secondary LCD monitor too dark to read, press the secondary monitor backlight button. Press the button again to turn the backlight off.

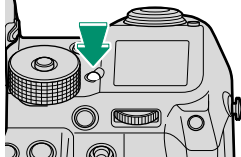

Using the Menus

To display the menus, press **MENU/OK**.

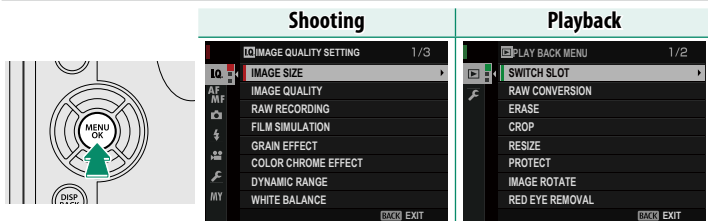

To navigate the menus:

- 1 Press **MENU/OK** to display the menus.

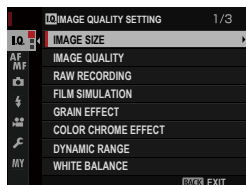

- 2 Press the selector left to highlight the tab for the current menu.

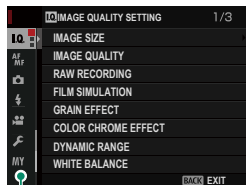

Tab

- 3 Press the selector up or down to highlight the tab (**Io**, **AF/MF**, **Ⓜ**, **Ⓝ**, **MY**, **▶** or **Ⓜ**) containing the desired item.
- 4 Press the selector right to place the cursor in the menu.

 Use the front command dial to select menu tabs or page through menus and the rear command dial to highlight menu items.

First Steps

2

Attaching the Shoulder Strap

Attach the strap clips to the shoulder strap and then attach the strap to the camera.

1 Attach a clip to the strap.

Slide a clip onto the strap (①) and pass the strap through the strap adjuster and strap retainer (②).

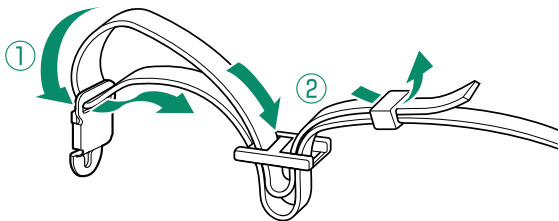

2 Attach the clip to the camera.

Pull the strap upwards (①) until the clip clicks securely into place (②) in the ✓ (“correct”) position. If the clip is in the ⊘ (“incorrect”) position, press the tongue (③) until it clicks into place in the ✓ position.

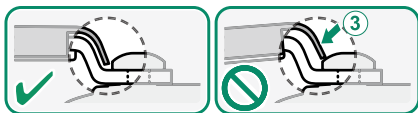

Correct

Incorrect

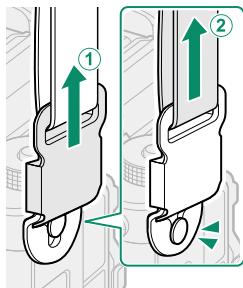

3 Repeat Steps 1–2 for the second clip.

! Attach the strap as shown.

To avoid dropping the camera, be sure the strap is correctly secured.

Locking the Clips

Be sure to insert the clip locks after confirming that clips are correctly attached (📖 24). To prevent the strap becoming detached accidentally, insert the clip locks as shown.

⚠️ The clips are small and easily swallowed; keep out of reach of children.

Be sure that the clips are correctly attached before inserting the locks (📖 24). Failure to observe this precaution could damage the clips.

Do not attempt to attach the clips with the locks inserted. Failure to observe this precaution could damage the clips.

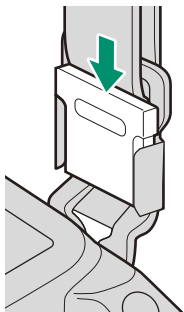

Unclipping the Strap

1 Remove the clip locks.

⚠️ Remove the strap from the clips before removing the locks.

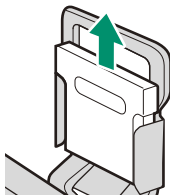

2 Grasping both sides of the clip, release it as shown (1) and then slide it from the anchor (2).

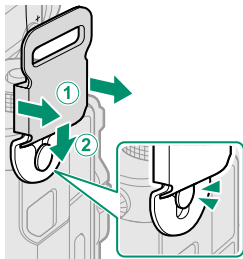

Attaching a Lens

The camera can be used with lenses for the FUJIFILM G-mount.

Remove the body cap from the camera and the rear cap from the lens. Place the lens on mount, keeping the marks on the lens and camera aligned, and then rotate the lens until it clicks into place.

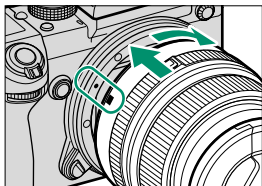

! Be careful not to touch the camera's internal parts. Do not press the lens release button while attaching the lens and be sure the latch has securely clicked into place.

Removing Lenses

To remove the lens, turn the camera off, then press the lens release button and rotate the lens as shown.

! To prevent dust accumulating on the lens or inside the camera, replace the lens caps and camera body cap when the lens is not attached.

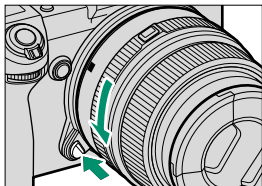

Lenses and Other Optional Accessories

The camera can be used with lenses and accessories for the FUJIFILM G-mount.

! Before attaching or removing (exchanging) lenses, attach the lens caps and check that the lenses are free of dust and other foreign matter. Do not change lenses in direct sunlight or under another bright light source, as light focused into the interior of the camera could cause it to malfunction.

Charging the Battery

The battery is not charged at shipment. Before proceeding, use the supplied battery charger to fully charge the battery.

 An NP-T125 rechargeable battery is supplied with the camera. Charging takes about 140 minutes.

1 Connect the plug adapter.

The plug adapter supplied with the camera varies with the country or region of purchase; use the adapter appropriate to your country or region as described in the enclosed notice.

2 Place the battery in the charger.

Insert the battery in the orientation shown by the arrow.

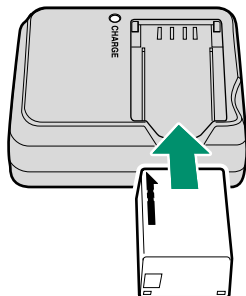

3 Plug the charger in.

Plug the charger into an indoor power outlet. The charging indicator will light.

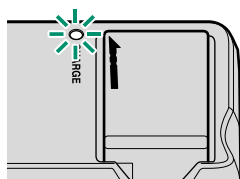

4 Charge the battery.

Remove the battery when charging is complete.

The Charging Indicator

The charging indicator shows battery charge status as follows:

Charging indicator	Battery status	Action
Off	Battery not inserted.	Insert the battery.
	Battery fully charged.	Remove the battery.
On	Battery charging.	—
Blinks	Battery fault.	Unplug the charger and remove the battery.

 Use the charger with the plug adapter for your country or region.

Do not affix labels or other objects to the battery. Failure to observe this precaution could make it impossible to remove the battery from the camera.

Do not short the battery terminals. The battery could overheat.

Read the cautions in "The Battery and Power Supply".

Use only battery chargers designated for use with the battery. Failure to observe this precaution could result in product malfunction.

Do not remove the labels from the battery or attempt to split or peel the outer casing.

The battery gradually loses its charge when not in use. Charge the battery one or two days before use. If the battery fails to hold a charge, it has reached the end of its charging life and must be replaced.

Unplug the charger when it is not in use.

Remove dirt from the battery terminals with a clean, dry cloth. Failure to observe this precaution could prevent the battery from charging.



Note that charging times increase at low temperatures.

Charging via AC Adapter

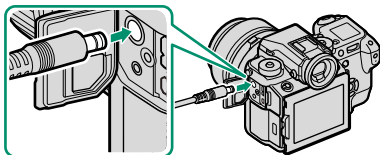
The battery inserted in the camera will also charge when the camera is powered by an optional AC-15V AC adapter. Charging takes about 120 minutes.



Battery charge status is shown by battery status icons when the camera is on (playback mode) and by the indicator lamp when the camera is off.

Battery status icon (camera on)	Indicator lamp (camera off)	Battery status
 (yellow)	On	Battery charging
 (green)	Off	Charging complete
 (red)	Blinks	Battery fault

Inserting the Battery

After charging the battery, insert the battery in the camera as described below.

1 Open the battery-chamber cover.

Slide the battery-chamber latch as shown and open the battery-chamber cover.

! Do not remove the battery when the camera is on. Failure to observe this precaution could damage image files or memory cards.

Do not use excessive force when handling the battery-chamber cover.

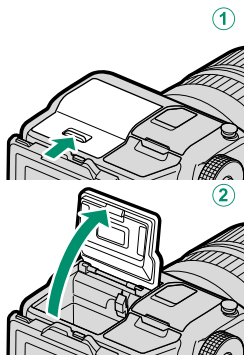

2 Insert the battery.

Using the battery to keep the battery latch pressed to one side, insert the battery contacts first in the direction shown by the arrow. Confirm that the battery is securely latched.

! Insert the battery in the orientation shown. *Do not use force or attempt to insert the battery upside down or backwards.* The battery will slide in easily in the correct orientation.

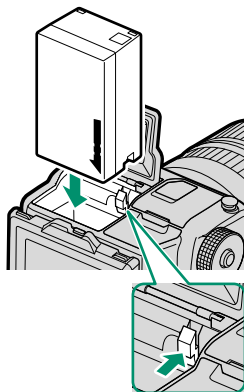

3 Close the battery-chamber cover.

Close and latch the cover.

⚠ If the cover does not close, check that the battery is in the correct orientation. Do not attempt to force the cover shut.

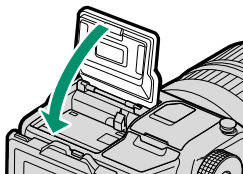

Removing the Battery

Before removing the battery, *turn the camera off* and open the battery-chamber cover.

To remove the battery, press the battery latch to the side, and slide the battery out of the camera as shown.

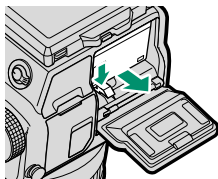

⚠ The battery may become hot when used in high-temperature environments. Observe caution when removing the battery.

Inserting Memory Cards

Pictures are stored on memory cards (sold separately).

 The camera can be used with two cards, one in each of its two slots.

1 Open the memory card slot cover.

Unlatch and open the cover.

 Do not remove memory cards when the camera is on. Failure to observe this precaution could damage image files or memory cards.

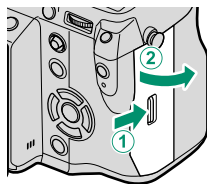

2 Insert the memory card.

Holding the card in the orientation shown, slide it in until it clicks into place at the back of the slot.

 Be sure card is in the correct orientation; do not insert at an angle or use force.

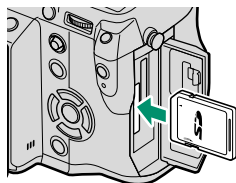

3 Close the memory card slot cover.

Close and latch the cover.

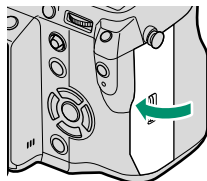

Removing Memory Cards

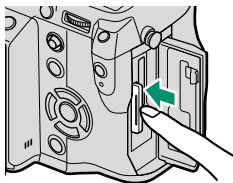

Before removing memory cards, *turn the camera off* and open the memory card slot cover.

Press and release the card to eject it part way (to prevent the card falling from the slot, press the center of the card and release it slowly, without removing your finger from the card). The card can then be removed by hand.



Using Two Cards

The camera can be used with two cards, one in each of its two slots. At default settings, photos are saved to the card in the second slot only when the card in the first slot is full. This can be changed using **SAVE DATA SET-UP > CARD SLOT SETTING (STILL IMAGE)**.

Option	Description	Display
SEQUENTIAL (default)	The card in the second slot is used only when the card in the first slot is full. If the second slot is selected for SAVE DATA SET-UP > SWITCH SLOT (SEQUENTIAL) , recording will start on the card in the second slot and switch to the first slot when the card in the second slot is full.	
BACKUP	Each picture is recorded twice, once to each card.	
RAW / JPEG	As for SEQUENTIAL , except that the RAW copy of pictures taken with FINE+RAW or NORMAL+RAW selected for IMAGE QUALITY SETTING > IMAGE QUALITY will be saved to the card in the first slot and the JPEG copy to the card in the second slot.	

The card used to store movies can be selected using **SAVE DATA SET-UP > MOVIE FILE DESTINATION**.

Compatible Memory Cards

FUJIFILM and SanDisk SD, SDHC, and SDXC memory cards have been approved for use in the camera; UHS-II cards can be used in both slots, while cards with a UHS speed class of 1 or better are recommended for movies. A complete list of approved memory cards is available at http://www.fujifilm.com/support/digital_cameras/compatibility/. Operation is not guaranteed with other cards. The camera cannot be used with xD-Picture Cards or MultiMediaCard (MMC) devices.

! Do not turn the camera off or remove the memory card while the memory card is being formatted or data are being recorded to or deleted from the card. Failure to observe this precaution could damage the card.

Memory cards can be locked, making it impossible to format the card or to record or delete images. Before inserting a memory card, slide the write-protect switch to the unlocked position.



Format memory cards before first use, and be sure to reformat all memory cards after using them in a computer or other device.

Memory cards are small and can be swallowed; keep out of reach of children. If a child swallows a memory card, seek medical assistance immediately.

miniSD or microSD adapters that are larger or smaller than memory cards may not eject normally; if the card does not eject, take the camera to an authorized service representative. Do not forcibly remove the card.

Do not affix labels or other objects to memory cards. Peeling labels can cause camera malfunction.

Movie recording may be interrupted with some types of memory card.

Formatting a memory card in the camera creates a folder in which pictures are stored. Do not rename or delete this folder or use a computer or other device to edit, delete, or rename image files. Always use the camera to delete pictures; before editing or renaming files, copy them to a computer and edit or rename the copies, not the originals. Renaming the files on the camera can cause problems during playback.



Turning the Camera On and Off

Use the **ON/OFF** switch to turn the camera on and off.

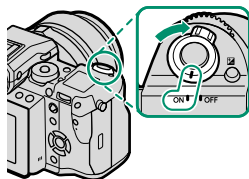
Rotate the switch to **ON** to turn the camera on, or to **OFF** to turn the camera off.



 Fingerprints and other marks on the lens or viewfinder can affect pictures or the view through the viewfinder. Keep the lens and viewfinder clean.







 Press the  button to start playback. Press the shutter button halfway to return to shooting mode.

The camera will turn off automatically if no operations are performed for the length of time selected for  **POWER MANAGEMENT > AUTO POWER OFF**. To reactivate the camera after it has turned off automatically, press the shutter button halfway or turn the **ON/OFF** switch to **OFF** and then back to **ON**.

Checking the Battery Level

After turning the camera on, check the battery level in the display.

Battery level is shown as follows:

Indicator	Description
	Battery partially discharged.
	Battery about 80% full.
	Battery about 60% full.
	Battery about 40% full.
	Battery about 20% full.
 (red)	Low battery. Charge as soon as possible.
 (blinks red)	Battery exhausted. Turn camera off and recharge battery.

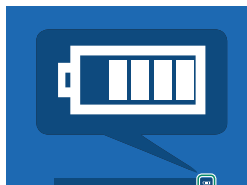

Basic Setup

A language-selection dialog is displayed the first time the camera is turned on.

1 Turn the camera on.

A language-selection dialog will be displayed.

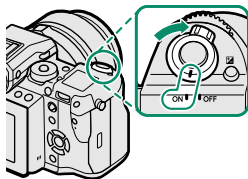

2 Choose a language.

Highlight a language and press **MENU/OK**.

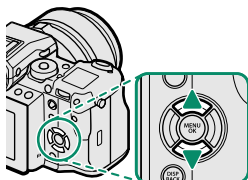

3 Set the date and time.

Press the selector left or right to highlight the year, month, day, hour, or minute and press up or down to change. To change the order in which the year, month, and day are displayed, highlight the date format and press the selector up or down.

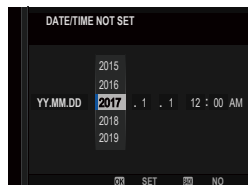

Press **MENU/OK** to exit to shooting mode when settings are complete.



If the battery is removed for an extended period, the camera clock will be reset and the language-selection dialog will be displayed when the camera is turned on.

Skipping the Current Step

Press **DISP/BACK** to skip the current step. Any steps you skip will be displayed the next time the camera is turned on.

Choosing a Different Language

To change the language:

- 1 Display language options.**
Select **USER SETTING > 言語/LANG..**
- 2 Choose a language.**
Highlight the desired option and press **MENU/OK**.

Changing the Time and Date

To set the camera clock:

- 1 Display DATE/TIME options.**
Select **USER SETTING > DATE/TIME**.
- 2 Set the clock.**
Press the selector left or right to highlight the year, month, day, hour, or minute and press up or down to change. Press **MENU/OK** to set the clock.

Basic Photography and Playback

3

Taking Photographs (Mode P)

This section describes how to take pictures using program AE (mode P). See pages 52–61 for information on S, A, and M modes.

1 Adjust settings for program AE.

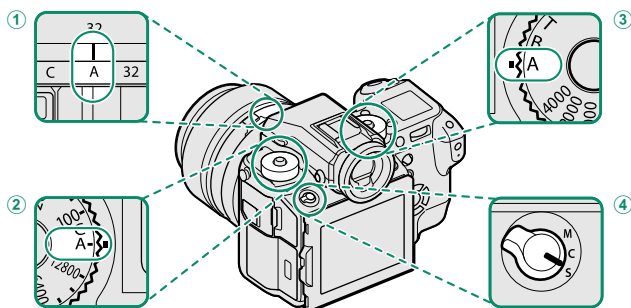

- 1 **Aperture** (📖 52): Select A (auto).
- 2 **Sensitivity** (📖 74): Select A (auto).
- 3 **Shutter speed** (📖 52): Select A (auto).
- 4 **Focus mode** (📖 63): Select S (single AF).

 To use the shutter speed and sensitivity dials, press the dial lock release and rotate the dial to the desired setting.

2 Check the shooting mode.

Confirm that P appears in the display.

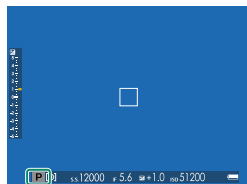

3 Ready the camera.

Hold the camera steady with both hands and brace your elbows against your sides. Shaking or unsteady hands can blur your shots.

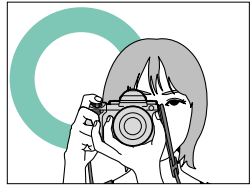

To prevent pictures that are out of focus or too dark (underexposed), keep your fingers and other objects away from the lens.

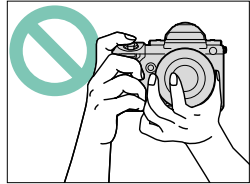

4 Frame the picture.

Lenses with Zoom Rings

Use the zoom ring to frame the picture in the display. Rotate the ring left to zoom out, right to zoom in.

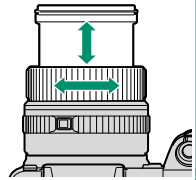

5 Focus.

Press the shutter button halfway to focus.

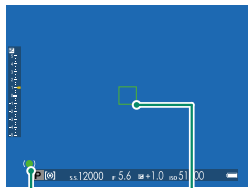

Focus

indicator

Focus frame

If the camera is able to focus, it will beep twice and focus area and focus indicator will glow green. Focus and exposure will lock while the shutter button is pressed halfway.

If the camera is unable to focus, the focus frame will turn red, **!AF** will be displayed, and the focus indicator will blink white.

6 Shoot.

Smoothly press the shutter button the rest of the way down to take the picture.



Viewing Pictures

Pictures can be viewed in the viewfinder or LCD monitor.

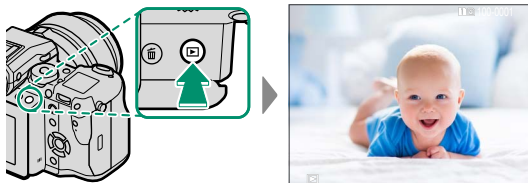

To view pictures full frame, press .



Additional pictures can be viewed by pressing the selector left or right or rotating the front command dial. Press the selector or rotate the dial right to view pictures in the order recorded, left to view pictures in reverse order. Keep the selector pressed to scroll rapidly to the desired frame.

 Pictures taken using other cameras are marked with a  (“gift image”) icon to warn that they may not display correctly and that playback zoom may not be available.

Two Memory Cards

If two memory cards are inserted, you can press and hold the  button to choose a card for playback. You can also select a card using the  **PLAY BACK MENU > SWITCH SLOT** option.

Deleting Pictures



Use the  button to delete pictures.

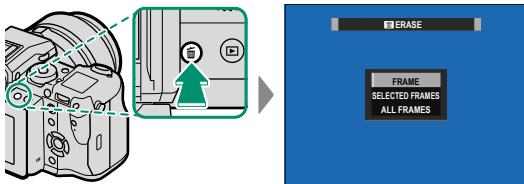

 Deleted pictures cannot be recovered. Copy important pictures to a computer or other storage device before proceeding.

- 1 With a picture displayed full frame, press the  button and select **FRAME**.



- 2 Press the selector left or right to scroll through pictures and press **MENU/OK** to delete (a confirmation dialog is not displayed). Repeat to delete additional pictures.

 Protected pictures cannot be deleted. Remove protection from any pictures you wish to delete ( 133).

Pictures can also be deleted from the menus using the  **PLAY BACK MENU > ERASE** option ( 129).

Movie Recording and Playback

4



Recording Movies

This section describes how to film movies in auto mode.

- 1 Press the drive mode button and select  **MOVIE**.
- 2 Adjust settings for program AE.

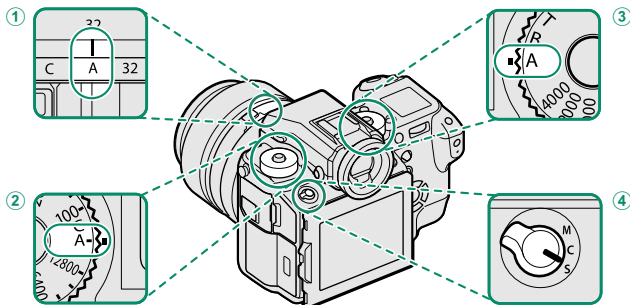

- 1 **Aperture** (📖 52): Select **A** (auto).
- 2 **Sensitivity** (📖 74): Select **A** (auto).
- 3 **Shutter speed** (📖 52): Select **A** (auto).
- 4 **Focus mode** (📖 63): Select **S** (single AF).

 To use the shutter speed and sensitivity dials, press the dial lock release and rotate the dial to the desired setting.

- 3 Press the shutter button to start recording. A recording indicator (●) and the time remaining are displayed while recording is in progress.

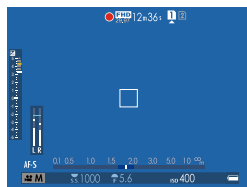

- 4 Press the button again to end recording. Recording ends automatically when the maximum length is reached or the memory card is full.

 Sound is recorded via the built-in microphone or an optional external microphone. Do not cover the microphone during recording. Note that the microphone may pick up lens noise and other sounds made by the camera during recording.

Vertical or horizontal streaks may appear in movies containing very bright subjects. This is normal and does not indicate a malfunction.

 The indicator lamp lights while recording is in progress. During recording, you can change exposure compensation by up to ± 2 EV and adjust zoom using the zoom ring on the lens (if available).

If the lens is equipped with an aperture mode switch, select the aperture mode before beginning recording. If an option other than **A** is selected, shutter speed and aperture can be adjusted while recording is in progress.

Recording may be unavailable at some settings, while in other cases settings may not apply during recording.

Using an External Microphone

Sound can be recorded with external microphones that connect using jacks 3.5 mm in diameter; microphones that require plug-in power cannot be used. See the microphone manual for details.

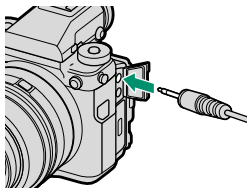

Adjusting Movie Settings

Frame size and rate can be selected using **MOVIE SETTING** > **MOVIE MODE**, while the card used to store movies can be selected using **SAVE DATA SET-UP** > **MOVIE FILE DESTINATION**. Focus mode is selected using the focus mode selector; for continuous focus adjustment, select **C**, or choose **S** and enable Intelligent Face Detection. Intelligent Face Detection is not available in focus mode **M**.

Depth of Field

Choose low f-numbers to soften background details.

Viewing Movies





View movies on the camera.

In full-frame playback, movies are identified by a  icon.

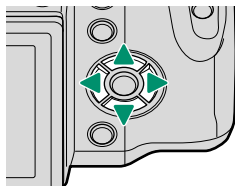



The following operations can be performed while a movie is displayed:



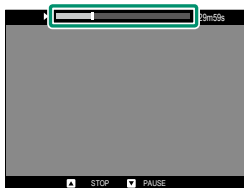

Selector	Playback in progress ()	Playback paused ()
		End playback
	Pause playback	Start/resume playback
	Adjust speed	Single frame rewind/advance

Progress is shown in the display during playback.



 Do not cover the speaker during playback.

 Press **MENU/OK** to pause playback and display volume controls. Press the selector up or down to adjust the volume; press **MENU/OK** again to resume playback. Volume can also be adjusted using  **SOUND SET-UP > PLAYBACK VOLUME**.

Playback Speed

Press the selector left or right to adjust playback speed during playback. Speed is shown by the number of arrows (▶ or ◀).

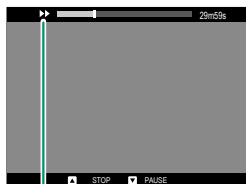

Arrows

Taking Photographs

5

P, S, A, and M Modes

P, S, A, and M modes give you varying degrees of control over shutter speed and aperture.

Mode P: Program AE

Let the camera choose shutter speed and aperture for optimal exposure. Other values that produce the same exposure can be selected with program shift.

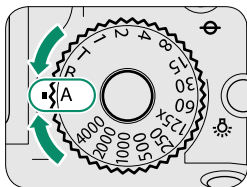

Shutter speed: Select A (auto).

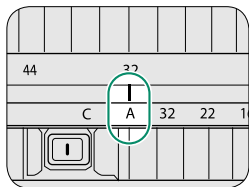
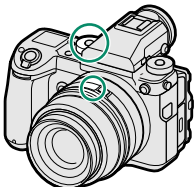

Aperture: Select A (auto).

Set shutter speed and aperture to **A** (auto) and confirm that **P** appears in the display.

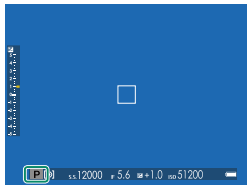

! If the subject is outside the metering range of the camera, the shutter speed and aperture displays will show “-- --”.

🔧 To use the shutter speed dial, press the dial lock release and rotate the dial to the desired setting.

Program Shift

If desired, you can rotate the rear command dial to select other combinations of shutter speed and aperture without altering exposure (program shift).

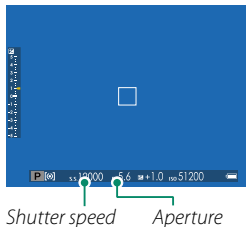

⚠ Program shift is not available during movie recording or if the flash supports TTL auto or an auto option is selected for **IMAGE QUALITY SETTING > DYNAMIC RANGE**.

🔄 To cancel program shift, turn the camera off.

Mode S: Shutter-Priority AE

Choose a shutter speed and let the camera adjust aperture for optimal exposure.

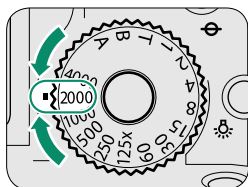

Shutter speed: Choose a speed.

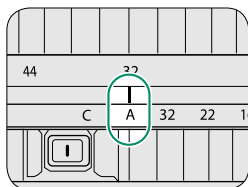
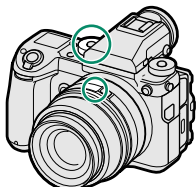

Aperture: Select A (auto).

Set aperture to **A** (auto) and use the shutter speed dial to choose a shutter speed. **S** will appear in the display.

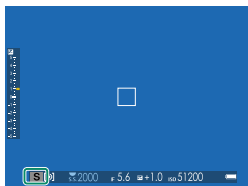

! If the correct exposure cannot be achieved at the selected shutter speed, aperture will be displayed in red. If the subject is outside the metering range of the camera, the aperture display will show "— — —".

📄 To use the shutter speed dial, press the dial lock release and rotate the dial to the desired setting (the dial can be used even while the shutter button is pressed halfway). Shutter speed can also be adjusted in increments of $\frac{1}{2}$ EV by rotating the rear command dial.

Time (T)

Rotate the shutter speed dial to T (time) to choose slow shutter speeds for long time-exposures. Use of a tripod is recommended to prevent the camera moving during the exposure.

- 1 Rotate the shutter speed dial to T.

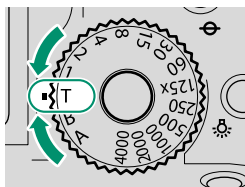

- 2 Rotate the rear command dial to choose a shutter speed.

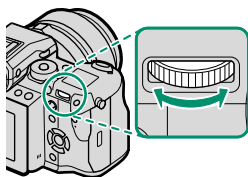

- 3 Press the shutter button all the way down to take a picture at the selected shutter speed. A count-down timer will be displayed while the exposure is in progress.

 To reduce “noise” (mottling) in long time-exposures, select **ON** for **IMAGE QUALITY SETTING > LONG EXPOSURE NR.** Note that this may increase the time needed to record images after shooting.

Bulb (B)

Select a shutter speed of **B** (bulb) for long time-exposures in which you open and close the shutter manually. Use of a tripod is recommended to prevent the camera moving during the exposure.

- 1 Rotate the shutter speed dial to **B**.

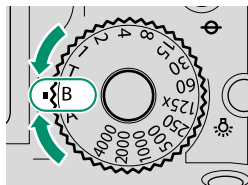

- 2 Press the shutter button all the way down. The shutter will remain open for up to 60 minutes while the shutter button is pressed; the display shows the time elapsed since the exposure started.

 Selecting an aperture of **A** fixes shutter speed at 30 s.

To reduce “noise” (mottling) in long time-exposures, select **ON** for  **IMAGE QUALITY SETTING > LONG EXPOSURE NR**. Note that this may increase the time needed to record images after shooting.

Using a Remote Release

An optional RR-90 remote release can be used for long time-exposures. The RR-90 connects via the Micro USB (Micro-B) USB 2.0 connector.

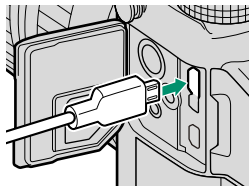

Alternatively, electronic releases from third-party suppliers can be connected via the remote release connector (ø2.5 mm 3-pole mini jack).

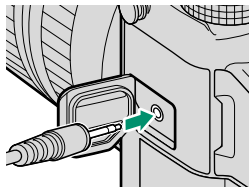

Mode A: Aperture-Priority AE

Choose an aperture and let the camera adjust shutter speed for optimal exposure.

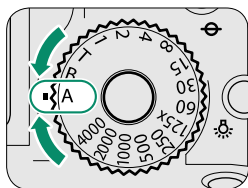

Shutter speed: Select A (auto).

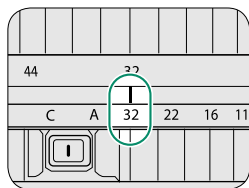
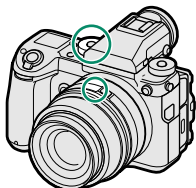

Aperture: Choose an aperture.

Rotate the shutter speed dial to A (auto), and rotate the lens aperture ring to adjust aperture as desired. A will appear in the display.

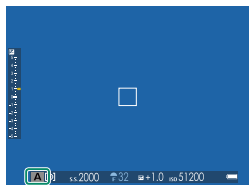

! If the correct exposure cannot be achieved at the selected aperture, shutter speed will be displayed in red. If the subject is outside the metering range of the camera, the shutter speed display will show “— —”.

📄 To use the shutter speed dial, press the dial lock release and rotate the dial to the desired setting.

Aperture can be adjusted even while the shutter button is pressed halfway.

Previewing Depth of Field

When **PREVIEW DEPTH OF FIELD** is assigned to a function button, pressing the button displays a  icon and stops aperture down to the selected setting, allowing depth of field to be previewed in the display.



 Depth of field can also be previewed using the depth-of-field indicator in the standard display. Press **DISP/BACK** to cycle through display modes until standard indicators are displayed. In autofocus mode, the depth-of-field indicator is displayed when the shutter button is pressed halfway.



Depth of field

Use the  **AF/MF SETTING > DEPTH-OF-FIELD SCALE** option to choose how depth of field is displayed. Choose **FILM FORMAT BASIS** to help you make practical assessments of depth of field for pictures that will be viewed as prints and the like, **PIXEL BASIS** to help you assess depth of field for pictures that will be viewed at high resolutions on computers or other electronic displays.

Mode M: Manual Exposure

Alter exposure from that selected by the camera.

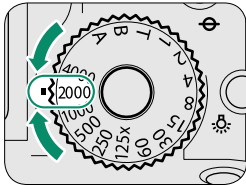

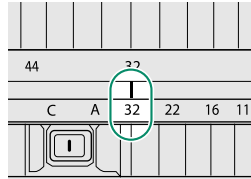
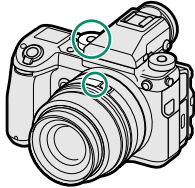

Shutter speed: Choose a speed.

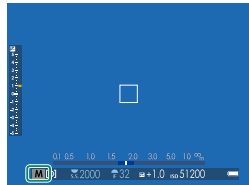

Aperture: Choose an aperture.

Set shutter speed to a value other than A, and rotate the lens aperture ring to choose the aperture. M will appear in the display.



 To use the shutter speed dial, press the dial lock release and rotate the dial to the desired setting. Shutter speed can be adjusted in increments of $\frac{1}{3}$ EV by rotating the rear command dial.

Exposure Preview

To preview exposure in the LCD monitor, select an option other than **OFF** for **SCREEN SET-UP > PREVIEW EXP./WB IN MANUAL MODE**. Select **OFF** when using the flash or on other occasions on which exposure may change when the picture is taken.

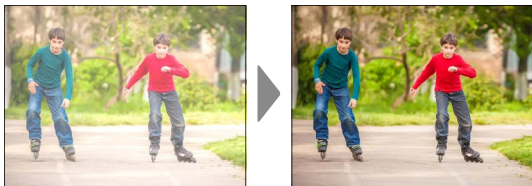

Autofocus

Take pictures using autofocus.

- 1 Rotate the focus mode selector to **S** or **C** (📖 63).

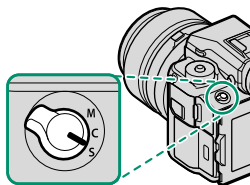

- 2 Use **AF/MF SETTING > AF MODE** to choose an AF mode (📖 65).
- 3 Choose the position and size of the focus frame (📖 67).

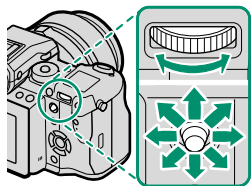

- 4 Take pictures.



For information on the autofocus system, visit:
<http://fujifilm-x.com/af/en/index.html>

Focus Mode

Use the focus mode selector to choose how the camera focuses.

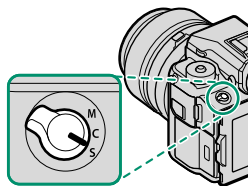

Choose from the following options:

Mode	Description
S (AF-S)	Single AF: Focus locks while the shutter button is pressed halfway. Choose for stationary subjects.
C (AF-C)	Continuous AF: Focus is continually adjusted to reflect changes in the distance to the subject while the shutter button is pressed halfway. Use for subjects that are in motion. Eye-detection AF is not available.
M (manual)	Manual: Focus manually using the lens focus ring. Choose for manual control of focus or in situations in which the camera is unable to focus using autofocus (📖 71).

 Regardless of the option selected, manual focus will be used when the lens is in manual focus mode.

If **ON** is selected for  **AF/MF SETTING** > **PRE-AF**, focus will be adjusted continuously in modes **S** and **C** even when the shutter button is not pressed.

The Focus Indicator

The focus indicator turns green when the subject is in focus and blinks white when the camera is unable to focus. Brackets (“ ”) indicate that the camera is focusing and are displayed continuously in mode **C**. **MF** is displayed in manual focus mode.

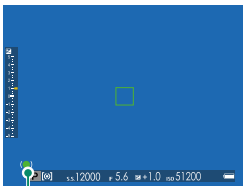



Focus indicator

Autofocus Options (AF Mode)





Choose how the camera focuses in modes **S** and **C**.

- 1 Press **MENU/OK** and go to the shooting menu.
- 2 Select **AF/MF SETTING > AF MODE**.
- 3 Choose an AF mode.



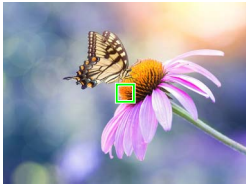

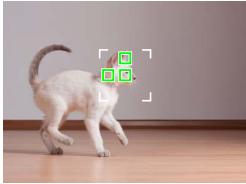
 This feature can also be accessed via shortcuts ( 176).

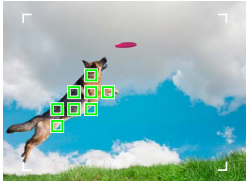
How the camera focuses depends on the focus mode.

Focus Mode **S** (AF-S)

Option	Description	Sample image
 SINGLE POINT	Camera focuses on subject in selected focus point. Use for pin-point focus on selected subject.	
 ZONE	Camera focuses on subject in selected focus zone. Focus zones include multiple focus points, making it easier to focus on subjects in motion.	
 WIDE/TRACKING	Camera focuses automatically on high-contrast subjects; display shows areas in focus.	

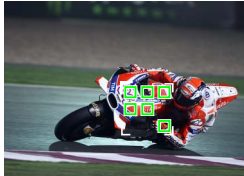
Focus Mode C (AF-C)

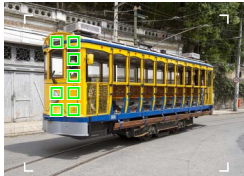
Option	Description	Sample image
 SINGLE POINT	Focus tracks subject at selected focus point. Use for subjects moving toward or away from camera.	
 ZONE	Focus tracks subject in selected focus zone. Use for subjects that are moving fairly predictably.	
 WIDE/TRACKING	Focus tracks subjects moving through wide area of frame.	

Focus-Point Selection

Choose a focus point for autofocus.

Viewing the Focus-Point Display

- 1 Press **MENU/OK** and go to the shooting menu.
- 2 Select **AF/MF SETTING > FOCUS AREA** to view the focus-point display.
- 3 Use the focus stick and rear command dial to choose a focus area.

Selecting a Focus Point

Use touch controls or the focus stick (focus lever) to choose the focus point and the rear command dial to choose the size of the focus frame. The procedure varies with the option selected for AF mode.

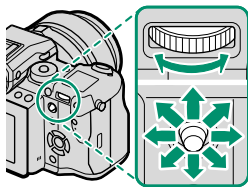







AF mode	Focus stick		Rear command dial	
	Tilt	Press	Rotate	Press
	Select focus point	Select center focus point	Choose from 6 frame sizes	Restore original size
			Choose from 3 frame sizes	
			—	

Manual focus-point selection is not available when **WIDE/TRACKING** is selected in focus mode **S**.

The Focus-Point Display

The focus-point display varies with the option selected for AF mode.

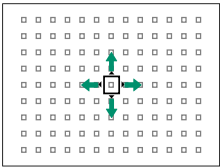
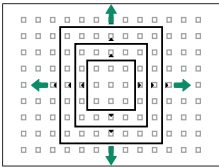
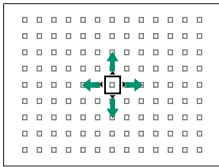
 Focus frames are shown by small squares (□), focus zones by the large squares.

AF mode		
 SINGLE POINT	 ZONE	 WIDE/TRACKING
		
<p>Number of points available can be selected using  AF/MF SETTING > NUMBER OF FOCUS POINTS.</p>	<p>Choose from zones with 7 × 7, 5 × 5, or 3 × 3 focus points.</p>	<p>Position focus frame over subject and press MENU/OK.</p>

Autofocus

Although the camera boasts a high-precision autofocus system, it may be unable to focus on the subjects listed below.

- Very shiny subjects such as mirrors or car bodies.
- Subjects photographed through a window or other reflective object.
- Dark subjects and subjects that absorb rather than reflect light, such as hair or fur.
- Insubstantial subjects, such as smoke or flame.
- Subjects that show little contrast with the background.
- Subjects positioned in front of or behind a high-contrast object that is also in the focus frame (for example, a subject photographed against a backdrop of highly contrasting elements).

Checking Focus

To zoom in on the current focus area for precise focus, press the control to which focus zoom has been assigned (at default settings, the center of the rear command dial). Press the control again to cancel zoom.

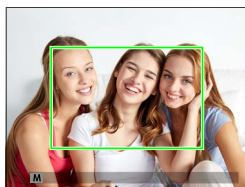
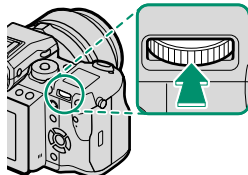

Normal display



Focus zoom

 In focus mode **S**, zoom can be adjusted by rotating the rear command dial. Focus zoom is not available in focus mode **C** or when **AF/MF SETTING > PRE-AF** is on or an option other than **SINGLE POINT** is selected for **AF MODE**.



To assign focus zoom to a control, select **FOCUS CHECK** for **BUTTON/DIAL SETTING > FUNCTION (Fn) SETTING**.

Touch Focus Controls

Use the touch screen to focus when taking photographs.

Tap the touch screen mode indicator in the shooting display to cycle through the following touch-screen modes:



Mode	Description
AF 	Tap the display to select a focus point and lock focus. The shutter can be released by pressing the shutter button all the way down.
AREA 	Tap the display to move the focus frame to the selected point. The selected point will be used for focus and focus zoom.
OFF 	Touch controls off.

 Touch control settings can be adjusted using **AF/MF SETTING > TOUCH SCREEN MODE**. To disable touch controls and hide the touch screen mode indicator, select **OFF** for **BUTTON/DIAL SETTING > TOUCH SCREEN SETTING**.

Manual Focus

Adjust focus manually.

- 1 Rotate the focus mode selector to M.

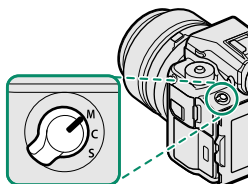

MF will appear in the display.

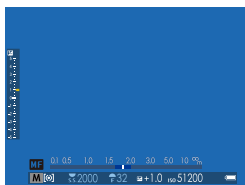

- 2 Focus manually using the lens focus ring. Rotate the ring left to reduce the focus distance, right to increase.

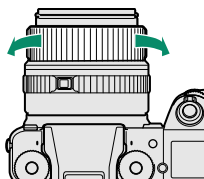

- 3 Take pictures.

Use **FUNCTION/DIAL SETTING > FOCUS RING** to reverse the direction of rotation of the focus ring.

Regardless of the option selected, manual focus will be used when the lens is in manual focus mode.

Quick Focus

To use autofocus to focus on the subject in the selected focus area, press the button to which focus lock or **AF-ON** has been assigned (the size of the focus area can be chosen with the rear command dial). In manual focus mode, you can use this feature to quickly focus on a chosen subject using either single or continuous AF according to the option chosen for  **AF/MF SETTING > INSTANT AF SETTING**.

Checking Focus

A variety of options are available for checking focus in manual focus mode.

The Manual Focus Indicator

The manual focus indicator indicates how closely the focus distance matches the distance to the subject in the focus brackets. The white line indicates the distance to the subject in the focus area (in meters or feet according to the option selected for **SCREEN SET-UP > FOCUS SCALE UNITS** in the set-up menu), the blue bar the depth of field, or in other words the distance in front of and behind the subject that appears to be in focus.

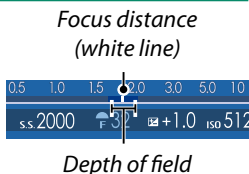

Focus Zoom

If **ON** is selected for **AF/MF SETTING > FOCUS CHECK**, the camera will automatically zoom in on the selected focus area when the focus ring is rotated.

If **STANDARD** or **FOCUS PEAK HIGHLIGHT** is selected for **AF/MF SETTING > MF ASSIST**, zoom can be adjusted by rotating the rear command dial.

Focus Peaking

Select **FOCUS PEAK HIGHLIGHT** for **AF/MF SETTING > MF ASSIST** to highlight high-contrast outlines. When focusing, rotate the focus ring until the subject is highlighted.



The **MF ASSIST** menu can be displayed by pressing and holding the center of the rear command dial.

ISO Sensitivity

Adjust the camera's sensitivity to light.

Press the sensitivity dial lock release, rotate the dial to the desired setting, and press the release again to lock the dial in place.

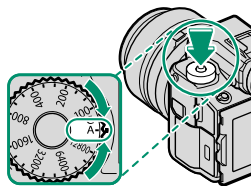

Option	Description
A (auto)	Sensitivity is automatically adjusted in response to shooting conditions according to option chosen for SHOOTING SETTING > ISO AUTO SETTING . Choose from AUTO1 , AUTO2 , and AUTO3 .
C (command)	Sensitivity can be set by rotating the front command dial. Choose from values of from 100 to 12800 or select "extended" values of ISO 50 or of ISO 25600 or higher.
12800–100	Adjust sensitivity manually. Selected value is shown in display.

Adjusting Sensitivity

High values can be used to reduce blur when lighting is poor, while lower values allow slower shutter speeds or wider apertures in bright light; note, however, that mottling may appear in pictures taken at high sensitivities.

Auto Sensitivity (A)

Use  **SHOOTING SETTING > ISO AUTO SETTING** to choose the base sensitivity, maximum sensitivity, and minimum shutter speed for the **A** position on the sensitivity dial. Settings for **AUTO1**, **AUTO2**, and **AUTO3** can be stored separately; the defaults are shown below.

Option	Default		
	AUTO1	AUTO2	AUTO3
DEFAULT SENSITIVITY		100	
MAX. SENSITIVITY	800	1600	3200
MIN. SHUTTER SPEED		1/60 SEC	

The camera automatically chooses a sensitivity between the default and maximum values; sensitivity is only raised above the default value if the shutter speed required for optimal exposure would be slower than the value selected for **MIN. SHUTTER SPEED**.

 If the value selected for **DEFAULT SENSITIVITY** is higher than that selected for **MAX. SENSITIVITY**, **DEFAULT SENSITIVITY** will be set to the value selected for **MAX. SENSITIVITY**.





The camera may select shutter speeds slower than **MIN. SHUTTER SPEED** if pictures would still be underexposed at the value selected for **MAX. SENSITIVITY**.

Metering

Choose how the camera meters exposure.

SHOOTING SETTING > PHOTOMETRY offers a choice of the following metering options:

! The selected option will only take effect when **AF/MF SETTING > FACE/EYE DETECTION SETTING** is **FACE OFF/EYE OFF**.

Mode	Description
 (spot)	The camera meters lighting conditions in an area at the center of the frame equivalent to 2% of the total. Recommended with backlit subjects and in other cases in which the background is much brighter or darker than the main subject.
 (center-weighted)	The camera meters the entire frame but assigns the greatest weight to the area at the center.
 (multi)	The camera instantly determines exposure based on an analysis of composition, color, and brightness distribution. Recommended in most situations.
 (average)	Exposure is set to the average for the entire frame. Provides consistent exposure across multiple shots with the same lighting, and is particularly effective for landscapes and portraits of subjects dressed in black or white.

Exposure Compensation



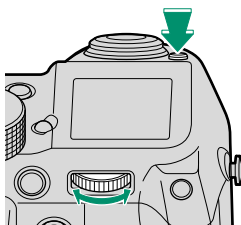

Adjust exposure.

Hold the  button and rotate the rear command dial until the desired value is displayed in the viewfinder or LCD monitor.



 The amount of compensation available varies with the shooting mode.

The Button

If **ON/OFF SWITCH** is selected for ** BUTTON/DIAL SETTING > EXPO. COMP. BUTTON SETTING**, exposure compensation can be set by pressing the  button once, rotating the rear command dial, and then pressing the  button again. Exposure compensation can be assigned to other controls using ** BUTTON/DIAL SETTING > FUNCTION (Fn) SETTING**.

Focus/Exposure Lock

Compose photographs with off-center subjects.

- 1 Focus:** Position the subject in the focus frame and press the shutter button halfway to lock focus and exposure. Focus and exposure will remain locked while the shutter button is pressed halfway (AF/AE lock).

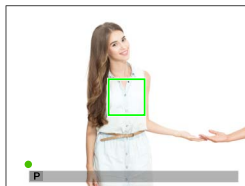

- 2 Recompose:** Keep the shutter button pressed halfway.

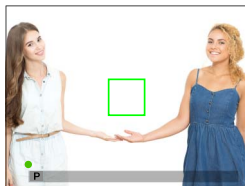

- 3 Shoot:** Press the button all the way down.



Focus lock using the shutter button is only available when **ON** is selected for **SHOOTING MODE** > **SHOOTER AF**, **SHOOTER AE**.

The AF-L and AE-L Buttons

Focus and exposure can also be locked using function buttons. At default settings, the **Fn4** button locks focus, the **Fn5** button exposure. Focus and/or exposure will remain locked while the button is pressed, whether or not the shutter button is pressed halfway.

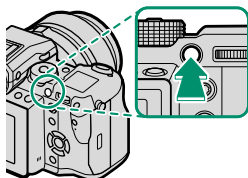

Fn4 button
(focus lock)

The roles of the buttons can be changed using the following **▶ BUTTON/DIAL SETTING** options:

- **FUNCTION (Fn) SETTING:** Choose the roles played by the function buttons.
- **AE/AF-LOCK MODE:** If **AE&AF ON/OFF SWITCH** is selected for **AE/AF-LOCK MODE**, focus and/or exposure lock when the button is pressed and remain locked until the button is pressed again.

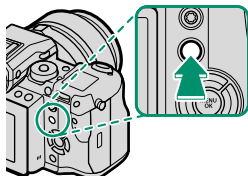

Fn5 button
(exposure lock)

BKT Bracketing

Automatically vary settings over a series of pictures.

Press the drive button and choose from the options below.

AE BKT

Use  **SHOOTING SETTING** > **AE BKT SETTING** to choose the bracketing amount and number of shots. Each time the shutter button is pressed, the camera will take the specified number of shots: one using the metered value for exposure and the others over- or under-exposed by multiples of the selected bracketing amount.

 Regardless of the bracketing amount, exposure will not exceed the limits of the exposure metering system.

ISO BKT

Select a bracketing amount (± 1 , $\pm \frac{2}{3}$, or $\pm \frac{1}{3}$). Each time the shutter is released, the camera will take a picture at the current sensitivity and process it to create two additional copies, one with sensitivity raised and the other with sensitivity lowered by the selected amount.

FILM SIMULATION BKT

Each time the shutter is released, the camera takes one shot and processes it to create copies with different film simulation settings, chosen using  **SHOOTING SETTING** > **FILM SIMULATION BKT**.

WB | WHITE BALANCE BKT

Select a bracketing amount (± 1 , ± 2 , or ± 3). Each time the shutter is released, the camera takes one shot and processes it to create three copies: one at the current white balanced setting, one with fine-tuning increased by the selected amount, and another with fine-tuning decreased by the selected amount.

DR | DYNAMIC RANGE BKT

Each time the shutter button is pressed, the camera takes three shots with different dynamic ranges: 100% for the first, 200% for the second, and 400% for the third.



While dynamic range bracketing is in effect, sensitivity will be restricted to a minimum of ISO 400 (or to a minimum of ISO 100 to 400 when an auto option is selected for sensitivity); the sensitivity previously in effect is restored when bracketing ends.



Continuous Shooting (Burst Mode)

Capture motion in a series of pictures.

Press the drive button and select **CONTINUOUS**. The camera will take pictures while the shutter button is pressed; shooting ends when the shutter button is released or the memory card is full.

If file numbering reaches 999 before shooting is complete, the remaining pictures will be recorded to a new folder.

Burst shooting may not begin if the space available on the memory card is insufficient.

Frame rate varies with the subject, shutter speed, sensitivity, and focus mode. Frame rates may slow and recording times increase as more shots are taken. The flash may or may not fire, depending on shooting conditions.

Exposure

To vary exposure with each shot, select **OFF** for **BUTTON/DIAL SETTING > SHUTTER AE**.

Depending on such factors as aperture, sensitivity, and exposure compensation, exposure may not be adjusted automatically.



Multiple Exposures

Create a photograph that combines two exposures.

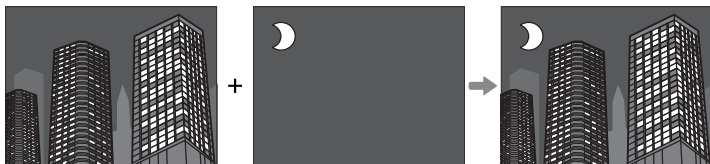

1 Press the drive button and select  **MULTIPLE EXPOSURE**.

2 Take the first shot.

3 Press **MENU/OK**. The first shot will be shown superimposed on the view through the lens and you will be prompted to take the second shot.



To return to Step 2 and retake the first shot, press the selector left. To save the first shot and exit without creating a multiple exposure, press **DISP/BACK**.



4 Take the second shot, using the first frame as a guide.



5 Press **MENU/OK** to create the multiple exposure, or press the selector left to return to Step 4 and retake the second shot.



Multiple exposures cannot be recorded via tethered shooting ( 174).

6

The Shooting Menus



IMAGE QUALITY SETTING

Adjust image quality settings.

To display image quality settings, press **MENU/OK** in the shooting display and select the **IQ** (IMAGE QUALITY SETTING) tab.

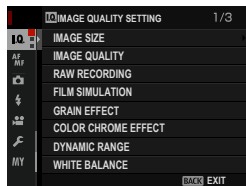

The options available vary with the shooting mode selected.

IMAGE SIZE

Choose the size and aspect ratio at which still pictures are recorded.

Option	Image size	Option	Image size
L 4:3	8256 × 6192	S 4:3	4000 × 3000
L 3:2	8256 × 5504	S 3:2	4000 × 2664
L 16:9	8256 × 4640	S 16:9	4000 × 2248
L 1:1	6192 × 6192	S 1:1	2992 × 2992
L 65:24	8256 × 3048	S 65:24	4000 × 1480
L 5:4	7744 × 6192	S 5:4	3744 × 3000
L 7:6	7232 × 6192	S 7:6	3504 × 3000



IMAGE SIZE is not reset when the camera is turned off or another shooting mode is selected.

IMAGE QUALITY

Choose a file format and compression ratio. Select **SUPER FINE** (minimum compression), **FINE** (low compression), or **NORMAL** (high compression) to record JPEG images, **RAW** to record RAW images, or **SUPER FINE+RAW**, **FINE+RAW**, or **NORMAL+RAW** to record both JPEG and RAW images. With JPEG images, the lower the compression ratio, the higher the quality of the image, while higher compression ratios allow more images to be stored in the same amount of memory.

The Function Buttons

To toggle RAW image quality on or off for a single shot, assign **RAW** to a function button (📖 182). If a JPEG option is currently selected for image quality, pressing the button temporarily selects the equivalent JPEG+RAW option. If a JPEG+RAW option is currently selected, pressing the button temporarily selects the equivalent JPEG option, while if **RAW** is selected, pressing the button temporarily selects **FINE**. Taking a picture or pressing the button again restores the previous setting.











RAW RECORDING

Choose whether to compress RAW images.

Option	Description
UNCOMPRESSED	RAW images are not compressed.
LOSSLESS COMPRESSED	RAW images are compressed using a reversible algorithm that reduces file size with no loss of image data. The images can be viewed in RAW FILE CONVERTER EX 2.0 or other software that supports "lossless" RAW compression (📖 212).

FILM SIMULATION

Simulate the effects of different kinds of film, including black-and-white (with or without color filters). Choose a palette according to your subject and creative intent.

Option	Description
 PROVIA/STANDARD	Standard color reproduction. Suited to a wide range of subjects, from portraits to landscapes.
 Velvia/VIVID	A high-contrast palette of saturated colors, suited to nature photos.
 ASTIA/SOFT	Enhances the range of hues available for skin tones in portraits while preserving the bright blues of daylight skies. Recommended for outdoor portrait photography.
 CLASSIC CHROME	Soft color and enhanced shadow contrast for a calm look.
 PRO Neg. Hi	Offers slightly more contrast than  PRO Neg. Std. Recommended for outdoor portrait photography.
 PRO Neg. Std	A soft-toned palette. The range of hues available for skin tones is enhanced, making this a good choice for studio portrait photography.
 ACROS*	Take black-and-white photos with rich gradation and outstanding sharpness.
 MONOCHROME*	Take pictures in standard black and white.
 SEPIA	Take pictures in sepia.

* Available with yellow (**Ye**), red (**R**), and green (**G**) filters, which deepen shades of gray corresponding to hues complementary to the selected color. The yellow (**Ye**) filter deepens purples and blues and the red (**R**) filter blues and greens. The green (**G**) filter deepens reds and browns, including skin tones, making it a good choice for portraits.

 Film simulation options can be combined with tone and sharpness settings.

Film simulation settings can also be accessed via shortcuts ( 176).

For more information, visit: <http://fujifilm-x.com/en/x-stories/the-world-of-film-simulation-episode-1/>

GRAIN EFFECT

Add a film grain effect. Select an amount (**STRONG** or **WEAK**) or choose **OFF** to turn film grain off.

Options		
STRONG	WEAK	OFF

COLOR CHROME EFFECT

Deepen colors in shadows. Select an amount (**STRONG** or **WEAK**) or choose **OFF** to turn the effect off.

Options		
STRONG	WEAK	OFF

 **COLOR CHROME EFFECT** is not available during bracketing or burst photography.

DYNAMIC RANGE

Control contrast. Choose lower values to increase contrast when shooting indoors or under overcast skies, higher values to reduce loss of detail in highlights and shadows when photographing high-contrast scenes. Higher values are recommended for scenes that include both sunlight and deep shade, for such high-contrast subjects as sunlight on water, brightly-lit autumn leaves, and portraits taken against a blue sky, and for white objects or people wearing white; note, however, that mottling may appear in pictures taken at higher values.







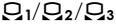

Options			
AUTO	#100 100%	#200 200%	#400 400%

 If **AUTO** is selected, the camera will automatically choose either **#100 100%** or **#200 200%** according to the subject and shooting conditions. Shutter speed and aperture will be displayed when the shutter button is pressed halfway.

#200 200% is available at sensitivities of ISO 200 and above, **#400 400%** at sensitivities of ISO 400 and above.

WHITE BALANCE

For natural colors, choose a white balance option that matches the light source.

Option	Description
AUTO	White balance is adjusted automatically.
 $\text{W}_1/\text{W}_2/\text{W}_3$	Measure a value for white balance.
	Choose a color temperature.
	For subjects in direct sunlight.
	For subjects in the shade.
	Use under "daylight" fluorescent lights.
	Use under "warm white" fluorescent lights.
	Use under "cool white" fluorescent lights.
	Use under incandescent lighting.
	Reduces the blue cast typically associated with underwater lighting.

 Results vary with shooting conditions. Play pictures back after shooting to check colors.

White balance is adjusted for flash lighting only in **AUTO** and  modes. Turn the flash off using other white balance options.

White balance options can also be accessed via shortcuts ( 176).

Fine-Tuning White Balance

Pressing **MENU/OK** after selecting a white balance option displays the dialog shown at right; use the selector to fine-tune white balance or press **DISP/BACK** to exit without fine-tuning.

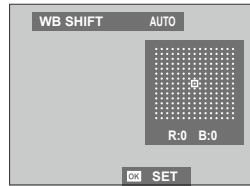

Custom White Balance

Choose Ω_1 , Ω_2 , or Ω_3 to adjust white balance for unusual lighting conditions. White balance measurement options will be displayed; frame a white object so that it fills the display and press the shutter button all the way down to measure white balance (to select the most recent custom value and exit without measuring white balance, press **DISP/BACK**, or press **MENU/OK** to select the most recent value and display the fine-tuning dialog).

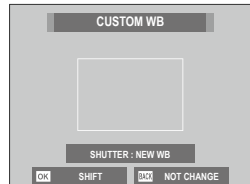

- If **“COMPLETED!”** is displayed, press **MENU/OK** to set white balance to the measured value.
- If **“UNDER”** is displayed, raise exposure compensation and try again.
- If **“OVER”** is displayed, lower exposure compensation and try again.

K: Color Temperature

Selecting **K** in the white balance menu displays a list of color temperatures; highlight a color temperature and press **MENU/OK** to select the highlighted option and display the fine-tuning dialog.

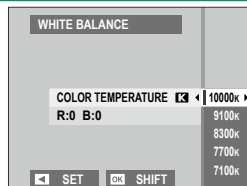

Color Temperature

Color temperature is an objective measure of the color of a light source, expressed in Kelvin (K). Light sources with a color temperature close to that of direct sunlight appear white; light sources with a lower color temperature have a yellow or red cast, while those with a higher color temperature are tinged with blue. You can match color temperature to the light source, or choose options that differ sharply from the color of the light source to make pictures “warmer” or “colder.”

HIGHLIGHT TONE

Adjust the appearance of highlights. Choose from seven options between +4 and -2.

Options						
+4	+3	+2	+1	0	-1	-2

SHADOW TONE

Adjust the appearance of shadows. Choose from seven options between +4 and -2.

Options						
+4	+3	+2	+1	0	-1	-2

COLOR

Adjust color density. Choose from nine options between +4 and -4.

Options								
+4	+3	+2	+1	0	-1	-2	-3	-4

SHARPNESS

Sharpen or soften outlines. Choose from nine options between +4 and -4.

Options								
+4	+3	+2	+1	0	-1	-2	-3	-4

NOISE REDUCTION

Reduce noise in pictures taken at high sensitivities. Choose from nine options between +4 and -4.

Options								
+4	+3	+2	+1	0	-1	-2	-3	-4

LONG EXPOSURE NR

Select **ON** to reduce mottling in long time-exposures.

Options	
ON	OFF

LENS MODULATION OPTIMIZER

Select **ON** to improve definition by adjusting for diffraction and the slight loss of focus at the periphery of the lens.

Options	
ON	OFF

COLOR SPACE

Choose the gamut of colors available for color reproduction.

Option	Description
sRGB	Recommended in most situations.
Adobe RGB	For commercial printing.

PIXEL MAPPING

Use this option if you notice bright spots in your pictures.

- 1 Press **MENU/OK** in the shooting display and select the  **IMAGE QUALITY SETTING** tab.
- 2 Highlight **PIXEL MAPPING** and press **MENU/OK** to perform pixel mapping. Processing may take a few seconds.

 Results are not guaranteed.

Be sure the battery is fully charged before beginning pixel mapping.

Pixel mapping is not available when the camera temperature is elevated.

SELECT CUSTOM SETTING

Recall settings saved with **EDIT/SAVE CUSTOM SETTING**. Settings can be recalled from any of the seven custom settings banks.

Banks						
CUSTOM 1	CUSTOM 2	CUSTOM 3	CUSTOM 4			
	CUSTOM 5	CUSTOM 6	CUSTOM 7			

EDIT/SAVE CUSTOM SETTING

Save up to 7 sets of custom camera settings for commonly-encountered situations. Saved settings can be recalled using **IMAGE QUALITY SETTING > SELECT CUSTOM SETTING**.

- 1 Press **MENU/OK** in shooting mode to display the shooting menu. Select the **IMAGE QUALITY SETTING** tab, then highlight **EDIT/SAVE CUSTOM SETTING** and press **MENU/OK**.
- 2 Highlight a custom settings bank and press **MENU/OK** to select.

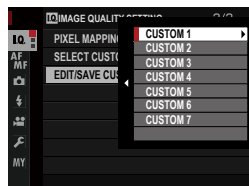

- 3 Adjust the following as desired:
 - DYNAMIC RANGE
 - FILM SIMULATION
 - GRAIN EFFECT
 - COLOR CHROME EFFECT
 - WHITE BALANCE
 - HIGHLIGHT TONE
 - SHADOW TONE
 - COLOR
 - SHARPNESS
 - NOISE REDUCTION

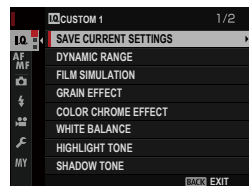

- 4 Press **DISP/BACK**. A confirmation dialog will be displayed; highlight **OK** and press **MENU/OK**.

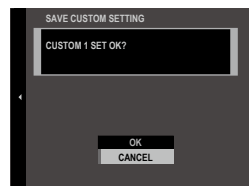

To store current camera settings in the selected bank, highlight **SAVE CURRENT SETTINGS** in Step 3 and press **MENU/OK**. Banks can be re-named using **EDIT CUSTOM NAME**.

To restore default settings for the current bank, select **RESET**.



AF/MF SETTING

Adjust focus settings.

To display focus settings, press **MENU/OK** in the shooting display and select the **AF/MF** (**AF/MF SETTING**) tab.

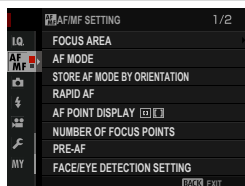

The options available vary with the shooting mode selected.

FOCUS AREA

Choose the focus area for autofocus, manual focus, and focus zoom.

AF MODE

Choose the AF mode for focus modes **S** and **C**.

Option	Description
SINGLE POINT	The camera focuses on the subject in the selected focus point. The number of focus points available can be selected using AF/MF SETTING > NUMBER OF FOCUS POINTS . Use for pin-point focus on a selected subject.
ZONE	The camera focuses on the subject in the selected focus zone. Focus zones include multiple focus points, making it easier to focus on subjects that are in motion.
WIDE/TRACKING	In focus mode C , the camera tracks focus on the subject in the selected focus point while the shutter button is pressed halfway. In focus mode S , the camera automatically focuses on high-contrast subjects; the areas in focus are shown in the display. The camera may be unable to focus on small objects or subjects that are moving rapidly.

STORE AF MODE BY ORIENTATION

Choose whether the focus mode and focus area used when the camera is in portrait orientation are stored separately from those used when the camera is in landscape orientation.

Option	Description
OFF	The same settings are used in both orientations.
FOCUS AREA ONLY	The focus area for each orientation can be selected separately.
ON	The focus mode and focus area can be selected separately.

RAPID AF

Select **ON** for faster focus times. Display quality will drop while the camera focuses.

Options	
ON	OFF

AF POINT DISPLAY

Choose whether individual focus frames are displayed when **ZONE** or **WIDE/TRACKING** is selected for  **AF/MF SETTING** > **AF MODE**.

Options	
ON	OFF

NUMBER OF FOCUS POINTS

Choose the number of focus points available for focus-point selection in manual focus mode or when **SINGLE POINT** is selected for **AF MODE**.

Option	Description
117 POINTS (9×13)	Choose from 117 focus points arranged in a 13- by 9-point grid.
425 POINTS (17×25)	Choose from 425 focus points arranged in a 25- by 17-point grid.

PRE-AF

If **ON** is selected, the camera will continue to adjust focus even when the shutter button is not pressed halfway. Note that this increases the drain on the battery.

Options	
ON	OFF

FACE/EYE DETECTION SETTING

Intelligent Face Detection sets focus and exposure for human faces anywhere in the frame, preventing the camera from focusing on the background in group portraits. Choose for shots that emphasize portrait subjects. Faces can be detected with the camera in vertical or horizontal orientation; if a face is detected, it will be indicated by a green border. If there is more than one face in the frame, the camera will select the face closest to the center; other faces are indicated by white borders. You can also choose whether the camera detects and focuses on eyes when Intelligent Face Detection is on. Choose from the following options:

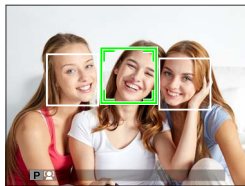

Option	Description
FACE ON/EYE OFF	Intelligent Face Detection only.
FACE ON/EYE AUTO	The camera automatically chooses which eye to focus on when a face is detected.
FACE ON/RIGHT EYE PRIORITY	The camera focuses on the right eye of subjects detected using Intelligent Face Detection.
FACE ON/LEFT EYE PRIORITY	The camera focuses on the left eye of subjects detected using Intelligent Face Detection.
FACE OFF/EYE OFF	Intelligent Face Detection and eye priority off.

 In some modes, the camera may set exposure for the frame as a whole rather than the portrait subject.

If the subject moves as the shutter button is pressed, the face may not be in the area indicated by the green border when the picture is taken.

 If the camera is unable to detect the subject's eyes because they are hidden by hair, glasses, or other objects, the camera will instead focus on faces.

Face/eye detection options can also be accessed via shortcuts ( 176).

AF+MF

If **ON** is selected in focus mode **S**, focus can be adjusted manually by rotating the focus ring while the shutter button is pressed halfway. Both standard and focus peaking MF assist options are supported.

Options	
ON	OFF

 Lenses with a focus distance indicator must be set to manual focus mode (MF) before this option can be used. Selecting MF disables the focus distance indicator. Set the focus ring to the center of the focus distance indicator, as the camera may fail to focus if the ring is set to infinity or the minimum focus distance.

 Focus peaking can be used to check focus. To enable focus peaking, select **FOCUS PEAK HIGHLIGHT** for **MF ASSIST**.

AF + MF Focus Zoom

When **ON** is selected for  **AF/MF SETTING** > **FOCUS CHECK** and **SINGLE POINT** selected for **AF MODE**, focus zoom can be used to zoom in on the selected focus area. The zoom ratio (2.5x, 4x, 8x, or 16.7x) can be selected using the rear command dial.

MF ASSIST

Choose how focus is displayed in manual focus mode.

Option	Description
STANDARD	Focus is displayed normally.
FOCUS PEAK HIGHLIGHT	The camera heightens high-contrast outlines. Choose a color and peaking level.

FOCUS CHECK

If **ON** is selected, the display will automatically zoom in on the selected focus area when the focus ring is rotated in manual focus mode.

Options	
ON	OFF

ⓘ Pressing the center of the rear command dial cancels focus zoom.

INTERLOCK SPOT AE & FOCUS AREA

Select **ON** to meter the current focus frame when **SINGLE POINT** is selected for **AF MODE** and **SPOT** is selected for **PHOTOMETRY**.

Options	
ON	OFF

INSTANT AF SETTING

Choose whether the camera focuses using single AF (**AF-S**) or continuous AF (**AF-C**) when the button to which focus lock is assigned is pressed in manual focus mode.

Options	
AF-S	AF-C

DEPTH-OF-FIELD SCALE

Choose **FILM FORMAT BASIS** to help you make practical assessments of depth of field for pictures that will be viewed as prints and the like, **PIXEL BASIS** to help you assess depth of field for pictures that will be viewed at high resolutions on computers or other electronic displays.

Options	
PIXEL BASIS	FILM FORMAT BASIS

RELEASE/FOCUS PRIORITY



Choose how the camera focuses in focus mode **AF-S** or **AF-C**.

Option	Description
RELEASE	Shutter response is prioritized over focus. Pictures can be taken when the camera is not in focus.
FOCUS	Focus is prioritized over shutter response. Pictures can be only taken when the camera is in focus.

TOUCH SCREEN MODE

Choose whether touch controls can be used for focus.

Mode	Description
AF	Tap the display to select a focus point and lock focus. The shutter can be released by pressing the shutter button all the way down.
AREA	Tap the display to move the focus frame to the selected point. The selected point will be used for focus and focus zoom.
OFF	Touch controls off.

 To disable touch controls and hide the touch screen mode indicator, select **OFF** for  **BUTTON/DIAL SETTING > TOUCH SCREEN SETTING**.

SHOOTING SETTING

Adjust shooting options.

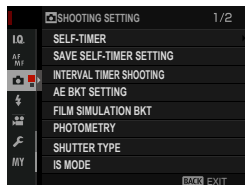

To display shooting options, press **MENU/OK** in the shooting display and select the  (**SHOOTING SETTING**) tab.



 The options available vary with the shooting mode selected.

SELF-TIMER

Choose a shutter release delay.

Option	Description
 2 SEC	The shutter is released two seconds after the shutter button is pressed. Use to reduce blur caused by the camera moving when the shutter button is pressed. The self-timer lamp blinks as the timer counts down.
 10 SEC	The shutter is released ten seconds after the shutter button is pressed. Use for photographs in which you wish to appear yourself. The self-timer lamp blinks immediately before the picture is taken.
OFF	Self-timer off.

If an option other than **OFF** is selected, the timer will start when the shutter button is pressed all the way down. The display shows the number of seconds remaining until the shutter is released. To stop the timer before the picture is taken, press **DISP/BACK**.

 Stand behind the camera when using the shutter button. Standing in front of the lens can interfere with focus and exposure.

SAVE SELF-TIMER SETTING

If **ON** is selected, the chosen self-timer setting will remain in effect after a picture is taken or the camera is turned off.

Options	
ON	OFF

INTERVAL TIMER SHOOTING

Configure the camera to take photos automatically at a preset interval.

- 1 Highlight **INTERVAL TIMER SHOOTING** in the  (**SHOOTING SETTING**) tab and press **MENU/OK**.

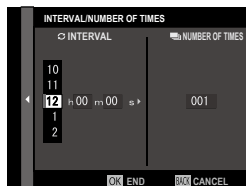



- 2 Use the selector to choose the interval and number of shots. Press **MENU/OK** to proceed.

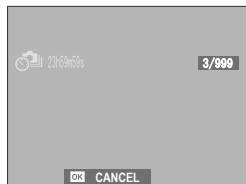

- 3 Use the selector to choose the starting time and then press **MENU/OK**. Shooting will start automatically.



 Interval timer photography cannot be used at a shutter speed of **B** (bulb) or with multiple exposure photography. In burst mode, only one picture will be taken each time the shutter is released.

 Use of a tripod is recommended.

Check the battery level before starting. We recommend using an optional AC-15V AC power adapter.

The display turns off between shots and lights a few seconds before the next shot is taken. The display can be activated at any time by pressing the shutter button.

To continue shooting until the memory card is full, set the number of shots to ∞.









AE BKT SETTING

Adjust exposure bracketing settings.

Option	Description
FRAMES/ STEP SETTING	Choose the number of shots in the bracketing sequence (FRAMES) and the amount exposure is varied with each shot (STEP).
1 FRAME/ CONTINUOUS SEQUENCE SETTING	Choose whether the shots in the bracketing sequence are taken one at a time (1 FRAME) or in a single burst (CONTINUOUS).
	Choose the order in which the shots are taken.

FILM SIMULATION BKT

Choose the three film simulation types used for film simulation bracketing ( 88).





Options		
 PROVIA/STANDARD	 Velvia/VIVID	 ASTIA/SOFT
 CLASSIC CHROME	 PRO Neg. Hi	 PRO Neg. Std
 ACROS*	 MONOCHROME*	 SEPIA

* Available with yellow (**Ye**), red (**R**), and green (**G**) filters.

PHOTOMETRY

Choose how the camera meters exposure.

 The selected option will only take effect when **AF/MF SETTING** > **FACE/EYE DETECTION SETTING** is **FACE OFF/EYE OFF**.

Mode	Description
 MULTI	The camera instantly determines exposure based on an analysis of composition, color, and brightness distribution. Recommended in most situations.
 CENTER-WEIGHTED	The camera meters the entire frame but assigns the greatest weight to the area at the center.
 SPOT	The camera meters lighting conditions in an area at the center of the frame equivalent to 2% of the total. Recommended with backlit subjects and in other cases in which the background is much brighter or darker than the main subject.
 AVERAGE	Exposure is set to the average for the entire frame. Provides consistent exposure across multiple shots with the same lighting, and is particularly effective for landscapes and portraits of subjects dressed in black or white.

SHUTTER TYPE

Choose the shutter type. Choose the electronic shutter to mute the shutter sound.

Option	Description
MS MECHANICAL SHUTTER	Take pictures with the mechanical shutter.
ES ELECTRONIC SHUTTER	Take pictures with the electronic shutter.
EFCS E-FRONT CURTAIN SHUTTER	Reduces the lag between the shutter button being pressed and the start of the exposure. The mechanical shutter is used at high shutter speeds (📖 244).
MS MECHANICAL + ES ELECTRONIC	The camera chooses the mechanical or electronic shutter according to shooting conditions.
EFCS E-FRONT CURTAIN + ES ELECTRONIC	The camera chooses the electronic or electronic front curtain shutter according to shooting conditions.



If an option other than **MS MECHANICAL SHUTTER** is selected, shutter speeds faster than $\frac{1}{4000}$ s can be chosen by rotating the shutter speed dial to **4000** and then rotating the rear command dial.

 When the electronic shutter is used, distortion may be visible in shots of moving subjects and in hand-held shots taken at high shutter speeds, while banding and fog may occur in shots taken under fluorescent lights or other flickering or erratic illumination. When taking pictures with the shutter muted, respect your subjects' image rights and right to privacy.

 When the electronic shutter is used, the flash is disabled, sensitivity is restricted to values of ISO 12800–100, and long exposure noise reduction has no effect.

IS MODE

Reduce blur.

Option	Description
 CONTINUOUS	Image stabilization on.
 SHOOTING ONLY	Image stabilization enabled only when the shutter button is pressed halfway (focus mode C) or the shutter is released.
OFF	Image stabilization off;  appears in the display. Recommended when the camera is on a tripod.

 This option is available only with lenses that support image stabilization.

ISO AUTO SETTING

Choose the base sensitivity, maximum sensitivity, and minimum shutter speed for the **A** position on the sensitivity dial. Settings for **AUTO1**, **AUTO2**, and **AUTO3** can be stored separately; the defaults are shown below.

Option	Default		
	AUTO1	AUTO2	AUTO3
DEFAULT SENSITIVITY	100		
MAX. SENSITIVITY	800	1600	3200
MIN. SHUTTER SPEED	$\frac{1}{60}$ SEC		

The camera automatically chooses a sensitivity between the default and maximum values; sensitivity is only raised above the default value if the shutter speed required for optimal exposure would be slower than the value selected for **MIN. SHUTTER SPEED**.

 If the value selected for **DEFAULT SENSITIVITY** is higher than that selected for **MAX. SENSITIVITY**, **DEFAULT SENSITIVITY** will be set to the value selected for **MAX. SENSITIVITY**.

The camera may select shutter speeds slower than **MIN. SHUTTER SPEED** if pictures would still be underexposed at the value selected for **MAX. SENSITIVITY**.

MOUNT ADAPTOR SETTING

Adjust settings for lenses attached via a mount adaptor.

Shutter Select

When using lenses with an internal shutter, choose whether to use the shutter on the camera (**BODY**) or the lens (**LENS**).

⚠ This option may have no effect with some lenses.

Saved Settings

Store settings for up to 6 lenses, or choose **OFF** to disable corrections for focal length, distortion, color shading, and peripheral illumination.

Choosing a Focal Length

Use the selector to enter the focal length.

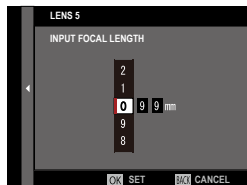

Distortion Correction

Choose from **STRONG**, **MEDIUM**, or **WEAK** options to correct **BARREL** or **PINCUSHION** distortion.

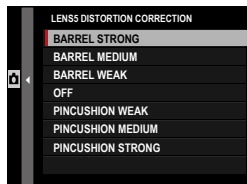

Color Shading Correction

Color (shading) variations between the center and edges of the frame can be adjusted separately for each corner.

To use color shading correction, follow the steps below.

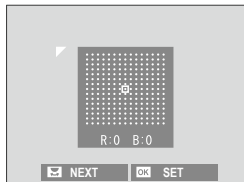



- 1 Rotate the rear command dial to choose a corner. The selected corner is indicated by a triangle.
- 2 Use the selector to adjust shading until there is no visible difference in color between the selected corner and the center of the image. Press the selector left or right to adjust colors on the cyan–red axis. Press the selector up or down to adjust colors on the blue–yellow axis.

 To determine the amount required, adjust color shading correction while taking photos of blue sky or a sheet of gray paper.

Peripheral Illumination Correction

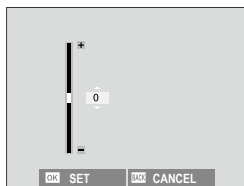
Choose from values between -5 and $+5$. Choosing positive values increases peripheral illumination, while choosing negative values reduces peripheral illumination. Positive values are recommended for vintage lenses, negative values to create the effect of images taken with an antique lens or a pinhole camera.



 To determine the amount required, adjust peripheral illumination correction while taking photos of blue sky or a sheet of gray paper.

WIRELESS COMMUNICATION

Connect to smartphones running the “FUJIFILM Camera Remote” app. The smartphone can be used to browse the images on the camera, download selected images, control the camera remotely, or upload location data to the camera.



For downloads and other information, visit:

<http://fujifilm-dsc.com/wifi/>

FLASH SETTING

Adjust flash-related settings.

To display flash-related settings, press **MENU/OK** in the shooting display and select the **⚡ (FLASH SETTING)** tab.

 The options available vary with the shooting mode selected.

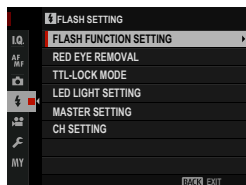

FLASH FUNCTION SETTING

Choose a flash control mode, flash mode, or sync mode or adjust the flash level. The options available vary with the flash.

 See page 197 for more information.



RED EYE REMOVAL

Remove red-eye effects caused by the flash.



Option	Description
FLASH+REMOVAL	A red-eye reduction pre-flash is combined with digital red-eye removal.
FLASH	Flash red-eye reduction only.
REMOVAL	Digital red-eye removal only.
OFF	Flash red-eye reduction and digital red-eye removal off.

 Flash red-eye reduction can be used in TTL flash control mode. Digital red-eye removal is performed only when a face is detected and is not available with RAW images.

TTL-LOCK MODE

Instead of adjusting flash level with each shot, TTL flash control can be locked for consistent results across a series of photographs.

Option	Description
LOCK WITH LAST FLASH	Flash output is locked at the value metered for the most recent photo. An error message will be displayed if no previously metered value exists.
LOCK WITH METERING FLASH	The camera emits a series of pre-flashes and locks flash output at the metered value.

 To use TTL lock, assign **TTL-LOCK** to a camera control and then use the control to enable or disable TTL lock ( 182).

Flash compensation can be adjusted while TTL lock is in effect.

LED LIGHT SETTING

Choose whether to use the flash unit's LED video light (if available) as a catchlight or AF-assist illuminator when taking photos.

Option	Role of LED video light in still photography
CATCHLIGHT	Catchlight
AF ASSIST	AF-assist illuminator
AF ASSIST+CATCHLIGHT	AF-assist illuminator and catchlight
OFF	None

 This option can also be accessed via the flash settings menu.

MASTER SETTING

Choose a flash group (A, B, or C) for the flash mounted on the camera hot shoe when it functions as a master flash controlling remote flash units via FUJIFILM wireless optical flash control, or choose **OFF** to limit master flash output to a level that does not affect the final picture.

Options			
Gr A	Gr B	Gr C	OFF

 This option can also be accessed via the flash settings menu.

CH SETTING

Choose the channel used for communication between the master flash and remote flash units when using FUJIFILM optical wireless flash control. Separate channels can be used for different flash systems or to prevent interference when multiple systems are operating in close proximity.

Options			
CH1	CH2	CH3	CH4

MOVIE SETTING

Adjust movie-recording options.



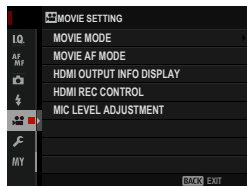





To display options for movie recording, press **MENU/OK** in the shooting display and select the  (**MOVIE SETTING**) tab.



 The options available vary with the shooting mode selected.

MOVIE MODE

Choose a frame size and rate for movie recording.

Option	Frame size	Rate
 1080/29.97P	1920 × 1080 (Full HD)	29.97 fps
 1080/25P		25 fps
 1080/24P		24 fps
 1080/23.98P		23.98 fps
 720/29.97P	1280 × 720 (HD)	29.97 fps
 720/25P		25 fps
 720/24P		24 fps
 720/23.98P		23.98 fps

MOVIE AF MODE

Choose how the camera selects the focus point for movie recording.

Option	Description
MULTI	Automatic focus-point selection.
AREA	The camera focuses on the subject in the selected focus area.

HDMI OUTPUT INFO DISPLAY

If **ON** is selected, HDMI devices to which the camera is connected will mirror the information in the camera display.

Options	
ON	OFF

HDMI REC CONTROL

Choose whether the camera sends movie start and stop signals to the HDMI device when the shutter button is pressed to start and stop movie recording.

Options	
ON	OFF

MIC LEVEL ADJUSTMENT

Adjust the recording level for the built-in and external microphones.

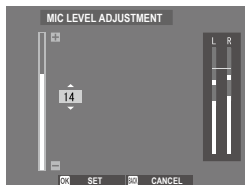

Option	Description
20—1	Choose a recording level.
OFF	Disable the microphone.

 Displays shows the peak recording level detected in a given period.

You can assign **MIC LEVEL ADJUSTMENT** to a camera control and then using the control to adjust the microphone level during recording.

Playback and the Playback Menu

7

The Playback Display

This section lists the indicators that may be displayed during playback.

! For illustrative purposes, displays are shown with all indicators lit.

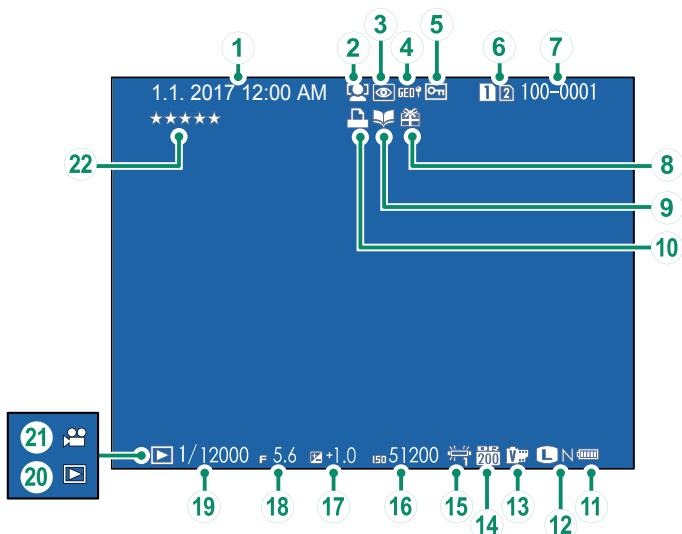

① Date and time.....	37, 147	⑫ Image size/quality.....	86, 87
② Face detection indicator.....	100	⑬ Film simulation.....	88
③ Red-eye removal indicator.....	113, 135	⑭ Dynamic range.....	89
④ Location data.....	173, 210	⑮ White balance.....	90
⑤ Protected image.....	133	⑯ Sensitivity.....	74
⑥ Card slot.....	126	⑰ Exposure compensation.....	77
⑦ Frame number.....	169	⑱ Aperture.....	53, 58, 60
⑧ Gift image.....	43	⑲ Shutter speed.....	53, 54, 60
⑨ Photobook assist indicator.....	139	⑳ Playback mode indicator.....	43
⑩ DPOF print indicator.....	141	㉑ Movie icon.....	49
⑪ Battery level.....	36	㉒ Rating.....	121

The DISP/BACK Button

The **DISP/BACK** button controls the display of indicators during playback.

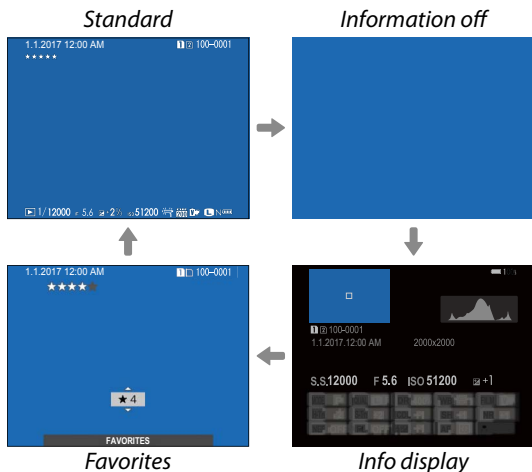
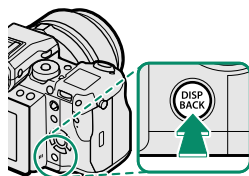

The Info Display

In the info display, you can press the selector up to cycle through a series of information and histogram displays.

Favorites: Rating Pictures

To rate the current picture, press **DISP/BACK** and press the selector up and down to select from zero to five stars.

Viewing Photo Information

The photo information display changes each time the selector is pressed up.

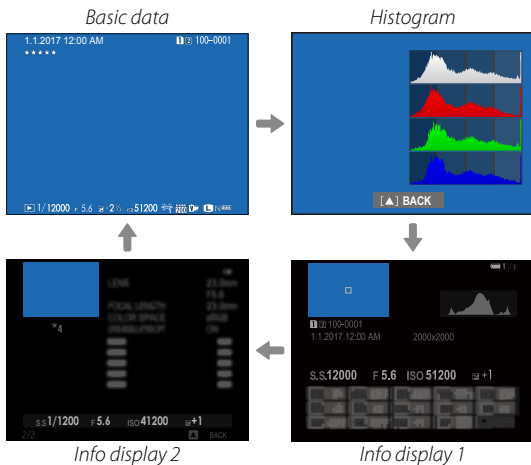
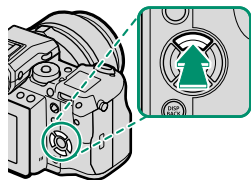
**Zooming in on the Focus Point**

Press the center of the rear command dial to zoom in on the focus point. Press again to return to full-frame playback.

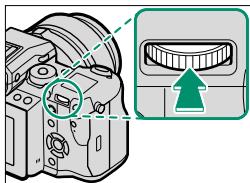

Viewing Pictures

Read this section for information on playback zoom and multi-frame playback.

Use the rear command dial to go from full-frame playback to playback zoom or multi-frame playback.

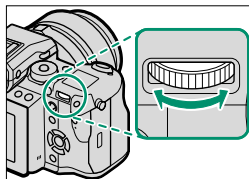

Full-frame playback



Multi-frame playback



Nine-frame view



Hundred-frame view

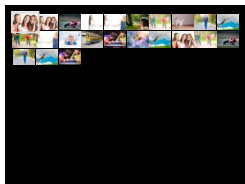

Playback zoom

DISP/BACK
MENU/OK



Medium zoom

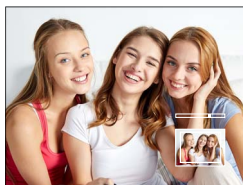

Maximum zoom



Playback Zoom

Rotate the rear command dial right to zoom in on the current picture, left to zoom out. To exit zoom, press **DISP/BACK**, **MENU/OK**, or the center of the rear command dial.

 The maximum zoom ratio varies with the option selected for **IQ IMAGE QUALITY SETTING > IMAGE SIZE**. Playback zoom is not available with cropped or resized copies saved at a size of **640**.

Scroll

When the picture is zoomed in, the selector can be used to view areas of the image not currently visible in the display.



Navigation window

Multi-Frame Playback

To change the number of images displayed, rotate the rear command dial left when a picture is displayed full frame.

 Use the selector to highlight images and press **MENU/OK** to view the highlighted image full frame. In the nine- and hundred-frame displays, press the selector up or down to view more pictures.

Playback Touch Controls

When **ON** is selected for **▶ BUTTON/DIAL SETTING > TOUCH SCREEN SETTING**, touch controls can be used for the following playback operations.

- **Swipe:** Swipe a finger across the display to view other images.

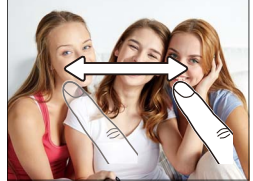

- **Pinch-out:** Place two fingers on the display and spread them apart to zoom in.



- **Pinch-in:** Place two fingers on the display and slide them together to zoom out. Zooming out when the picture is displayed full frame triggers multi-frame playback.



- **Double-tap:** Tap the display twice to zoom in on the selected area.



- **Drag:** View other areas of the image during playback zoom.



The Playback Menu

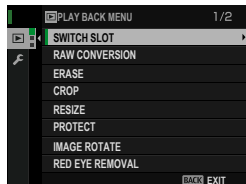

Adjust playback settings.

The playback menu is displayed when you press **MENU/OK** in playback mode.



SWITCH SLOT

Choose the card from which images will be played back.

 If two memory cards are inserted, you can press and hold the  button to choose a card for playback.

RAW CONVERSION

RAW pictures store information on camera settings separately from the data captured by the camera image sensor. Using **PLAY BACK MENU > RAW CONVERSION**, you can create JPEG copies of RAW pictures using different options for the settings listed on page 128. The original image data are unaffected, allowing a single RAW image to be processed in a multitude of different ways.

- 1 With a RAW picture displayed, press **MENU/OK** to display the playback menu.
- 2 Press the selector up or down to highlight **PLAY BACK MENU > RAW CONVERSION** and press **MENU/OK** to display settings.

 These options can also be displayed by pressing the **Q** button during playback.

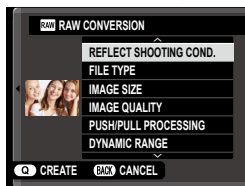

- 3 Press the selector up or down to highlight a setting and press the selector right to display options. Press the selector up or down to highlight the desired option and press **MENU/OK** to select and return to the settings list. Repeat this step to adjust additional settings.

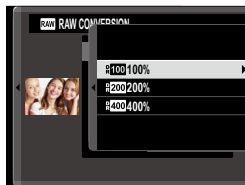

- 4 Press the **Q** button to preview the JPEG copy and press **MENU/OK** to save.

The settings that can be adjusted when converting pictures from RAW to JPEG are:

Setting	Description
REFLECT SHOOTING COND.	Create a JPEG copy using the settings in effect at the time the photo was taken.
FILE TYPE	Choose a file format.
IMAGE SIZE	Choose an image size.
IMAGE QUALITY	Adjust image quality.
PUSH/PULL PROCESSING	Adjust exposure.
DYNAMIC RANGE	Enhance details in highlights for natural contrast.
FILM SIMULATION	Simulate the effects of different types of film.
GRAIN EFFECT	Add a film grain effect.
COLOR CHROME EFFECT	Deepen colors in shadows.
WHITE BALANCE	Adjust white balance.
WB SHIFT	Fine-tune white balance.
HIGHLIGHT TONE	Adjust highlights.
SHADOW TONE	Adjust shadows.
COLOR	Adjust color density.
SHARPNESS	Sharpen or soften outlines.
NOISE REDUCTION	Process the copy to reduce mottling.
LENS MODULATION OPTIMIZER	Improve definition by adjusting for diffraction and the slight loss of focus at the periphery of the lens.
COLOR SPACE	Choose the color space used for color reproduction.

ERASE

Delete individual pictures, multiple selected pictures, or all pictures.



 Deleted pictures cannot be recovered. Protect important pictures or copy them to a computer or other storage device before proceeding.

Option	Description
FRAME	Delete pictures one at a time.
SELECTED FRAMES	Delete multiple selected pictures.
ALL FRAMES	Delete all unprotected pictures.

FRAME

- 1 Select **FRAME** for **ERASE** in the playback menu.
- 2 Press the selector left or right to scroll through pictures and press **MENU/OK** to delete (a confirmation dialog is not displayed). Repeat to delete additional pictures.

SELECTED FRAMES

- 1 Select **SELECTED FRAMES** for **ERASE** in the playback menu.
- 2 Highlight pictures and press **MENU/OK** to select or deselect (pictures in photobooks or printer orders are shown by ). Selected pictures are indicated by check marks (.
- 3 When the operation is complete, press **DISP/BACK** to display a confirmation dialog.
- 4 Highlight **OK** and press **MENU/OK** to delete the selected pictures.

ALL FRAMES

- 1 Select **ALL FRAMES** for **ERASE** in the playback menu.
- 2 A confirmation dialog will be displayed; highlight **OK** and press **MENU/OK** to delete all unprotected pictures.



Pressing **DISP/BACK** cancels deletion; note that any pictures deleted before the button was pressed cannot be recovered.

If a message appears stating that the selected images are part of a DPOF print order, press **MENU/OK** to delete the pictures.

CROP

Create a cropped copy of the current picture.

- 1 Display the desired picture.
- 2 Select **CROP** in the playback menu.
- 3 Use the rear command dial to zoom in and out and press the selector up, down, left, or right to scroll the picture until the desired portion is displayed.
- 4 Press **MENU/OK** to display a confirmation dialog.
- 5 Press **MENU/OK** again to save the cropped copy to a separate file.



Larger crops produce larger copies; all copies have an aspect ratio of 3:2. If the size of the final copy will be **640**, **YES** will be displayed in yellow.

RESIZE

Create a small copy of the current picture.

- 1 Display the desired picture.
- 2 Select **RESIZE** in the playback menu.
- 3 Highlight a size and press **MENU/OK** to display a confirmation dialog.
- 4 Press **MENU/OK** again to save the resized copy to a separate file.



The sizes available vary with the size of the original image.

PROTECT

Protect pictures from accidental deletion. Highlight one of the following options and press **MENU/OK**.

- **FRAME**: Protect selected pictures. Press the selector left or right to view pictures and press **MENU/OK** to select or deselect. Press **DISP/BACK** when the operation is complete.
- **SET ALL**: Protect all pictures.
- **RESET ALL**: Remove protection from all pictures.

 Protected pictures will be deleted when the memory card is formatted.

IMAGE ROTATE

Rotate pictures.

- 1 Display the desired picture.
- 2 Select **IMAGE ROTATE** in the playback menu.
- 3 Press the selector down to rotate the picture 90° clockwise, up to rotate it 90° counterclockwise.
- 4 Press **MENU/OK**. The picture will automatically be displayed in the selected orientation whenever it is played back on the camera.



Protected pictures cannot be rotated. Remove protection before rotating pictures.



The camera may not be able to rotate pictures created with other devices. Pictures rotated on the camera will not be rotated when viewed on a computer or on other cameras.

Pictures taken with **SCREEN SET-UP > AUTOROTATE PB** are automatically displayed in the correct orientation during playback.

RED EYE REMOVAL

Remove red-eye from portraits. The camera will analyze the image; if red-eye is detected, the image will be processed to create a copy with reduced red-eye.

- 1 Display the desired picture.
- 2 Select **RED EYE REMOVAL** in the playback menu.
- 3 Press **MENU/OK**.

 Results vary depending on the scene and the camera's success in detecting faces. Red eye cannot be removed from pictures that have already been processed using red-eye removal, which are indicated by a  icon during playback.

The amount of time needed to process the image varies with the number of faces detected.

Red eye removal cannot be performed on RAW images.

VOICE MEMO SETTING



Add a voice memo to the current photograph.

- 1 Select **ON** for **VOICE MEMO SETTING** in the playback menu.
- 2 Display a photo to which you wish to add a voice memo.
- 3 Press and hold the center of the front command dial to record the memo. Recording ends after 30 s or when you release the dial.

 The new memo will be recorded over any existing memos. Deleting the picture also deletes the memo.

Voice memos cannot be added to movies or protected pictures.

Playing Voice Memos

Pictures with voice memos are indicated by  icons during playback. To play a memo, select the picture and press the center of the front command dial; a progress bar will be displayed while the memo plays back. Volume can be adjusted by pressing **MENU/OK** to pause playback and then pressing the selector up or down to adjust the volume. Press **MENU/OK** again to resume playback. Volume can also be adjusted using  **SOUND SET-UP > PLAYBACK VOLUME**.

COPY

Copy pictures between the cards in the first and second slots.

- 1 Select **COPY** in the playback menu.
- 2 Highlight one of the following options and press the selector right:
 - **SLOT1** ➔ **SLOT2**: Copy pictures from the card in the first slot to the card in the second slot.
 - **SLOT2** ➔ **SLOT1**: Copy pictures from the card in the second slot to the card in the first slot.
- 3 Highlight one of the following options and press **MENU/OK**:
 - **FRAME**: Copy selected pictures. Press the selector left or right to view pictures and press **MENU/OK** to copy the current picture.
 - **ALL FRAMES**: Copy all pictures.

 Copying ends when the destination is full.

WIRELESS COMMUNICATION

Connect to smartphones running the “FUJIFILM Camera Remote” app. The smartphone can be used to browse the images on the camera, download selected images, control the camera remotely, or upload location data to the camera.



For downloads and other information, visit:

<http://fujifilm-dsc.com/wifi/>

PHOTOBOOK ASSIST

Create books from your favorite photos.

Creating a Photobook

1 Select **NEW BOOK** for  **PLAY BACK MENU > PHOTOBOOK ASSIST**.

2 Scroll through the images and press the selector up to select or deselect. Press **MENU/OK** to exit when the book is complete.

 Neither photographs **640** or smaller nor movies can be selected for photobooks.

The first picture selected becomes the cover image. Press the selector down to select the current image for the cover instead.

3 Highlight **COMPLETE PHOTOBOOK** and press **MENU/OK** (to select all photos for the book, choose **SELECT ALL**). The new book will be added to the list in the photobook assist menu.

 Books can contain up to 300 pictures. Books that contain no photos are automatically deleted.

Photobooks

Photobooks can be copied to a computer using MyFinePix Studio software.

Viewing Photobooks

Highlight a book in the photobook assist menu and press **MENU/OK** to display the book, then press the selector left or right to scroll through the pictures.

Editing and Deleting Photobooks

Display the photobook and press **MENU/OK**. The following options will be displayed; select the desired option and follow the on-screen instructions.

- **EDIT:** Edit the book as described in “Creating a Photobook”.
- **ERASE:** Delete the book.

PRINT ORDER (DPOF)

Create a digital “print order” for DPOF-compatible printers.

- 1 Select **PLAY BACK MENU > PRINT ORDER (DPOF)**.
- 2 Select **WITH DATE** to print the date of recording on pictures, **WITHOUT DATE** to print pictures without dates, or **RESET ALL** to remove all pictures from the print order before proceeding.
- 3 Display a picture you wish to include in or remove from the print order.
- 4 Press the selector up or down to choose the number of copies (up to 99). To remove a picture from the order, press the selector down until the number of copies is 0.

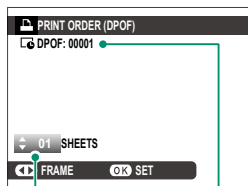

Total number
of prints

Number of copies

- 5 Repeat steps 3–4 to complete the print order.
- 6 The total number of prints is displayed in the monitor. Press **MENU/OK** to exit.

The pictures in the current print order are indicated by a  icon during playback.

Print orders can contain a maximum of 999 pictures.

If a memory card is inserted containing a print order created by another camera, a message will be displayed. Pressing **MENU/OK** cancels the print order; a new print order must be created as described above.

instax PRINTER PRINT

To print pictures to optional FUJIFILM instax SHARE printers, first select **CONNECTION SETTING > instax PRINTER CONNECTION SETTING** and enter the instax SHARE printer name (SSID) and password, then follow the steps below.

- 1 Turn the printer on.
- 2 Select **PLAY BACK MENU > instax PRINTER PRINT**. The camera will connect to the printer.

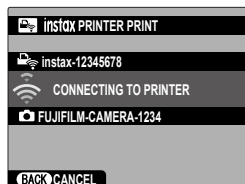

 To print a frame from a burst sequence, display the frame before selecting **instax PRINTER PRINT**.

- 3 Use the selector to display the picture you want to print, then press **MENU/OK**. The picture will be sent to the printer and printing will start.



 Pictures taken with other cameras cannot be printed.

The area printed is smaller than the area visible in the LCD monitor.

DISP ASPECT

Choose how High Definition (HD) devices display pictures with an aspect ratio of 4:3 (this option takes effect only when an HDMI cable is connected). Select 16:9 to display the image so that it fills the screen with its top and bottom cropped out, 4:3 to display the entire image with black bands at either side.

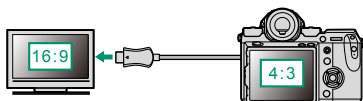

	Option	
	16:9	4:3
Display		

 Select **16:9** when viewing pictures with an aspect ratio of 16:9.

The Setup Menus

8

USER SETTING

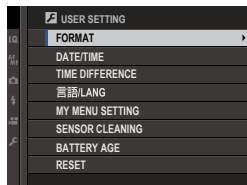

Adjust basic camera settings.

To access basic camera settings, press **MENU/OK**, select the  (SET UP) tab, and choose **USER SETTING**.



FORMAT

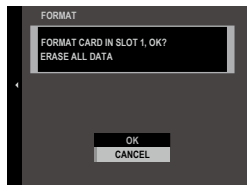

To format a memory card:

- 1 Select  **USER SETTING** > **FORMAT** in the  (SET UP) tab.
- 2 Highlight the slot containing the card you wish to format and press **MENU/OK**.
- 3 A confirmation dialog will be displayed. To format the memory card, highlight **OK** and press **MENU/OK**. To exit without formatting the memory card, select **CANCEL** or press **DISP/BACK**.



 All data—including protected pictures—will be deleted from the memory card. Be sure important files have been copied to a computer or other storage device.

Do not open the battery-chamber cover during formatting.

 The format menu can also be displayed by pressing the center of the rear command dial while pressing and holding the  button.

DATE/TIME

To set the camera clock:

- 1 Select **USER SETTING** > **DATE/TIME** in the **(SET UP)** tab.
- 2 Press the selector left or right to highlight the year, month, day, hour, or minute and press up or down to change. To change the order in which the year, month, and day are displayed, highlight the date format and press the selector up or down.
- 3 Press **MENU/OK** to set the clock.

TIME DIFFERENCE

Switch the camera clock instantly from your home time zone to the local time at your destination when traveling. To specify the difference between your local and home time zone:

- 1 Highlight **← LOCAL** and press **MENU/OK**.
- 2 Use the selector to choose the time difference between local time and your home time zone. Press **MENU/OK** when settings are complete.

To set the camera clock to local time, highlight **← LOCAL** and press **MENU/OK**. To set the clock to the time in your home time zone, select **HOME**. If **← LOCAL** is selected, **←** will be displayed in yellow for about three seconds when the camera is turned on.

Options	
← LOCAL	HOME

言語/LANG.

Choose a language.

MY MENU SETTING

Edit the items listed in the **MY** (MY MENU) tab, a personalized custom menu of frequently-used options.

- 1 Highlight **USER SETTING > MY MENU SETTING** in the **(SET UP)** tab and press **MENU/OK** to display the options at right.

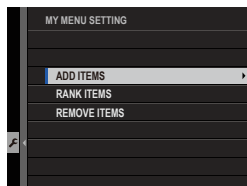

- 2 Press the selector up or down to highlight **ADD ITEMS** and press **MENU/OK**. Options that can be added to "my menu" are highlighted in blue.

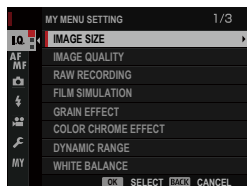

Items currently in "my menu" are indicated by check marks.

- 3 Highlight an item and press **MENU/OK** to add it to "my menu".

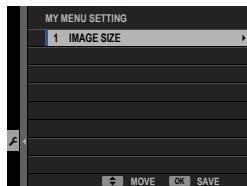

- 4 Press **MENU/OK** to return to the edit display.
- 5 Repeat Steps 3 and 4 until all the desired items have been added.

"My menu" can contain up to 16 items.

Editing "My Menu"

To reorder or delete items, select **RANK ITEMS** or **REMOVE ITEMS** in Step 1.

SENSOR CLEANING

Remove dust from the camera image sensor.

- **OK:** Clean the sensor immediately.
- **WHEN SWITCHED ON:** Sensor cleaning will be performed when the camera is turned on.
- **WHEN SWITCHED OFF:** Sensor cleaning will be performed when the camera turns off (sensor cleaning is not however performed if the camera turns off in playback mode).



Dust that cannot be removed using sensor cleaning can be removed manually.

BATTERY AGE

Check the age (expressed as a number between 0 and 4) of the batteries in the camera and the vertical power-booster grip.

RESET

Reset shooting or setup menu options to default values.

- 1 Highlight the desired option and press **MENU/OK**.

Option	Description
SHOOTING MENU RESET	Reset all shooting menu settings other than custom white balance and custom settings banks created using EDIT/SAVE CUSTOM SETTING to default values.
SET-UP RESET	Reset all setup menu settings other than DATE/TIME , TIME DIFFERENCE , and CONNECTION SETTING to default values.

- 2 A confirmation dialog will be displayed; highlight **OK** and press **MENU/OK**.

SOUND SETTING

Make changes to camera sounds.

To access sound settings, press **MENU/OK**, select the  (**SET UP**) tab, and choose **SOUND SET-UP**.

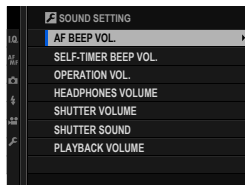

AF BEEP VOL.

Choose the volume of the beep that sounds when the camera focuses. The beep can be muted by selecting  **OFF**.

Options

 (high)

 (medium)

 (low)

 **OFF** (mute)

SELF-TIMER BEEP VOL.

Choose the volume of the beep that sounds while the self-timer is active. The beep can be muted by selecting  **OFF**.

Options

 (high)

 (medium)

 (low)

 **OFF** (mute)

OPERATION VOL.

Adjust the volume of the sounds produced when camera controls are operated. Choose  **OFF** to disable control sounds.

Options

 (high)

 (medium)

 (low)

 **OFF** (mute)

HEADPHONES VOLUME

Adjust headphone volume. Choose from values between 0 and 10.

SHUTTER VOLUME

Adjust the volume of the sounds produced by the electronic shutter. Choose OFF to disable the shutter sound.

Options

 (high) (medium) (low)OFF (mute)

SHUTTER SOUND

Choose the sound made by the electronic shutter.

Options

 1 2 3

PLAYBACK VOLUME

Adjust playback volume. Choose from values between 0 and 10.

SCREEN SETTING

Make changes to display settings.

To access display settings, press **MENU/OK**, select the  (**SET UP**) tab, and choose **SCREEN SET-UP**.

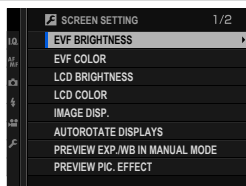

EVF BRIGHTNESS

Adjust the brightness of the display in the electronic viewfinder. Select **MANUAL** to choose from 11 options from +5 (bright) to -5 (dark), or select **AUTO** for automatic brightness adjustment.

Options	
MANUAL	AUTO

EVF COLOR

Adjust the hue of the display in the electronic viewfinder.

Options										
+5	+4	+3	+2	+1	0	-1	-2	-3	-4	-5

LCD BRIGHTNESS

Adjust monitor brightness.

Options										
+5	+4	+3	+2	+1	0	-1	-2	-3	-4	-5

LCD COLOR

Adjust monitor hue.

Options										
+5	+4	+3	+2	+1	0	-1	-2	-3	-4	-5

IMAGE DISP.

Choose how long images are displayed after shooting. Colors may differ slightly from those in the final image and “noise” mottling may be visible at high sensitivities.

Option	Description
CONTINUOUS	Pictures are displayed until the MENU/OK button is pressed or the shutter button is pressed halfway. To zoom in on the active focus point, press the center of the rear command dial; press again to cancel zoom.
1.5 SEC	Pictures are displayed for the selected time or until the shutter button is pressed halfway.
0.5 SEC	
OFF	Pictures are not displayed after shooting.

AUTOROTATE DISPLAYS

Choose whether the indicators in the viewfinder and LCD monitor rotate to match camera orientation.

Options	
ON	OFF

PREVIEW EXP./WB IN MANUAL MODE

Select **PREVIEW EXP./WB** to enable exposure and white balance preview in manual exposure mode, or choose **PREVIEW WB** to preview only white balance (**PREVIEW WB** is recommended in situations in which exposure and white balance are likely to change during shooting, as may be the case when you use a flash with an incandescent monitoring lamp). Select **OFF** when using a flash or on other occasions on which exposure may change when the picture is taken.

Options		
PREVIEW EXP./WB	PREVIEW WB	OFF

PREVIEW PIC. EFFECT

Choose **ON** to preview the effects of film simulation, white balance, and other settings in the monitor, **OFF** to make shadows in low-contrast, back-lit scenes and other hard-to-see subjects more visible.

Options	
ON	OFF

 If **OFF** is selected, the effects of camera settings will not be visible in the monitor and colors and tone will differ from those in the final picture. The display will however be adjusted to show the effects of advanced filters and of monochrome and sepia settings.

FRAMING GUIDELINE

Choose a framing grid for shooting mode.

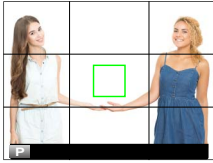
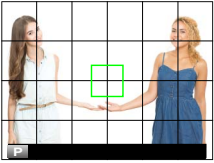
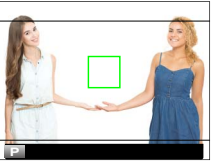
		Option		
		GRID 9	GRID 24	HD FRAMING
Display				
	<p>For “rule of thirds” composition.</p>	<p>A six-by-four grid.</p>	<p>Frame HD pictures in the crop shown by the lines at the top and bottom of the display. Framing guides can be changed as desired for tethered shooting.</p>	

 Framing guides are not shown at default settings but can be displayed using **SCREEN SET-UP > DISP. CUSTOM SETTING** (158).

Tethered shooting is available with Adobe® Photoshop® Lightroom® and HS-V5 tethered shooting software (available separately). Users of Adobe® Photoshop® Lightroom® who wish to customize the HD framing guide will require FUJIFILM Tether Shooting Plug-in PRO (available separately).

AUTOROTATE PB

Choose **ON** to automatically rotate “tall” (portrait-orientation) pictures during playback.

Options	
ON	OFF

FOCUS SCALE UNITS

Choose the units used for the focus distance indicator.

Options	
METERS	FEET

DISP. CUSTOM SETTING

Choose the items shown in the standard indicator display.

- 1 In shooting mode, press **DISP/BACK** until standard indicators are displayed.
- 2 Press **MENU/OK** and select **SCREEN SET-UP > DISP. CUSTOM SETTING** in the **(SET UP)** tab.
- 3 Highlight items and press **MENU/OK** to select or deselect.

Item	Default	Item	Default
FRAMING GUIDELINE	<input type="checkbox"/>	SHUTTER TYPE	<input checked="" type="checkbox"/>
ELECTRONIC LEVEL	<input type="checkbox"/>	FLASH	<input checked="" type="checkbox"/>
FOCUS FRAME	<input checked="" type="checkbox"/>	CONTINUOUS MODE	<input checked="" type="checkbox"/>
AF DISTANCE INDICATOR	<input type="checkbox"/>	DUAL IS MODE	<input checked="" type="checkbox"/>
MF DISTANCE INDICATOR	<input checked="" type="checkbox"/>	TOUCH SCREEN MODE	<input checked="" type="checkbox"/>
HISTOGRAM	<input type="checkbox"/>	WHITE BALANCE	<input checked="" type="checkbox"/>
LIVE VIEW HIGHLIGHT ALERT	<input type="checkbox"/>	FILM SIMULATION	<input checked="" type="checkbox"/>
SHOOTING MODE	<input checked="" type="checkbox"/>	DYNAMIC RANGE	<input checked="" type="checkbox"/>
APERTURE/S-SPEED/ISO	<input checked="" type="checkbox"/>	FRAMES REMAINING	<input checked="" type="checkbox"/>
INFORMATION BACKGROUND	<input checked="" type="checkbox"/>	IMAGE SIZE/QUALITY	<input checked="" type="checkbox"/>
Expo. Comp. (Digit)	<input type="checkbox"/>	MOVIE MODE & REC. TIME	<input checked="" type="checkbox"/>
Expo. Comp. (Scale)	<input checked="" type="checkbox"/>	MIC LEVEL	<input checked="" type="checkbox"/>
FOCUS MODE	<input checked="" type="checkbox"/>	BATTERY LEVEL	<input checked="" type="checkbox"/>
PHOTOMETRY	<input checked="" type="checkbox"/>	FRAMING OUTLINE	<input type="checkbox"/>

- 4 Press **DISP/BACK** to save changes.
- 5 Press **DISP/BACK** as needed to exit the menus and return to the shooting display.

SUB MONITOR SETTING

Choose the items shown in the secondary LCD monitor.

- 1 Press **MENU/OK** and select **SCREEN SET-UP > SUB MONITOR SETTING** in the **(SET UP)** tab.
- 2 Select **STILL MODE** or **MOVIE MODE**.

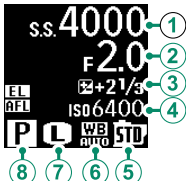
- 3 Highlight items for display in positions ① to ⑧ and press **MENU/OK** to select or de-select. Items not available when **MOVIE MODE** is selected are indicated by asterisks (*).
 

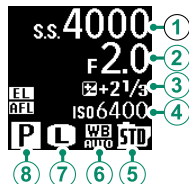

- **Text (items ① to ④):** SHUTTER SPEED, APERTURE, EXPO. COMP., ISO, MOVIE MODE, FRAMES REM. *, REC. TIME, NONE
 - **Icons (items ⑤ to ⑧):** FILM SIMULATION, WHITE BALANCE, IMAGE SIZE *, SHOOTING MODE, PHOTOMETRY, DRIVE MODE *, FOCUS MODE, IMAGE QUALITY *, BATTERY LEVEL, CARD SLOT OPTIONS, SHUTTER TYPE *, DYNAMIC RANGE *, MOVIE MODE *, NONE
- 4 Press **DISP/BACK** to save changes.

BUTTON/DIAL SETTING

Access options for camera controls.

To access control options, press **MENU/OK**, select the  (**SET UP**) tab, and choose **BUTTON/DIAL SETTING**.

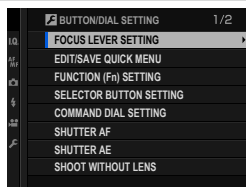



FOCUS LEVER SETTING

Choose the functions performed by the focus stick (focus lever).

Option	Description
LOCK (OFF)	The focus stick cannot be used during shooting.
PUSH  TO UNLOCK	Press the stick to view the focus-point display and tilt the stick to select a focus point.
ON	Tilt the stick to view the focus-point display and select a focus point.

EDIT/SAVE QUICK MENU

Choose the items displayed in the quick menu.

- 1 Select  **BUTTON/DIAL SETTING > EDIT/SAVE QUICK MENU** in the  (**SET UP**) tab.
- 2 The current quick menu will be displayed; use the selector to highlight the item you wish to change and press **MENU/OK**.
- 3 Highlight any of the following options and press **MENU/OK** to assign it to the selected position.
 - IMAGE SIZE
 - IMAGE QUALITY
 - FILM SIMULATION*
 - GRAIN EFFECT*
 - COLOR CHROME EFFECT
 - DYNAMIC RANGE*
 - WHITE BALANCE*
 - HIGHLIGHT TONE*
 - SHADOW TONE*
 - COLOR*
 - SHARPNESS*
 - NOISE REDUCTION*
 - SELECT CUSTOM SETTING*
 - AF MODE
 - FACE/EYE DETECTION SETTING
 - MF ASSIST
 - TOUCH SCREEN MODE
 - SELF-TIMER
 - PHOTOMETRY
 - SHUTTER TYPE
 - FLASH FUNCTION SETTING
 - FLASH COMPENSATION
 - MOVIE MODE
 - MIC LEVEL ADJUSTMENT
 - EVF/LCD BRIGHTNESS
 - EVF/LCD COLOR
 - NONE

* Stored in custom settings bank.



 Select **NONE** to assign no option to the selected position. When **SELECT CUSTOM SETTING** is selected, current settings are shown in the quick menu by the label **BASE**.

- 4 Highlight the desired item and press **MENU/OK** to assign it to the selected position.

 The quick menu can also be accessed in shooting mode by holding the **Q** button.

FUNCTION (Fn) SETTING

Choose the roles played by the function buttons.

- 1 Select  **BUTTON/DIAL SETTING** > **FUNCTION (Fn) SETTING** in the  **(SET UP)** tab.
- 2 Highlight the desired control and press **MENU/OK**.
- 3 Highlight any of the following options and press **MENU/OK** to assign it to the selected control.
 - EXPO. COMP.
 - IMAGE SIZE
 - IMAGE QUALITY
 - RAW
 - FILM SIMULATION
 - GRAIN EFFECT
 - COLOR CHROME EFFECT
 - DYNAMIC RANGE
 - WHITE BALANCE
 - SELECT CUSTOM SETTING
 - FOCUS AREA
 - FOCUS CHECK
 - AF MODE
 - RAPID AF
 - FACE/EYE DETECTION SETTING
 - SELF-TIMER
 - AE BKT SETTING
 - PHOTOMETRY
 - SHUTTER TYPE
 - ISO AUTO SETTING
 - WIRELESS COMMUNICATION
 - FLASH FUNCTION SETTING
 - TTL-LOCK
 - MODELING FLASH
 - MIC LEVEL ADJUSTMENT
 - PREVIEW DEPTH OF FIELD
 - PREVIEW EXP/WB IN MANUAL MODE
 - PREVIEW PIC. EFFECT
 - HISTOGRAM
 - ELECTRONIC LEVEL
 - AE LOCK ONLY
 - AF LOCK ONLY
 - AE/AF LOCK
 - AF-ON
 - LOCK SETTING
 - PLAYBACK
 - NONE (control disabled)



Function button assignment options can also be accessed by holding the **DISP/BACK** button. The selector cannot be assigned more than one role at a time.

AF-ON

If **AF-ON** is selected, you can press the control instead of keeping the shutter button pressed halfway.

MODELING FLASH

If **MODELING FLASH** is selected when a compatible shoe-mounted flash unit is attached, you can press the control to test-fire the flash and check for shadows and the like (modeling flash).

TTL-LOCK

If **TTL-LOCK** is selected, you can press the control to lock flash output according to the option selected for **FLASH SETTING > TTL-LOCK MODE** ( 114).

SELECTOR BUTTON SETTING

Choose the roles played by the up, down, left, and right buttons on the selector.

Option	Description
Fn BUTTON	The selector buttons serve as function buttons.
FOCUS AREA	The selector buttons can be used to position the focus area.

 Selecting **FOCUS AREA** prevents you accessing the functions assigned to the function buttons.

COMMAND DIAL SETTING

Choose the roles played by the command dials.

Option	Description
▲ F ▼ S.S.	The front command dial controls aperture, the rear command dial shutter speed.
▲ S.S. ▼ F	The front command dial controls shutter speed, the rear command dial aperture.

SHUTTER AF

Choose whether the camera focuses when the shutter button is pressed halfway.

Option	Description
ON	In focus mode S (AF-S) , the camera focuses when the shutter button is pressed halfway and locks focus while the button remains in this position. In focus mode C (AF-C) , focus is adjusted continually while the button is pressed halfway.
OFF	The camera does not focus when the shutter button is pressed halfway.

SHUTTER AE

If **ON** is selected, exposure will lock while the shutter button is pressed halfway.

Options	
ON	OFF

 Select **OFF** to allow the camera to adjust exposure before each shot taken in burst mode.

SHOOT WITHOUT LENS

Choose **ON** to enable the shutter release when no lens is attached.

Options	
ON	OFF

FOCUS RING

Choose the direction in which the focus ring is rotated to increase the focus distance.



Options	
 CW (clockwise)	 CCW (counterclockwise)

AE/AF-LOCK MODE

If **AE&AF ON WHEN PRESSING** is selected, exposure and/or focus will lock while you press the button to which exposure or focus lock is assigned. If **AE&AF ON/OFF SWITCH** is selected, exposure and/or focus will lock when the button is pressed and remain locked until it is pressed again.

Options	
AE&AF ON WHEN PRESSING	AE&AF ON/OFF SWITCH

EXPO. COMP. BUTTON SETTING

Control the behavior of the rear command dial and the button to which exposure compensation is assigned. If  **ON WHEN PRESSING** is selected, exposure compensation can be adjusted by holding the button while rotating dial; if  **ON/OFF SWITCH** is selected, exposure compensation can be set by pressing the button once, rotating the dial, and then pressing the button again.

Options	
ON WHEN PRESSING	ON/OFF SWITCH

TOUCH SCREEN SETTING



Enable or disable touch-screen controls.

Options	
ON	OFF

LOCK

Lock selected controls to prevent unintended operation.

Options	Description
LOCK SETTING	Choose from the following: <ul style="list-style-type: none"> • UNLOCK: Reset lock options. • ALL FUNCTION: Lock all controls in the FUNCTION SELECTION list. • SELECTED FUNCTION: Lock only the controls selected in the FUNCTION SELECTION list.
FUNCTION SELECTION	Choose the controls locked when SELECTED FUNCTION is chosen for LOCK SETTING .

 The selector and the **Q** button can be locked at any time by pressing and holding the **MENU/OK** button ( 5).

POWER MANAGEMENT

Adjust power management settings.

To access power management settings, press **MENU/OK**, select the  (**SET UP**) tab, and choose **POWER MANAGEMENT**.

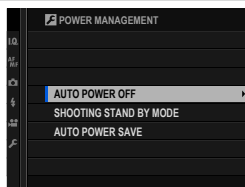

AUTO POWER OFF

Choose the length of time before the camera turns off automatically when no operations are performed. Shorter times increase battery life; if **OFF** is selected, the camera must be turned off manually.

Options					
5 MIN	2 MIN	1 MIN	30 SEC	15 SEC	OFF

SHOOTING STAND BY MODE

In standby mode, all displays except the secondary LCD monitor turn off to save power. Choose how long the camera waits before entering standby mode when no operations are performed, or select **OFF** to disable standby mode.

Options					
5 MIN	2 MIN	1 MIN	30 SEC	15 SEC	OFF

AUTO POWER SAVE

If **ON** is selected, the display frame rate will drop to save power if no operations are performed for a short period, but the normal frame rate can be restored by operating camera controls.

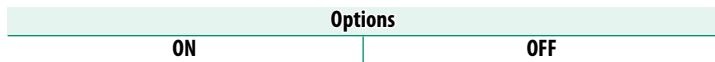

SAVE DATA SETTING

Make changes to file management settings.

To access file management settings, press **MENU/OK**, select the **⏏ (SET UP)** tab, and choose **SAVE DATA SET-UP**.

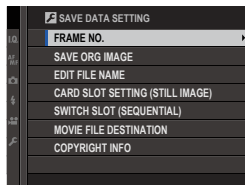

FRAME NO.

New pictures are stored in image files named using a four-digit file number assigned by adding one to the last file number used. The file number is displayed during playback as shown. **FRAME NO.** controls whether file numbering is reset to 0001 when a new memory card is inserted or the current memory card is formatted.

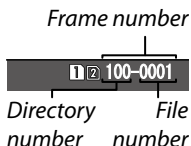

Option	Description
CONTINUOUS	Numbering continues from the last file number used or the first available file number, whichever is higher. Choose this option to reduce the number of pictures with duplicate file names.
RENEW	Numbering is reset to 0001 after formatting or when a new memory card is inserted.

 If the frame number reaches 999-9999, the shutter release will be disabled. Format the memory card after transferring to a computer any pictures you wish to keep.

Selecting **⏏ USER SETTING > RESET** sets **FRAME NO.** to **CONTINUOUS** but does not reset the file number.

Frame numbers for pictures taken with other cameras may differ.

SAVE ORG IMAGE

Choose **ON** to save unprocessed copies of pictures taken using **RED EYE REMOVAL**.

Options	
ON	OFF

EDIT FILE NAME

Change the file name prefix. sRGB images use a four-letter prefix (default "DSCF"), Adobe RGB images a three-letter prefix ("DSF") preceded by an underscore.

Option	Default prefix	Sample file name
sRGB	DSCF	ABCD0001
AdobeRGB	_DSF	_ABC0001

 File name prefixes can be edited using touch controls.

CARD SLOT SETTING (STILL IMAGE)

Choose the role played by the card in the second slot.

Option	Description
SEQUENTIAL	The card in the second slot is used only when the card in the first slot is full.
BACKUP	Each picture is recorded twice, once to each card.
RAW / JPEG	As for SEQUENTIAL , except that the RAW copy of pictures taken with FINE+RAW or NORMAL+RAW selected for  IMAGE QUALITY SETTING > IMAGE QUALITY will be saved to the card in the first slot and the JPEG copy to the card in the second slot.

SWITCH SLOT (SEQUENTIAL)

Choose the card that is recorded to first when **SEQUENTIAL** is selected for **CARD SLOT SETTING (STILL IMAGE)**.

Options	
SLOT 1	SLOT 2

MOVIE FILE DESTINATION

Choose the slot used to store movies.

Options	
SLOT 1	SLOT 2

COPYRIGHT INFO

Copyright information, in the form of Exif tags, can be added to new images as they are taken. Changes to copyright information are reflected only in images taken after the changes are made.

Option	Description
DISP COPYRIGHT INFO	View the current copyright information.
ENTER AUTHOR'S INFO	Enter the creator's name.
ENTER COPYRIGHT INFO	Enter the name of the copyright holder.
DELETE COPYRIGHT INFO	Delete the current copyright information. This change applies only to images taken after this option is selected; copyright information recorded with existing images is not affected.



Copyright information can be edited using touch controls.

CONNECTION SETTING

Adjust settings for connection to other devices.

To access connection settings, press **MENU/OK**, select the  (**SET UP**) tab, and choose **CONNECTION SETTING**.

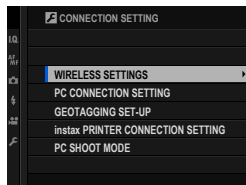

WIRELESS SETTINGS

Adjust settings for connection to wireless networks.

Option	Description
GENERAL SETTINGS	Choose a name (NAME) to identify the camera on the wireless network (the camera is assigned a unique name by default) or select RESET WIRELESS SETTINGS to restore default settings.
RESIZE IMAGE FOR SMARTPHONE 	Choose ON (the default setting, recommended in most circumstances) to resize larger images to 3M for upload to smartphones, OFF to upload images at their original size. Resizing applies only to the copy uploaded to the smartphone; the original is not affected.

PC CONNECTION SETTING

Choose the method used for connection to computers. Choose **SIMPLE SETUP** to connect using WPS, **MANUAL SETUP** to configure network settings manually.

Options	
SIMPLE SETUP	MANUAL SETUP

 For more information on wireless connections, visit:
<http://fujifilm-dsc.com/wifi/>

GEOTAGGING SET-UP

View location data downloaded from a smartphone and choose whether to save the data with your pictures.

Option	Description
GEOTAGGING	Choose whether location data downloaded from a smartphone are embedded in pictures as they are taken.
LOCATION INFO	Display the location data last downloaded from a smartphone.

 For more information on wireless connections, visit:
<http://fujifilm-dsc.com/wifi/>

instax PRINTER CONNECTION SETTING

Adjust settings for connection to optional FUJIFILM instax SHARE printers.

The Printer Name (SSID) and Password

The printer name (SSID) can be found on the bottom of the printer; the default password is "1111". If you have already chosen a different password to print from a smartphone, enter that password instead.

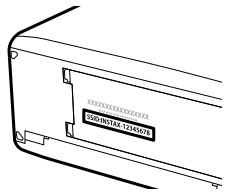

PC SHOOT MODE

Adjust settings for remote photography (tethered shooting).

Option	Description
OFF	Choose this option if you do not intend to use tethered shooting.
USB AUTO	Tethered shooting mode is selected automatically when the camera is connected to a computer via USB. When no computer is connected, the results are the same as OFF .
USB FIXED	The camera functions in tethered shooting mode even when not connected to a computer. At default settings, pictures are not saved to the memory card, but pictures taken while the camera is not connected will be transferred to the computer when it is connected.

 **POWER MANAGEMENT > AUTO POWER OFF** also apply during tethered shooting. Select **OFF** to prevent the camera turning off automatically.

 Tethered shooting is available with software such as HS-V5 (available separately) or FUJIFILM X Acquire (available for free download from the FUJIFILM website) or when the FUJIFILM Tether Shooting Plug-in PRO or Tether Shooting Plug-in (both available separately) is used with Adobe® Photoshop® Lightroom®.

Shortcuts

9

Shortcut Options

Customize camera controls to suit your style or situation.

Frequently-used options can be added to the **Q** menu or a custom “my” menu or assigned to an **Fn** (function) button for direct access:

- **The Q menu** (📖 177): The **Q** menu is displayed by pressing the **Q** button. Use the **Q** menu to view or change the options selected for frequently-used menu items.
- **“My menu”** (📖 184): Add frequently-used options to this custom menu, which can be viewed by pressing **MENU/OK** and selecting the **MY** (“MY MENU”) tab.
- **The function buttons** (📖 180): Use the function buttons for direct access to selected features.

The Q (Quick Menu) Button

Press **Q** for quick access to selected options.

The Quick Menu Display

At default settings, the quick menu contains the following items:

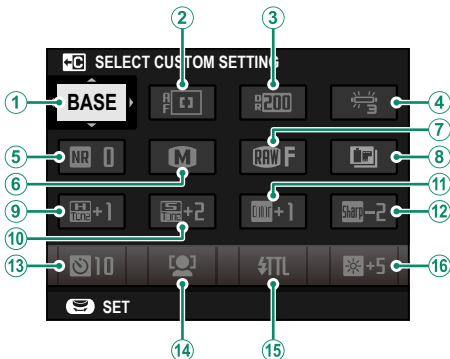

- | | |
|-------------------------|------------------------------|
| ① SELECT CUSTOM SETTING | ⑨ HIGHLIGHT TONE |
| ② AF MODE | ⑩ SHADOW TONE |
| ③ DYNAMIC RANGE | ⑪ COLOR |
| ④ WHITE BALANCE | ⑫ SHARPNESS |
| ⑤ NOISE REDUCTION | ⑬ SELF-TIMER |
| ⑥ IMAGE SIZE | ⑭ FACE/EYE DETECTION SETTING |
| ⑦ IMAGE QUALITY | ⑮ FLASH FUNCTION SETTING |
| ⑧ FILM SIMULATION | ⑯ EVF/LCD BRIGHTNESS |

The quick menu shows the options currently selected for items ②–⑯, which can be changed as described on page 179.

SELECT CUSTOM SETTING

The **Q** **IMAGE QUALITY SETTING > SELECT CUSTOM SETTING** item (item ①) shows the current custom settings bank:

- **BASE**: No custom settings bank selected.
- **C 1–C7**: Select a bank to view the settings saved using the **Q** **IMAGE QUALITY SETTING > EDIT/SAVE CUSTOM SETTING** option.
- **BASE** **C 1–C7**: The current custom settings bank.

Viewing and Changing Settings

- 1 Press **Q** to display the quick menu during shooting.

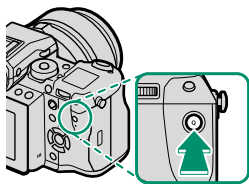

- 2 Use the selector to highlight items and rotate the rear command dial to change.

 Changes are not saved to the current settings bank. Settings that differ from those in the current settings bank (**C1–C7**) are shown in red.

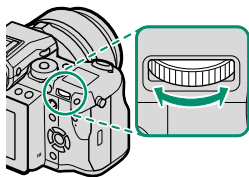

- 3 Press **Q** to exit when settings are complete.

 The quick menu can also be edited using touch controls.

Editing the Quick Menu

To choose the items displayed in the quick menu:

- 1 Press and hold the **Q** button during shooting.

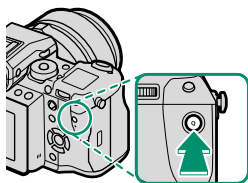

- 2 The current quick menu will be displayed; use the selector to highlight the item you wish to change and press **MENU/OK**.
- 3 Highlight any of the following options and press **MENU/OK** to assign it to the selected position.

- IMAGE SIZE
- IMAGE QUALITY
- FILM SIMULATION*
- GRAIN EFFECT*
- COLOR CHROME EFFECT
- DYNAMIC RANGE*
- WHITE BALANCE*
- HIGHLIGHT TONE*
- SHADOW TONE*
- COLOR*
- SHARPNESS*
- NOISE REDUCTION*
- SELECT CUSTOM SETTING*
- AF MODE
- FACE/EYE DETECTION SETTING
- MF ASSIST
- TOUCH SCREEN MODE
- SELF-TIMER
- PHOTOMETRY
- SHUTTER TYPE
- FLASH FUNCTION SETTING
- FLASH COMPENSATION
- MOVIE MODE
- MIC LEVEL ADJUSTMENT
- EVF/LCD BRIGHTNESS
- EVF/LCD COLOR
- NONE

* Stored in custom settings bank.

 Select **NONE** to assign no option to the selected position. When **SELECT CUSTOM SETTING** is selected, current settings are shown in the quick menu by the label **BASE**.

 The quick menu can also be edited using **FUNCTION/DIAL SETTING > EDIT/SAVE QUICK MENU**.

The Fn (Function) Buttons

Assign roles to the function buttons and the center of the rear command dial for quick access to selected features.

The default assignments are:

Fn1 button

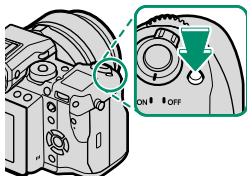

Exposure compensation

Fn2 button

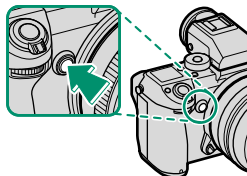

Exposure bracketing

Fn3 button

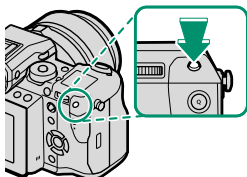

Histogram

Fn4 button

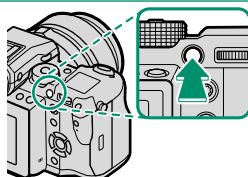

Focus lock

Fn5 button

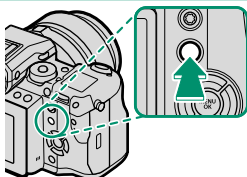

Exposure lock

Fn6 button

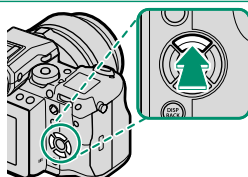

AF mode

Fn7 button

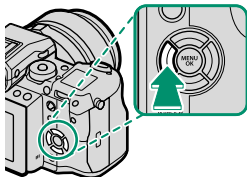

Film simulation

Fn8 button

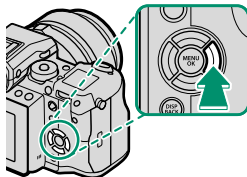

White balance

Fn9 button

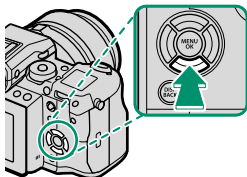

Rapid AF

Center of rear command dial

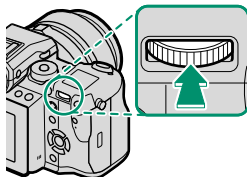

Focus check

Assigning Roles to the Function Buttons

To assign roles to the buttons:

- 1 Press and hold the **DISP/BACK** button until a button selection menu is displayed.

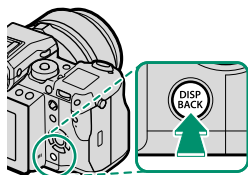

- 2 Highlight a button and press **MENU/OK**.
- 3 Highlight the desired role and press **MENU/OK** to assign it to the selected button. Choose from:

- EXPO. COMP.
- IMAGE SIZE
- IMAGE QUALITY
- RAW
- FILM SIMULATION
- GRAIN EFFECT
- COLOR CHROME EFFECT
- DYNAMIC RANGE
- WHITE BALANCE
- SELECT CUSTOM SETTING
- FOCUS AREA
- FOCUS CHECK
- AF MODE
- RAPID AF
- FACE/EYE DETECTION SETTING
- SELF-TIMER
- AE BKT SETTING
- PHOTOMETRY
- SHUTTER TYPE
- ISO AUTO SETTING
- WIRELESS COMMUNICATION
- FLASH FUNCTION SETTING
- TTL-LOCK
- MODELING FLASH
- MIC LEVEL ADJUSTMENT
- PREVIEW DEPTH OF FIELD
- PREVIEW EXP./WB IN MANUAL MODE
- PREVIEW PIC. EFFECT
- HISTOGRAM
- ELECTRONIC LEVEL
- AE LOCK ONLY
- AF LOCK ONLY
- AE/AF LOCK
- AF-ON
- LOCK SETTING
- PLAYBACK
- NONE (control disabled)

 Button assignments can also be selected using **□ BUTTON/DIAL SETTING > FUNCTION (Fn) SETTING**. The selector cannot be assigned more than one role at a time.

AF-ON

If **AF-ON** is selected, you can press the control instead of keeping the shutter button pressed halfway.

MODELING FLASH

If **MODELING FLASH** is selected when a compatible shoe-mounted flash unit is attached, you can press the control to test-fire the flash and check for shadows and the like (modeling flash).

TTL-LOCK

If **TTL-LOCK** is selected, you can press the control to lock flash output according to the option selected for **FLASH SETTING > TTL-LOCK MODE** ( 114).



MY MENU

Access a personalized menu of frequently-used options.

To display “my menu”, press **MENU/OK** in the shooting display and select the **MY** (**MY MENU**) tab.

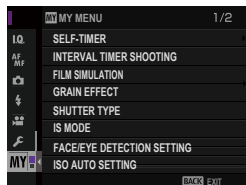

The **MY** tab is only available if options have been assigned to **MY MENU**.

MY MENU SETTING

To choose the items listed in the **MY** (MY MENU) tab:

- 1 Highlight **USER SETTING > MY MENU SETTING** in the **(SET UP)** tab and press **MENU/OK** to display the options at right.

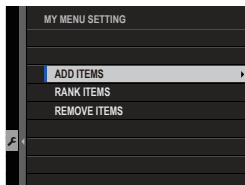

- 2 Press the selector up or down to highlight **ADD ITEMS** and press **MENU/OK**. Options that can be added to "my menu" are highlighted in blue.

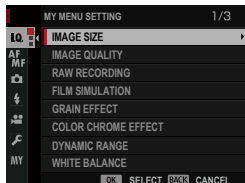

 Items currently in "my menu" are indicated by check marks.

- 3 Highlight an item and press **MENU/OK** to add it to "my menu".

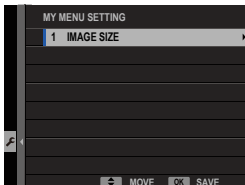

- 4 Press **MENU/OK** to return to the edit display.
- 5 Repeat Steps 3 and 4 until all the desired items have been added.

 "My menu" can contain up to 16 items.

Editing "My Menu"

To reorder or delete items, select **RANK ITEMS** or **REMOVE ITEMS** in Step 1.

10 Peripherals and Optional Accessories

Lenses

The camera can be used with lenses for the FUJIFILM G-mount.

Lens Parts

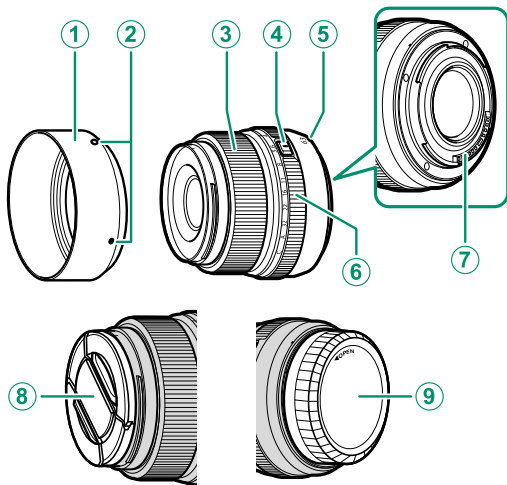

① Lens hood

② Mounting marks

③ Focus ring

④ Aperture ring lock release

⑤ Mounting marks (focal length)

⑥ Aperture ring

⑦ Lens signal contacts

⑧ Front lens cap

⑨ Rear lens cap



A GF63mmF2.8 R WR lens is used here for illustrative purposes.

Lens Care

Use a blower to remove dust, then gently wipe with a soft, dry cloth. Any remaining stains can be removed by wiping gently with a piece of FUJIFILM lens-cleaning paper to which a small amount of lens-cleaning fluid has been applied. Replace the front and rear caps when the lens is not in use.

Removing Lens Caps

Remove lens caps as shown.

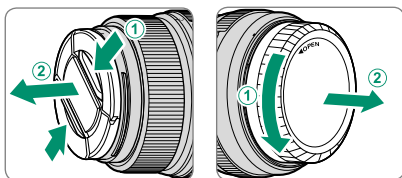

 Lens caps may differ from those shown.

Attaching Lens Hoods

When attached, lens hoods reduce glare and protect the front lens element.

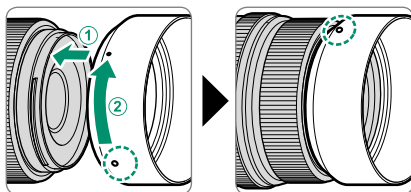

Vertical Battery Grips

The optional VG-GF1 vertical battery grip accommodates an extra battery for improved endurance and makes it easier to hold the camera rotated 90° to frame pictures in “tall” (portrait) orientation.

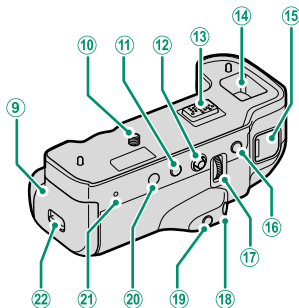
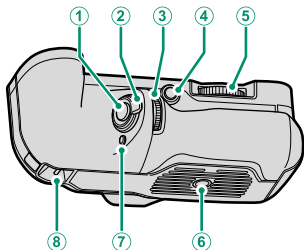

- ① Shutter button
- ② Control lock
- ③ Front command dial
- ④ **Fn2** (function 2) button
- ⑤ Lock screw knob
- ⑥ Tripod socket
- ⑦ **Fn1** (function 1) button
- ⑧ Eyelet for camera strap
- ⑨ Battery-chamber cover
- ⑩ Lock screw
- ⑪ **Fn5** (function 5) button
- ⑫ Focus stick (focus lever)

- ⑬ Connector
- ⑭ Compartment for connector cover supplied with camera
- ⑮ 15 V DC-IN connector
- ⑯ **Fn4** (function 4) button
- ⑰ Rear command dial
- ⑱ **Fn3** (function 3) button
- ⑲ **Q** (quick menu) button
- ⑳ **MENU/OK** button
- ㉑ Indicator lamps
- ㉒ Battery-chamber cover latch

 Do not attempt to attach the clips supplied with the camera to the eyelets (⑧) on the battery grip.

 All controls perform the same function as the matching controls on the camera.

Attaching the VB-GF1

The VB-GF1 attaches as shown below.

- 1 Remove the vertical battery grip connector cover from the camera and place it in the grip connector cover compartment.

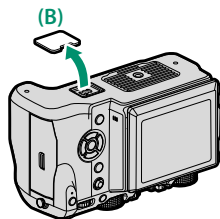

- 2 Align the connectors on the grip with the matching connectors on the camera. Rotate the lock screw knob to tighten the lock screw.

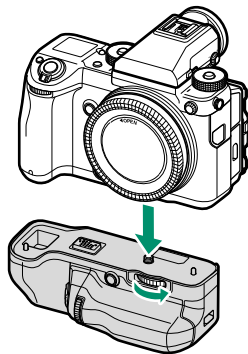
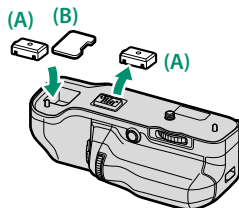

Inserting a Battery

Insert a battery as shown below.

- 1 Unlatch and open the battery-chamber cover.

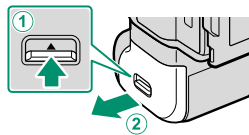

- 2 Slide the battery in until it latches.

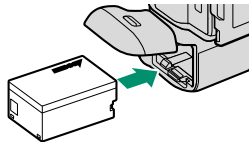

- 3 Close the battery-chamber cover.

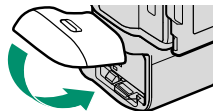



! The battery in the grip is used before the battery in the camera. The camera automatically switches to the camera battery when the battery in the grip is exhausted. Movie recording and bulb photography will end when the camera switches batteries. When the battery in the grip is exhausted, remove and charge the battery or insert a fully-charged spare battery. If the camera battery has enough charge to power the camera, the battery in the grip can be replaced without turning the camera off.

Using an AC Adapter

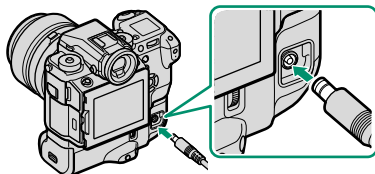
An optional AC-15V AC adapter can be used to power the camera when the battery grip is attached. The battery inserted in the grip will charge while the adapter is connected; charging takes about 120 minutes. Turn the camera off before disconnecting the AC adapter.



Battery charge status is shown by battery status icons when the camera is on (playback mode) and by the indicator lamp when the camera is off.

Battery status icon (camera on)	Indicator lamp (camera off)	Battery status
 (yellow)	On	Battery charging
 (green)	Off	Charging complete
 (red)	Blinks	Battery fault

Viewfinder Tilt Adapters

The optional EVF-TL1 tilt adapter lets you swivel the viewfinder left or right $\pm 45^\circ$ or up or down between 0° and 90° .

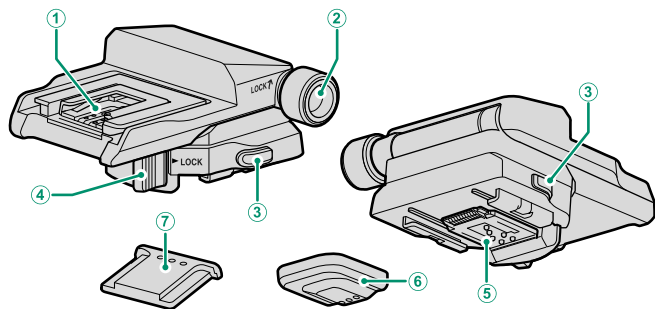

- ① Hot shoe
- ② Tilt lock knob
- ③ Adapter lock release
- ④ Horizontal swivel lock
- ⑤ Connectors
- ⑥ Connector cover
- ⑦ Hot shoe cover

Attaching the EVF-TL1

Slide the EVF-TL1 onto the camera hot shoe and then attach the EVF-GFX1 electronic viewfinder.

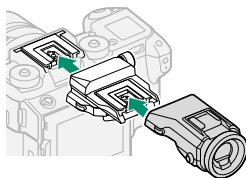

- Remove the hot shoe covers from the camera and EVF-TL1 before attaching the adapter and viewfinder.

Removing the EVF-TL1

Remove the viewfinder and then, keeping the lock releases (①) pressed, press down on the front of the adapter (②) and slide it from the camera as shown.

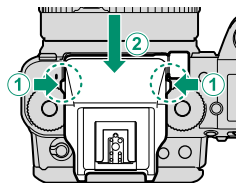

- Use only one tilt adapter at a time.

Using the EVF-TL1

Swivel the viewfinder into the desired position.

Swiveling the Viewfinder Up or Down

Loosen the tilt lock knob and swivel the viewfinder up or down from 0° to 90°.

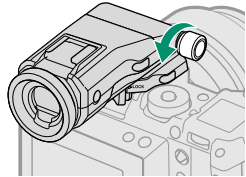

With the viewfinder in the desired position (①), tighten the tilt lock knob (②) to lock the viewfinder in place.

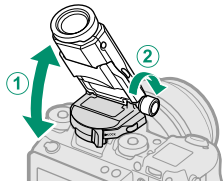

Swiveling the Viewfinder Left or Right

Release the horizontal swivel lock as shown and swivel the viewfinder left or right $\pm 45^\circ$.

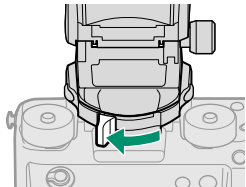

With the viewfinder in the desired position (①), return the horizontal swivel lock to the latched position (②) to lock the viewfinder in place.

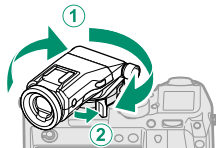



External Flash Units

Flash units can be mounted on the hot shoe or connected via the sync terminal.

External flash units are more powerful than their built-in counterparts. Some support high-speed sync (FP) and can be used at shutter speeds faster than the flash sync speed, while others can function as master flash units controlling remote units via optical wireless flash control.

 You may be unable to test-fire the flash in some circumstances, for example when a setup menu is displayed on the camera.

Red-Eye Removal

Red-eye removal is available when an option other than **OFF** is selected for  **FLASH SETTING > RED EYE REMOVAL** and  **AF/MF SETTING > FACE/EYE DETECTION SETTING** is **ON**. Red-eye removal minimizes “red-eye” caused when light from the flash is reflected from the subject’s retinas.

Flash Settings

To adjust settings for a flash unit mounted on the hot shoe or connected via the sync terminal:

- 1 Connect the unit to the camera.
- 2 In shooting mode, select **FLASH FUNCTION SETTING** in the **⚡ (FLASH SETTING)** menu tab. The options available vary with the flash unit.

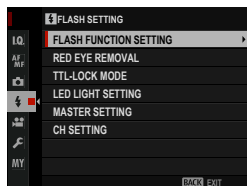

Menu	Description	
SYNC TERMINAL	Displayed when no compatible flash unit is connected or if a unit is connected via the sync terminal or uses only the X-contact on the hot shoe.	199
SHOE MOUNT FLASH	Displayed when an optional flash unit is mounted on the hot shoe and turned on.	200
MASTER (OPTICAL)	Displayed if an optional flash unit functioning as a master flash for FUJIFILM optical wireless remote flash control is connected and turned on.	203

 **SYNC TERMINAL** will be also displayed if an incompatible flash unit or no flash unit is connected.

- 3 Highlight items using the selector and rotate the rear command dial to change the highlighted setting.



- 4 Press **DISP/BACK** to put the changes into effect.

SYNC TERMINAL

The following options are available when no compatible flash unit is connected or if a unit is connected via the sync terminal or uses only the X-contact on the hot shoe.

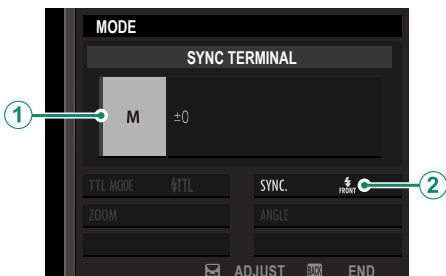

Setting	Description
① Flash control mode	<p>Choose from the following options:</p> <ul style="list-style-type: none"> • M: A trigger signal is transmitted from the sync terminal and hot shoe when a picture is taken. Choose a shutter speed slower than the sync speed; even slower speeds may be required if the unit uses long flashes or has a slow response time. • OFF (OFF): The sync terminal and hot shoe do not transmit a trigger signal.
② Sync	<p>Choose whether the flash is timed to fire immediately after the shutter opens (FRONT/1ST CURTAIN) or immediately before it closes (REAR/2ND CURTAIN). 1ST CURTAIN is recommended in most circumstances.</p>

The Sync Terminal

Use the sync terminal to connect flash units that require a sync cable.

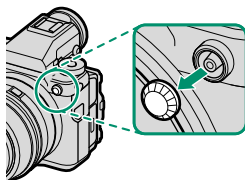





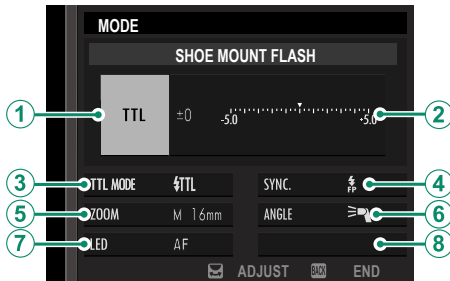

SHOE MOUNT FLASH

The following options are available when an optional shoe-mounted flash unit is attached and turned on.



Setting	Description
① Flash control mode	<p>The flash control mode selected with the flash unit. This can in some cases be adjusted from the camera; the options available vary with the flash.</p> <ul style="list-style-type: none"> • TTL: TTL mode. Adjust flash compensation (②). • M: The flash fires at the selected output regardless of subject brightness or camera settings. Output in some cases can be adjusted from the camera (②). • MULTI: Repeating flash. Compatible shoe-mounted flash units will fire multiple times with each shot. • OFF (OFF): The flash does not fire. Some flash units can be turned off from the camera.

Setting	Description
② Flash compensation/output	<p>The options available vary with flash control mode.</p> <ul style="list-style-type: none"> • TTL: Adjust flash compensation (the full value may not be applied if the limits of the flash control system are exceeded). In the cases of the EF-X20, EF-20, and EF-42, the selected value is added to the value selected with the flash unit. • M/MULTI: Adjust flash output (compatible units only). Choose from values expressed as fractions of full power, from 1/4 (mode M) or 1/4 (MULTI) down to 1/512 in increments equivalent to 1/3 EV. The desired results may not be achieved at low values if they exceed the limits of the flash control system; take a test shot and check the results.
③ Flash mode (TTL)	<p>Choose a flash mode for TTL flash control. The options available vary with the shooting mode (P, S, A, or M) selected.</p> <ul style="list-style-type: none"> • FLASH AUTO: The flash fires only as required; flash level is adjusted according to subject brightness. A  icon displayed when the shutter button is pressed halfway indicates that the flash will fire when the photo is taken. • STANDARD: The flash fires with every shot if possible; flash level is adjusted according to subject brightness. The flash will not fire if not fully charged when the shutter is released. • SLOW SYNC.: Combine the flash with slow shutter speeds when photographing portrait subjects against a backdrop of night scenery. The flash will not fire if not fully charged when the shutter is released.
④ Sync	<p>Control flash timing.</p> <ul style="list-style-type: none"> • FRONT (1ST CURTAIN): The flash fires immediately after the shutter opens (generally the best choice). • REAR (2ND CURTAIN): The flash fires immediately before the shutter closes. • (AUTO FP(HSS)): High-speed sync (compatible units only). The camera automatically engages front-curtain high-speed sync at shutter speeds faster than the flash sync speed. Equivalent to 1ST CURTAIN when MULTI is selected for flash control mode.

Setting	Description
⑤ Zoom	The angle of illumination (flash coverage) for units that support flash zoom. Some units allow the adjustment to be made from the camera. If AUTO is selected, zoom will automatically be adjusted to match coverage to lens focal length.
⑥ Lighting	If the unit supports this feature, choose from: <ul style="list-style-type: none"> •  (FLASH POWER PRIORITY): Gain range by slightly reducing coverage. •  (STANDARD): Match coverage to picture angle. •  (EVEN COVERAGE PRIORITY): Slightly increase coverage for more even lighting.
⑦ LED light	Choose how the built-in LED light functions during still photography (compatible units only): as a catchlight ( / CATCHLIGHT), as an AF-assist illuminator (AF/AF ASSIST), or as both a catchlight and an AF-ASSIST illuminator ( / AF ASSIST+CATCHLIGHT). Choose OFF to disable the LED during photography.
⑦ Number of flashes*	Choose the number of times the flash fires each time the shutter is released in MULTI mode.
⑧ Frequency*	Choose the frequency at which the flash fires in MULTI mode.

* Full value may not be applied if limits of flash control system are exceeded.

MASTER(OPTICAL)



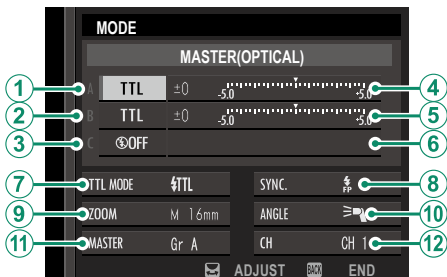

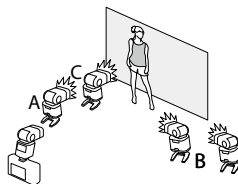

The options will be displayed if the unit is currently functioning as master flash for FUJIFILM optical wireless remote flash control.





The master and remote units can be placed in up to three groups (A, B, and C) and flash mode and flash level adjusted separately for each group. Four channels are available for communication between the units; separate channels can be used for different flash systems or to prevent interference when multiple systems are operating in close proximity.



Setting	Description
① Flash control mode (group A)	<p>Choose flash control modes for groups A, B, and C. TTL% is available for groups A and B only.</p> <ul style="list-style-type: none"> • TTL: The units in the group fire in TTL mode. Flash compensation can be adjusted separately for each group. • TTL%: If TTL% is selected for either group A or B, you can specify the output of the selected group as a percentage of the other and adjust overall flash compensation for both groups.
② Flash control mode (group B)	<ul style="list-style-type: none"> • M: In mode M, the units in the group fire at the selected output (expressed as a fraction of full power) regardless of subject brightness or camera settings.
③ Flash control mode (group C)	<ul style="list-style-type: none"> • MULTI: Choosing MULTI for any group sets all the units in all groups to repeating flash mode. All units will fire multiple times with each shot. • OFF (OFF): If OFF is selected, the units in the group will not fire.
④ Flash compensation/output (group A)	<p>Adjust flash level for the selected group according to option selected for flash control mode. Note that the full value may not be applied if the limits of the flash control system are exceeded.</p>
⑤ Flash compensation/output (group B)	<ul style="list-style-type: none"> • TTL: Adjust flash compensation. • M/MULTI: Adjust flash output.
⑥ Flash compensation/output (group C)	<ul style="list-style-type: none"> • TTL%: Choose the balance between groups A and B and adjust overall flash compensation.

Setting	Description
<p>⑦ Flash mode (TTL)</p>	<p>Choose a flash mode for TTL flash control. The options available vary with the shooting mode (P, S, A, or M) selected.</p> <ul style="list-style-type: none"> •  (FLASH AUTO): The flash fires only as required; flash level is adjusted according to subject brightness. A  icon displayed when the shutter button is pressed halfway indicates that the flash will fire when the photo is taken. •  (STANDARD): The flash fires with every shot if possible; flash level is adjusted according to subject brightness. The flash will not fire if not fully charged when the shutter is released. •  (SLOW SYNC.): Combine the flash with slow shutter speeds when photographing portrait subjects against a backdrop of night scenery. The flash will not fire if not fully charged when the shutter is released.
<p>⑧ Sync</p>	<p>Control flash timing.</p> <ul style="list-style-type: none"> •  (1ST CURTAIN): The flash fires immediately after the shutter opens (generally the best choice). •  (2ND CURTAIN): The flash fires immediately before the shutter closes. •  (AUTO FP(HSS)): High-speed sync (compatible units only). The camera automatically engages front-curtain high-speed sync at shutter speeds faster than the flash sync speed. Equivalent to 1ST CURTAIN when MULTI is selected for flash control mode.
<p>⑨ Zoom</p>	<p>The angle of illumination (flash coverage) for units that support flash zoom. Some units allow the adjustment to be made from the camera. If AUTO is selected, zoom will automatically be adjusted to match coverage to lens focal length.</p>

Setting	Description
⑩ Lighting	<p>If the unit supports this feature, choose from:</p> <ul style="list-style-type: none"> •  (FLASH POWER PRIORITY): Gain range by slightly reducing coverage. •  (STANDARD): Match coverage to picture angle. •  (EVEN COVERAGE PRIORITY): Slightly increase coverage for more even lighting.
⑪ Master	<p>Assign the master flash to group A (Gr A), B (Gr B), or C (Gr C). If OFF is selected, output from the master flash will be held to a level that does not affect the final picture. Available only if the unit is mounted on the camera hot shoe as a master flash for FUJIFILM optical wireless remote flash control in TTL, TTL%, or M mode.</p>
⑪ Number of flashes	<p>Choose the number of times the flash fires each time the shutter is released in MULTI mode.</p>
⑫ Channel	<p>Choose the channel used by the master flash for communication with the remote flash units. Separate channels can be used for different flash systems or to prevent interference when multiple systems are operating in close proximity.</p>
⑫ Frequency	<p>Choose the frequency at which the flash fires in MULTI mode.</p>

11 Connections

HDMI Output

Camera shooting and playback displays can be output to HDMI devices.

Connecting to HDMI Devices

Connect the camera to TVs or other HDMI devices using a third-party HDMI cable.

- 1 Turn the camera off.
- 2 Connect the cable as shown below, making sure the connectors are fully inserted.

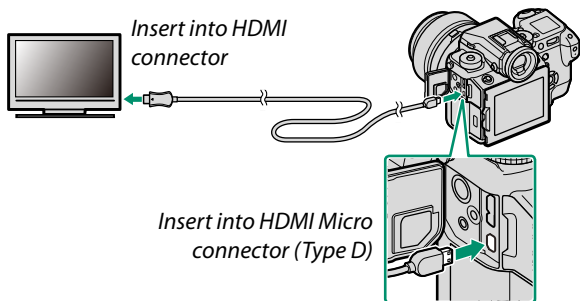

! Use an HDMI cable no more than 1.5 m (4.9 ft.) long.

- 3 Configure the device for HDMI input as described in the documentation supplied with the device.
- 4 Turn the camera on. You can now shoot and play back pictures while viewing the television display and save pictures to the HDMI device.

! The USB cable cannot be used while an HDMI cable is connected.

Shooting

Shoot photos and record movies while viewing the scene through the camera lens on or saving footage to the HDMI device.

Playback

To start playback, press the camera  button. The camera monitor turns off and pictures and movies are output to the HDMI device. Note that the camera volume controls have no effect on sounds played on the TV; use the television volume controls to adjust the volume.

 Some televisions may briefly display a black screen when movie playback begins.

Wireless Transfer

Establish a wireless LAN connection between your camera and smartphone.

For downloads and other information, visit:

<http://fujifilm-dsc.com/wifi/>

Wireless Connections: Smartphones

Install the “FUJIFILM Camera Remote” app on your smartphone to browse the images on the camera, download selected images, control the camera remotely, or copy location data to the camera. Once the app is installed, connect using the **SHOOTING SETTING > WIRELESS COMMUNICATION** or **PLAY BACK MENU > WIRELESS COMMUNICATION** options in the camera menus.



Connecting to Computers via USB

Connect the camera to a computer to download pictures or take pictures remotely.

Tethered Shooting

Take pictures remotely.

Mac OS X/macOS

Tethered shooting is available to purchasers of Adobe® Photoshop® Lightroom® and the FUJIFILM Tether Shooting PRO or Tether Shooting plug-ins. The FUJIFILM Tether Shooting PRO and Tether Shooting plug-ins are available from the Adobe add-ons website.

Windows

Tethered shooting is available to purchasers of HS-V5 or of Adobe® Photoshop® Lightroom® and the FUJIFILM Tether Shooting PRO or Tether Shooting plug-ins. The FUJIFILM Tether Shooting PRO and Tether Shooting plug-ins are available from the Adobe add-ons website.

FUJIFILM X Acquire

Tethered shooting is also available to users of FUJIFILM X Acquire, which can be downloaded free-of-charge from the FUJIFILM website.

Copying Pictures to a Computer

Pictures can be copied to Windows and Mac OS X/macOS computers as described below. For information on using the software described, see online help.

Windows

Use MyFinePix Studio to copy pictures to your computer, where they can be stored, viewed, organized, and printed. MyFinePix Studio is available for download from the following website:

<http://fujifilm-dsc.com/mfs/>

Once download is complete, double-click the downloaded file ("MFPS_Setup.EXE") and follow the on-screen instructions to complete installation.

Mac OS X/macOS

Pictures can be copied to your computer using Image Capture (supplied with your computer) or other software.

Viewing RAW Files

To view RAW files on your computer, use the RAW FILE CONVERTER EX 2.0, available for download from:

<http://fujifilm-dsc.com/rfc/>

Connecting the Camera

- 1 Find a memory card containing pictures you want to copy to the computer and insert the card into the camera.

⚠ Loss of power during transfer could result in loss of data or damage to the memory card. Insert a fresh or fully-charged battery before connecting the camera.

- 2 Turn the camera off and connect a third-party USB 3.0 or 2.0 cable (either type can be used), making sure the connectors are fully inserted.

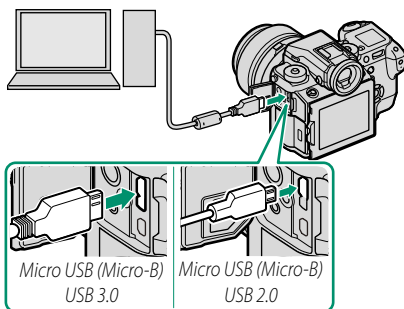

⚠ Use a USB 3.0 cable for higher speeds with computers that support USB 3.0.

- 3 Turn the camera on.
- 4 Copy pictures to your computer. During tethered shooting, you can copy pictures using tethered shooting software such as the FUJIFILM Tethered Shooting Plug-in PRO. Otherwise you can use MyFinePix Studio or applications provided with your operating system.
- 5 When transfer is complete, turn the camera off and disconnect the USB cable.

 If a memory card containing a large number of images is inserted, there may be a delay before the software starts and you may be unable to import or save images. Use a memory card reader to transfer pictures.

The USB cable must be no more than 1.5 m (4.9 ft.) long and be suitable for data transfer. Connect the camera directly to the computer; do not use a USB hub or keyboard.

Do not disconnect the USB cable while data are being exchanged between the camera and computer or insert or remove memory cards while transfer is in progress. Failure to observe this precaution could result in loss of data or damage to the memory card.

In some cases, it may not be possible to access pictures saved to a network server using the software in the same way as on a standalone computer.

The user bears all applicable fees charged by the phone company or Internet service provider when using services that require an Internet connection.

instax SHARE Printers

Print pictures from your digital camera to instax SHARE printers.

Establishing a Connection

Select **CONNECTION SETTING** > **instax PRINTER CONNECTION SETTING** and enter the instax SHARE printer name (SSID) and password.

The Printer Name (SSID) and Password

The printer name (SSID) can be found on the bottom of the printer; the default password is "1111". If you have already chosen a different password to print from a smartphone, enter that password instead.

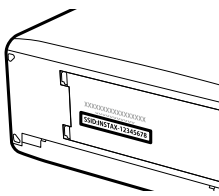

Printing Pictures

- 1 Turn the printer on.
- 2 Select **PLAY BACK MENU > instax PRINTER PRINT**. The camera will connect to the printer.



 To print a frame from a burst sequence, display the frame before selecting **instax PRINTER PRINT**.

- 3 Use the selector to display the picture you want to print, then press **MENU/OK**.



 Pictures taken with other cameras cannot be printed.

The area printed is smaller than the area visible in the LCD monitor.

- 4 The picture will be sent to the printer and printing will start.

12

Technical Notes

Accessories from FUJIFILM

The following optional accessories are available from FUJIFILM. For the latest information on the accessories available in your region, check with your local FUJIFILM representative or visit http://www.fujifilm.com/products/digital_cameras/index.html.

Rechargeable Li-ion batteries

NP-T125: Additional high-capacity NP-T125 rechargeable batteries can be purchased as required.



Battery chargers

BC-T125: Replacement battery chargers can be purchased as required.

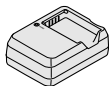

AC power adapters

AC-15V: Use this 100–240 V, 50/60 Hz AC power adapter for extended shooting and playback, when copying pictures to a computer, or to charge the battery in the camera or optional battery grip.



Remote releases

RR-90: Use to reduce camera shake or keep the shutter open during a time exposure.



Stereo microphones

MIC-ST1: An external microphone for movie recording.

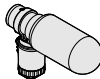

FUJINON lenses

GF-series lenses: Interchangeable lenses for use exclusively with the FUJIFILM G-mount.



Vertical battery grips

VG-GFX1: This grip accommodates an extra battery for improved endurance and makes it easier to hold the camera rotated 90° to frame pictures in “tall” (portrait) orientation. The battery in the grip can be charged using an optional AC-15V AC adapter.

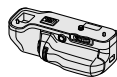
**Tilt adapters**

EVF-TL1: This adapter lets you swivel the viewfinder left or right $\pm 45^\circ$ or up or down between 0° and 90° to take shots from different angles.

**Shoe-mounted flash units**

EF-X500: This clip-on flash unit has a Guide Number of 50/164 (ISO 100, m/ft.) and supports FP (high-speed sync), allowing it to be used at shutter speeds that exceed the flash sync speed. Powered by four AA batteries or an optional EF-BP1 battery pack, it supports manual and TTL flash control and auto power zoom in the range 24–105 mm (35 mm format equivalent) and features FUJIFILM optical wireless flash control, allowing it to be used as a master or remote flash unit for remote wireless flash photography. The flash head can be rotated 90° up, 10° down, 135° left, or 180° right for bounce lighting.



EF-42: This clip-on flash unit (powered by four AA batteries) has a Guide Number of 42/137 (ISO 100, m/ft.) and supports manual and TTL flash control and auto power zoom in the range 24–105 mm (35 mm format equivalent). The flash head can be rotated 90° up, 180° left, or 120° right for bounce lighting.



EF-X20: This clip-on flash unit has a Guide Number of 20/65 (ISO 100, m/ft.). Powered by two AAA batteries, this light, compact unit features a dial for adjusting TTL flash compensation or manual flash output.

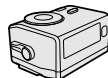

EF-20: This clip-on flash unit (powered by two AA batteries) has a Guide Number of 20/65 (ISO 100, m/ft.) and supports TTL flash control (manual flash control is not supported). The flash head can be rotated upwards 90° for bounce lighting.



Body caps

BCP-002: Cover the camera lens mount when no lens is attached.

instax SHARE printers

SP-1/SP-2: Connect via wireless LAN to print pictures on instax film.

For Your Safety

IMPORTANT SAFETY INSTRUCTIONS

- **Read Instructions:** All the safety and operating instructions should be read before the appliance is operated.
- **Retain Instructions:** The safety and operating instructions should be retained for future reference.
- **Heed Warnings:** All warnings on the appliance and in the operating instructions should be adhered to.
- **Follow Instructions:** All operating and use instructions should be followed.

Installation

Power Sources: This video product should be operated only from the type of power source indicated on the marking label. If you are not sure of the type of power supply to your home, consult your appliance dealer or local power company. For video products intended to operate from battery power, or other sources, refer to the operating instructions.

Grounding or Polarization: This video product is equipped with a polarized alternating-current line plug (a plug having one blade wider than the other). This plug will fit into the power outlet only one way. This is a safety feature. If you are unable to insert the plug fully into the outlet, try reversing the plug. If the plug should still fail to fit, contact your electrician to replace your obsolete outlet. Do not defeat the safety purpose of the polarized plug.

Alternate Warnings: This video product is equipped with a three-wire grounding-type plug, a plug having a third (grounding) pin. This plug will only fit into a grounding-type power outlet. This is a safety feature. If you are unable to insert the plug into the outlet, contact your electrician to replace your obsolete outlet. Do not defeat the safety purpose of the grounding type plug.

Overloading: Do not overload wall outlets and extension cords as this can result in a risk of fire or electric shock.

Ventilation: Slots and openings in the cabinet are provided for ventilation, to ensure reliable operation of the video product and to protect it from overheating, and these openings must not be blocked or covered. The openings should never be blocked by placing the video product on a bed, sofa, rug, or other similar surface.

This video product should not be placed in a built-in installation such as a bookcase or rack unless proper ventilation is provided or the manufacturer's instructions have been adhered to. This video product should never be placed near or over a radiator or heat register.

Attachments: Do not use attachments not recommended by the video product manufacturer as they may cause hazards.

Water and Moisture: Do not use this video product near water—for example, near a bath tub, wash bowl, kitchen sink, or laundry tub, in a wet basement, or near a swimming pool, and the like.

Power-Cord Protection: Power-supply cords should be routed so that they are not likely to be walked on or pinched by items placed upon or against them, paying particular attention to cords at plugs, convenience receptacles, and the point where they exit from the appliance.

Accessories: Do not place this video product on an unstable cart, stand, tripod, bracket, or table. The video product may fall, causing serious injury to a child or adult, and serious damage to the appliance. Use only with a cart, stand, tripod, bracket, or table recommended by the manufacturer, or sold with the video product. Any mounting of the appliance should follow the manufacturer's instructions, and should use a mounting accessory recommended by the manufacturer.

An appliance and cart combination should be moved with care. Quick stops, excessive force, and uneven surfaces may cause the appliance and cart combination to overturn.



Antennas

Outdoor Antenna Grounding: If an outside antenna or cable system is connected to the video product, be sure the antenna or cable system is grounded so as to provide some protection against voltage surges and built-up static charges. Section 810 of the National Electrical Code, ANSI/NFPA No. 70, provides information with respect to proper grounding of the mast and supporting structure, grounding of the lead-in wire to an antenna discharge unit, size of grounding conductors, location of antenna discharge unit, connection to grounding electrodes, and requirements for the grounding electrode.

EXAMPLE OF ANTENNA GROUNDING AS PER NATIONAL ELECTRICAL CODE

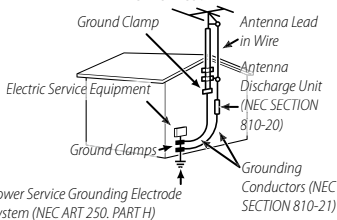

Power Lines: An outside antenna system should not be located in the vicinity of overhead power lines or other electric light or power circuits, or where it can fall into such power lines or circuits. When installing an outside antenna system, extreme care should be taken to keep from touching such power lines or circuits as contact with them might be fatal.

Use

Cleaning: Unplug this video product from the wall outlet before cleaning. Do not use liquid cleaners or aerosol cleaners. Use a damp cloth for cleaning.

Object and Liquid Entry: Never push objects of any kind into this video product through openings as they may touch dangerous voltage points or short out parts that could result in a fire or electric shock. Never spill liquid of any kind on the video product.

Lightning: For added protection for this video product receiver during a lightning storm, or when it is left unattended and unused for long periods of time, unplug it from the wall outlet and disconnect the antenna or cable system. This will prevent damage to the video product due to lightning and power-line surges.

Service

Servicing: Do not attempt to service this video product yourself as opening or removing covers may expose you to dangerous voltage or other hazards. Refer all servicing to qualified service personnel.

Damage Requiring Service: Unplug this video product from the wall outlet and refer servicing to qualified service personnel under the following conditions:

- When the power-supply cord or plug is damaged
- If liquid has been spilled, or objects have fallen into the video product.
- If the video product has been exposed to rain or water.
- If the video product has been dropped or the cabinet has been damaged.

If the video product does not operate normally follow the operating instructions. Adjust only those controls that are covered by the operating instructions as an improper adjustment of other controls may result in damage and will often require extensive work by a qualified technician to restore the video product to its normal operation.

When the video product exhibits a distinct change in performance — this indicates a need for service.

Replacement Parts: When replacement parts are required, be sure the service technician has used replacement parts specified by the manufacturer or have the same characteristics as the original part. Unauthorized substitutions may result in fire, electric shock or other hazards.

Safety Check: Upon completion of any service or repairs to this video product, ask the service technician to perform safety checks to determine that the video product is in proper operating condition.



Be sure to read these notes before use

Safety Notes



- Make sure that you use your camera correctly. Read these safety notes and your *Owner's Manual* carefully before use.
- After reading these safety notes, store them in a safe place.

About the Icons



The icons shown below are used in this document to indicate the severity of the injury or damage that can result if the information indicated by the icon is ignored and the product is used incorrectly as a result.

	WARNING	This icon indicates that death or serious injury can result if the information is ignored.
	CAUTION	This icon indicates that personal injury or material damage can result if the information is ignored.

The icons shown below are used to indicate the nature of the instructions which are to be observed.

	Triangular icons tell you that this information requires attention ("Important").
	Circular icons with a diagonal bar tell you that the action indicated is prohibited ("Prohibited").
	Filled circles with an exclamation mark indicate an action that must be performed ("Required").

The symbols on the product (including the accessories) represent the following:

	AC
	DC
	Class II equipment (The construction of the product is double-insulated.)

WARNING

If a problem arises, turn the camera off, remove the battery, and disconnect and unplug the AC power adapter.



Unplug from power socket

Continued use of the camera when it is emitting smoke, is emitting any unusual odor, or is in any other abnormal state can cause a fire or electric shock. Contact your FUJIFILM dealer.

Do not allow water or foreign objects to enter the camera.





























If water or foreign objects get inside the camera, turn the camera off, remove the battery, and disconnect and unplug the AC power adapter. Continued use of the camera can cause a fire or electric shock. Contact your FUJIFILM dealer.



Do not use in the bathroom or shower

Do not use the camera in the bathroom or shower. This can cause a fire or electric shock.

 WARNING	
	Never attempt to change or take apart the camera (never open the case). Failure to observe this precaution can cause fire or electric shock.
	Should the case break open as the result of a fall or other accident, do not touch the exposed parts. Failure to observe this precaution could result in electric shock or in injury from touching the damaged parts. Remove the battery immediately, taking care to avoid injury or electric shock, and take the product to the point of purchase for consultation.
	Do not change, heat or unduly twist or pull the connection cord and do not place heavy objects on the connection cord. These actions could damage the cord and cause a fire or electric shock. If the cord is damaged, contact your FUJIFILM dealer.
	Do not place the camera on an unstable surface. This can cause the camera to fall or tip over and cause injury.
	Never attempt to take pictures while in motion. Do not use the camera while walking or driving. This can result in you falling down or being involved in a traffic accident.
	Do not touch any metal parts of the camera during a thunderstorm. This can cause an electric shock due to induced current from the lightning discharge.
	Do not use the battery except as specified. Load the battery as shown by the indicator.
	Do not disassemble, modify, or heat batteries. Do not drop, strike, or throw batteries or otherwise subject them to strong impacts. Do not use batteries that show signs of leaking, deformation, discoloration, or other abnormalities. Use only designated chargers to recharge rechargeable batteries and do not attempt to recharge non-rechargeable Li-ion or alkaline batteries. Do not short batteries or store them with metallic objects. Failure to observe these precautions could result in the batteries overheating, igniting, rupturing, or leaking, causing fire, burns, or other injury.
	Use only batteries or AC power adapters specified for use with this camera. Do not use voltages other than the power supply voltage shown. The use of other power sources can cause a fire.
	If the battery leaks and fluid gets in contact with your eyes, skin or clothing, flush the affected area with clean water and seek medical attention or call an emergency number right away.
	Do not use the charger to charge batteries other than those specified here. The supplied charger is for use only with batteries of the type supplied with the camera. Using the charger to charge conventional batteries or other types of rechargeable batteries can cause the battery to leak, overheat or burst.

 WARNING	
	Using a flash too close to a person's eyes may cause visual impairment. Take particular care when photographing infants and young children.
	Do not remain in prolonged contact with hot surfaces. Failure to observe this precaution could result in low-temperature burns, particularly at high ambient temperatures or with users who suffer from poor circulation or reduced sensation, in which case use of a tripod or similar precautions are recommended.
	Do not leave one part of the body in contact with the product for prolonged periods while the product is on. Failure to observe this precaution could result in low-temperature burns, particularly during prolonged use, at high ambient temperatures, or with users who suffer from poor circulation or reduced sensation, in which case use of a tripod or similar precautions are recommended.
	Do not use in the presence of flammable objects, explosive gases, or dust.
	When carrying the battery, install it in a digital camera or keep it in the hard case. When storing the battery, keep it in the hard case. When discarding, cover the battery terminals with insulation tape. Contact with other metallic objects or batteries could cause the battery to ignite or burst.
	Keep memory cards, hot shoes, and other small parts out of the reach of small children. Children may swallow small parts; keep out of reach of children. Should a child swallow a small part, seek medical attention or call emergency.
	Keep out of reach of small children. Among the elements that could cause injury are the strap, which could become entangled about a child's neck, causing strangulation, and the flash, which could cause visual impairment.
	Follow the directions of airline and hospital personnel. This product generates radio-frequency emissions that could interfere with navigational or medical equipment.
 CAUTION	
	Do not use this camera in locations affected by oil fumes, steam, humidity or dust. This can cause a fire or electric shock.
	Do not leave this camera in places subject to extremely high temperatures. Do not leave the camera in locations such as a sealed vehicle or in direct sunlight. This can cause a fire.
	Do not place heavy objects on the camera. This can cause the heavy object to tip over or fall and cause injury.
	Do not move the camera while the AC power adapter is still connected. Do not pull on the connection cord to disconnect the AC power adapter. This can damage the power cord or cables and cause a fire or electric shock.

CAUTION

Do not cover or wrap the camera or the AC power adapter in a cloth or blanket. This can cause heat to build up and distort the casing or cause a fire.



When you are cleaning the camera or you do not plan to use the camera for an extended period, remove the battery and disconnect and unplug the AC power adapter. Failure to do so can cause a fire or electric shock.



When charging ends, unplug the charger from the power socket. Leaving the charger plugged into the power socket can cause a fire.

CAUTION

When a memory card is removed, the card could come out of the slot too quickly. Use your finger to hold it and gently release the card. Injury could result to those struck by the ejected card.



Request regular internal testing and cleaning for your camera. Build-up of dust in your camera can cause a fire or electric shock. Contact your FUJIFILM dealer to request internal cleaning every two years. Please note that this service is not free of charge.



Danger of explosion if battery is incorrectly replaced. Replace only with the same or equivalent type.

The Battery and Power Supply

Note: Check the type of battery used in your camera and read the appropriate sections.

WARNING Battery shall not be exposed to excessive heat such as sunshine, fire or the like.

The following describes the proper use of batteries and how to prolong their life. Incorrect use can shorten battery life or cause leakage, overheating, fire, or explosion.

Li-ion Batteries

Read this section if your camera uses a rechargeable Li-ion battery.

The battery is not charged at shipment. Charge the battery before use. Keep the battery in its case when not in use.

Notes on the Battery

The battery gradually loses its charge when not in use. Charge the battery one or two days before use.

Battery life can be extended by turning the camera off when not in use.

Battery capacity decreases at low temperatures; a depleted battery may not function when cold. Keep a fully charged spare battery in a warm place and exchange as necessary, or keep the battery in your pocket or other warm place and insert it in the camera only when shooting. Do not place the battery in direct contact with hand warmers or other heating devices.

Charging the Battery

Charge the battery in the supplied battery charger. Charging times will increase at ambient temperatures below +10°C (+50°F) or above +35°C (+95°F). Do not attempt to charge the battery at temperatures above +40°C (+104°F); at temperatures below +5°C (+41°F), the battery will not charge.

Do not attempt to recharge a fully charged battery. The battery does not however need to be fully discharged before charging. The battery may be warm to the touch immediately after charging or use. This is normal.

Battery Life

At normal temperatures, the battery can be recharged about 300 times. A noticeable decrease in the length of time the battery will hold a charge indicates that it has reached the end of its service life and should be replaced.

Storage

Performance may be impaired if the battery is left unused for extended periods when fully charged. Run the battery flat before storing it.

If the camera will not be used for an extended period, remove the battery and store it in a dry place with an ambient temperature of from +15°C to +25°C (+59°F to +77°F). Do not store in locations exposed to extremes of temperature.

Cautions: Handling the Battery

- Do not transport or store with metal objects such as necklaces or hairpins.
- Do not expose to flame or heat.
- Do not disassemble or modify.
- Use with designated chargers only.
- Dispose of used batteries promptly.
- Do not drop or subject to strong physical shocks.
- Do not expose to water.
- Keep the terminals clean.
- The battery and camera body may become warm to the touch after extended use. This is normal.

Caution: Disposal

Dispose of used batteries in accord with local regulations. Attention should be drawn to the environmental aspects of battery disposal. Use the apparatus under moderate climate.

AC Power Adapters (Available Separately)

Use only FUJIFILM AC power adapters designated for use with this camera. Other adapters could damage the camera.

- The AC power adapter is for indoor use only.
- Be sure the DC plug is securely connected to the camera.
- Turn the camera off before disconnecting the adapter. Disconnect the adapter by the plug, not the cable.
- Do not use with other devices.
- Do not disassemble.
- Do not expose to high heat and humidity.
- Do not subject to strong physical shocks.
- The adapter may hum or become hot to the touch during use. This is normal.
- If the adapter causes radio interference, reorient or relocate the receiving antenna.

Using the Camera

- Do not aim the camera at extremely bright light sources, such as the sun in a cloudless sky. Failure to observe this precaution could damage the camera image sensor.
- Strong sunlight focused through the viewfinder may damage the panel of electronic viewfinder (EVF). Do not aim the electronic viewfinder at the sun.

Take Test Shots

Before taking photographs on important occasions (such as at weddings or before taking the camera on a trip), take a test shot and view the results to ensure that the camera is functioning normally. FUJIFILM Corporation cannot accept liability for damages or lost profits incurred as a result of product malfunction.

Notes on Copyright

Unless intended solely for personal use, images recorded using your digital camera system cannot be used in ways that infringe copyright laws without the consent of the owner. Note that some restrictions apply to the photographing of stage performances, entertainments, and exhibits, even when intended purely for personal use. Users are also asked to note that the transfer of memory cards containing images or data protected under copyright laws is only permissible within the restrictions imposed by those copyright laws.

Handling

To ensure that images are recorded correctly, do not subject the camera to impact or physical shocks while images are being recorded.

Liquid Crystal

In the event that the display is damaged, care should be taken to avoid contact with liquid crystal. Take the urgent action indicated should any of the following situations arise:

- **If liquid crystal comes in contact with your skin**, clean the area with a cloth and then wash thoroughly with soap and running water.
- **If liquid crystal enters your eyes**, flush the affected eye with clean water for at least 15 minutes and then seek medical assistance.
- **If liquid crystal is swallowed**, rinse your mouth thoroughly with water. Drink large quantities of water and induce vomiting, then seek medical assistance.

Although the display is manufactured using extremely high-precision technology, it may contain pixels that are always lit or that do not light. This is not a malfunction, and images recorded with the product are unaffected.

Trademark Information

Digital Split Image is a trademark or registered trademark of FUJIFILM Corporation. xD-Picture Card and  are trademarks of FUJIFILM Corporation. The typefaces included herein are solely developed by DynaComware Taiwan Inc. Macintosh, Mac OS, and macOS are trademarks of Apple Inc. in the U.S.A. and other countries. Windows is a registered trademark of Microsoft Corporation in the U.S.A. and other countries. Adobe, the Adobe logo, Photoshop, and Lightroom are trademarks or registered trademarks of Adobe Systems Incorporated in the U.S.A. and other countries. Wi-Fi® and Wi-Fi Protected Setup® are registered trademarks of the Wi-Fi Alliance. The SDHC and SDXC logos are trademarks of SD-3C, LLC. The HDMI logo is a trademark. All other trade names mentioned in this manual are the trademarks or registered trademarks of their respective owners.

Electrical Interference

This camera may interfere with hospital or aviation equipment. Consult with hospital or airline staff before using the camera in a hospital or on an aircraft.

Color Television Systems

NTSC (National Television System Committee) is a color television telecasting specification adopted mainly in the U.S.A., Canada, and Japan. PAL (Phase Alternation by Line) is a color television system adopted mainly in European countries and China.

Exif Print (Exif Version 2.3)

Exif Print is a newly revised digital camera file format in which information stored with photographs is used for optimal color reproduction during printing.

IMPORTANT NOTICE: Read Before Using the Software

Direct or indirect export, in whole or in part, of licensed software without the permission of the applicable governing bodies is prohibited.

NOTICES

To prevent fire or shock hazard, do not expose the unit to rain or moisture.

Please read the "Safety Notes" and make sure you understand them before using the camera.

Perchlorate Material—special handling may apply. See:

<http://www.dtscc.ca.gov/hazardouswaste/perchlorate>

For Customers in the U.S.A.

Tested To Comply With FCC Standards FOR HOME OR OFFICE USE



Contains IC : 7736B-02000003

Contains FCC ID : W22-02000003

FCC Statement: This device complies with Part 15 of the FCC Rules. Operation is subject to the following two conditions: (1) This device may not cause harmful interference, and (2) this device must accept any interference received, including interference that may cause undesired operation.

CAUTION: This equipment has been tested and found to comply with the limits for a Class B digital device, pursuant to Part 15 of the FCC Rules. These limits are designed to provide reasonable protection against harmful interference in a residential installation. This equipment generates, uses, and can radiate radio frequency energy and, if not installed and used in accordance with the instructions, may cause harmful interference to radio communications. However, there is no guarantee that interference will not occur in a particular installation. If this equipment does cause harmful interference to radio or television reception, which can be determined by turning the equipment off and on, the user is encouraged to try to correct the interference by one or more of the following measures:

- Reorient or relocate the receiving antenna.
- Increase the separation between the equipment and receiver.
- Connect the equipment into an outlet on a circuit different from that to which the receiver is connected.
- Consult the dealer or an experienced radio/TV technician for help.

FCC Caution: Any changes or modifications not expressly approved by the party responsible for compliance could void the user's authority to operate this equipment.

This transmitter must not be co-located or operating in conjunction with any other antenna or transmitter.

Radiation Exposure Statement: This device meets the government's requirements for exposure to radio waves. This device is designed and manufactured not to exceed the emission limits for exposure to radio frequency (RF) energy set by the Federal Communications Commission of the U.S. Government.

The exposure standard for wireless device employs a unit of measurement known as the Specific Absorption Rate, or SAR. The SAR limit set by the FCC is 1.6W/kg. Tests for SAR are conducted using standard operating positions accepted by the FCC with the device transmitting at its highest certified power level in all tested frequency bands.

Notes on the Grant: To comply with Part 15 of the FCC Rules, this product must be used with a Fujifilm-specified ferrite-core A/V cable, USB cable, and DC supply cord.



A lithium ion battery that is recyclable powers the product you have purchased. Please call 1-800-8-BATTERY for information on how to recycle this battery.

For Customers in Canada**CAN ICES-3 (B)/NMB-3(B)**

CAUTION: This Class B digital apparatus complies with Canadian ICES-003.

Industry Canada statement: This device complies with Industry Canada's licence-exempt RSSs. Operation is subject to the following two conditions: (1) This device may not cause interference; and (2) This device must accept any interference, including interference that may cause undesired operation of the device.

This device and its antenna(s) must not be co-located or operating in conjunction with any other antenna or transmitter, except tested built-in radios. The County Code Selection feature is disabled for products marketed in the US/ Canada.

Radiation Exposure Statement: The available scientific evidence does not show that any health problems are associated with using low power wireless devices. There is no proof, however, that these low power wireless devices are absolutely safe. Low power Wireless devices emit low levels of radio frequency energy (RF) in the microwave range while being used. Whereas high levels of RF can produce health effects (by heating tissue), exposure of low-level RF that does not produce heating effects causes no known adverse health effects. Many studies of low-level RF exposures have not found any biological effects. Some studies have suggested that some biological effects might occur, but such findings have not been confirmed by additional research. GFX 505 has been tested and found to comply with IC radiation exposure limits set forth for an uncontrolled environment and meets RSS-102 of the IC radio frequency (RF) Exposure rules.

Disposal of Electrical and Electronic Equipment in Private Households**In the European Union, Norway, Iceland and Liechtenstein:**

This symbol on the product, or in the manual and in the warranty, and/or on its packaging indicates that this product shall not be treated as household waste. Instead it should be taken to an applicable collection point for the recycling of electrical and electronic equipment.

By ensuring this product is disposed of correctly, you will help prevent potential negative consequences to the environment and human health, which could otherwise be caused by inappropriate waste handling of this product.

This symbol on the batteries or accumulators indicates that those batteries shall not be treated as household waste.

If your equipment contains easy removable batteries or accumulators please dispose these separately according to your local requirements.

The recycling of materials will help to conserve natural resources. For more detailed information about recycling this product, please contact your local city office, your household waste disposal service or the shop where you purchased the product.

In Countries Outside the European Union, Norway, Iceland and Liechtenstein:

If you wish to discard this product, including the batteries or accumulators, please contact your local authorities and ask for the correct way of disposal.

In Japan: This symbol on the batteries indicates that they are to be disposed of separately.



Wireless Network Devices: Cautions

This product complies with the following EU Directives:

- RoHS Directive 2011/65/EU
- RE Directive 2014/53/EU

Hereby, FUJIFILM Corporation declares that the radio equipment type FF160005 is in compliance with Directive 2014/53/EU.

The full text of the EU declaration of conformity is available at the following internet address: http://www.fujifilm.com/products/digital_cameras/gfx/fujifilm_gfx_50s/pdf/index/fujifilm_gfx_50s_cod.pdf

This compliance is indicated by the following conformity marking placed on the product:



This marking is valid for non-Telecom products and EU harmonized Telecom products (e.g. Bluetooth).

IMPORTANT: Read the following notices before using the camera's built-in wireless transmitter.

Ⓢ This product, which contains encryption function developed in the United States, is controlled by the United States Export Administration Regulations and may not be exported or re-exported to any country to which the United States embargoes goods.

• **Use only as part of a wireless network.** FUJIFILM does not accept liability for damages resulting from unauthorized use. Do not use in applications requiring a high degree of reliability, for example in medical devices or other systems that may directly or indirectly impact human life. When using the device in computer and other systems that demand a greater degree of reliability than wireless networks, be sure to take all necessary precautions to ensure safety and prevent malfunction.

• **Use only in the country in which the device was purchased.** This device conforms to regulations governing wireless network devices in the country in which it was purchased. Observe all location regulations when using the device. FUJIFILM does not accept liability for problems arising from use in other jurisdictions.

• **Do not use the device in locations subject to magnetic fields, static electricity, or radio interference.** Do not use the transmitter in the vicinity of microwave ovens or in other locations subject to magnetic fields, static electricity, or radio interference that may prevent reception of wireless signals. Mutual interference may occur when the transmitter is used in the vicinity of other wireless devices operating in the 2.4 GHz band.

• **The wireless transmitter operates in the 2.4 GHz band using DSSS and OFDM modulation.**

• **This device operates on the same frequency as commercial, educational, and medical devices and wireless transmitters.** It also operates on the same frequency as licensed transmitters and special unlicensed low-voltage transmitters used in RFID tracking systems for assembly lines and in other similar applications.

• **To prevent interference with the above devices, observe the following precautions.** Confirm that the RFID transmitter is not in operation before using this device. Should you observe that the device causes interference in licensed transmitters used for RFID tracking, immediately stop using the affected frequency or move the device to another location. If you notice that this device causes interference in low-voltage RFID tracing systems, contact a FUJIFILM representative.



Be sure to read these notes before use

Safety Notes



- Make sure that you use the lens correctly. Read these safety notes and the camera *Owner's Manual* carefully before use.
- After reading these safety notes, store them in a safe place.

About the Icons

The icons shown below are used in this document to indicate the severity of the injury or damage that can result if the information indicated by the icon is ignored and the product is used incorrectly as a result.

	WARNING This icon indicates that death or serious injury can result if the information is ignored.
	CAUTION This icon indicates that personal injury or material damage can result if the information is ignored.

The icons shown below are used to indicate the nature of the instructions which are to be observed.

	Triangular icons tell you that this information requires attention ("Important").
	Circular icons with a diagonal bar tell you that the action indicated is prohibited ("Prohibited").
	Filled circles with an exclamation mark indicate an action that must be performed ("Required").

 **WARNING**

	Do not immerse in or expose to water. Failure to observe this precaution can cause a fire or electric shock.
	Do not disassemble (do not open the case). Failure to observe this precaution can cause fire, electric shock, or injury due to product malfunction.
	Should the case break open as the result of a fall or other accident, do not touch the exposed parts. Failure to observe this precaution could result in electric shock or in injury from touching the damaged parts. Remove the battery immediately, taking care to avoid injury or electric shock, and take the product to the point of purchase for consultation.
	Do not place on unstable surfaces. The product may fall, causing injury.
	Do not view the sun through the lens or camera viewfinders. Failure to observe this precaution can cause permanent visual impairment.

 **CAUTION**

	Do not use or store in locations that are exposed to steam, or smoke or are very humid or extremely dusty. Failure to observe this precaution can cause fire or electric shock.
	Do not leave in direct sunlight or in locations subject to very high temperatures, such as in a closed vehicle on a sunny day. Failure to observe this precaution can cause fire.
	Keep out of the reach of small children. This product could cause injury in the hands of a child.
	Do not handle with wet hands. Failure to observe this precaution can cause electric shock.
	Keep the sun out of the frame when shooting backlit subjects. Sunlight focused into the camera when the sun is in or close to the frame can cause fire or burns.
	When the product is not in use, replace the lens caps and store out of direct sunlight. Sunlight focused by the lens can cause fire or burns.
	Do not carry the camera or lens while they are attached to a tripod. The product can fall or strike other objects, causing injury.

Product Care

To ensure continued enjoyment of the product, observe the following precautions.

Camera body: Use a soft, dry cloth to clean the camera body after each use. Do not use alcohol, thinner, or other volatile chemicals, which could discolor or deform the leather on the camera body. Any liquid on the camera should be removed immediately with a soft, dry cloth. Use a blower to remove dust from the monitor, taking care to avoid scratches, and then gently wipe with a soft, dry cloth. Any remaining stains can be removed by wiping gently with a piece of FUJIFILM lens-cleaning paper to which a small amount of lens-cleaning fluid has been applied. To prevent dust entering the camera, replace the body cap when no lens is in place.

Image sensor: Multiple photographs marred by spots or blotches in identical locations may indicate the presence of dust on the image sensor. Clean the sensor using  **USER SETTING > SENSOR CLEANING.**

Cleaning the Image Sensor

Dust that cannot be removed using **USER SETTING > SENSOR CLEANING** can be removed manually as described below.

! Note that there will be a charge to repair or replace the image sensor if it is damaged during cleaning.

- 1** Use a blower (not a brush) to remove dust from the sensor.

! Do not use a brush or blower brush. Failure to observe this precaution could damage the sensor.

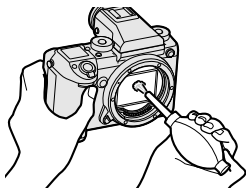

- 2** Check whether the dust has been successfully removed. Repeat Steps 1 and 2 as necessary.
- 3** Replace the body cap or lens.

Firmware Updates

Updates to product firmware may result in changes not described in the manual. For more information, visit: http://www.fujifilm.com/support/digital_cameras/software

Checking the Firmware Version

 The camera will only display the firmware version if a memory card is inserted.

- 1 Turn the camera off and check that a memory card is inserted.
- 2 Turn the camera on while holding the **DISP/BACK** button. The current firmware version will be displayed; check the firmware version.
- 3 Turn the camera off.

Troubleshooting

Consult the table below should you encounter problems using your camera. If you don't find the solution here, contact your local FUJIFILM distributor.

Power and Battery

Problem	Solution
The camera does not turn on.	<ul style="list-style-type: none">• The battery is exhausted: Charge the battery or insert a fully-charged spare battery (📖 27).• The battery is inserted incorrectly: Reinsert in the correct orientation (📖 30).• The battery-chamber cover is not latched: Latch the battery-chamber cover (📖 30).
The monitor does not turn on.	The monitor may not turn on if the camera is turned off and then on again very quickly. Press the shutter button halfway to activate the monitor.
The battery runs down quickly.	<ul style="list-style-type: none">• The battery is cold: Warm the battery by placing it in a pocket or other warm place and reinsert it in the camera immediately before taking a picture.• There is dirt on the battery terminals: Clean the terminals with a soft, dry cloth.• ON is selected for  AF/MF SETTING > PRE-AF: Turn PRE-AF off (📖 99).• The battery has been charged many times: The battery has reached the end of its charging life. Purchase a new battery.
The camera turns off suddenly.	The battery is exhausted: Charge the battery or insert a fully-charged spare battery (📖 27).
Charging does not start.	Reinsert the battery in the correct orientation and make sure that the charger is plugged in (📖 27, 30).
Charging is slow.	Charge the battery at room temperature.

Problem	Solution
The charging lamp blinks, but the battery does not charge.	<ul style="list-style-type: none"> • There is dirt on the battery terminals: Clean the terminals with a soft, dry cloth (📖 30). • The battery has been charged many times: The battery has reached the end of its charging life. Purchase a new battery. If the battery still fails to charge, contact your FUJIFILM dealer (📖 218).

Menus and Displays

Problem	Solution
Display is not in English.	Select ENGLISH for USER SETTING > 言語/LANG. (📖 38, 148).

Shooting

Problem	Solution
No picture is taken when the shutter button is pressed.	<ul style="list-style-type: none"> • The memory card is full: Insert a new memory card or delete pictures (📖 32, 129). • The memory card is not formatted: Format the memory card (📖 146). • There is dirt on the memory card contacts: Clean the contacts with a soft, dry cloth. • The memory card is damaged: Insert a new memory card (📖 32). • The battery is exhausted: Charge the battery or insert a fully-charged spare battery (📖 27). • The camera has turned off automatically: Turn the camera on (📖 35). • You are using a third-party mount adapter: Select ON for SHOOT WITHOUT LENS (📖 165).
Mottling (“noise”) appears in the monitor or viewfinder when the shutter button is pressed halfway.	Gain is increased to aid composition when the subject is poorly lit and aperture is stopped down, which may result in noticeable mottling when images are previewed in the displays. Images taken with the camera are unaffected.
The camera does not focus.	The subject is not suited to autofocus: Use focus lock or manual focus (📖 78).

Problem	Solution
No face is detected.	<ul style="list-style-type: none"> • The subject's face is obscured by sunglasses, a hat, long hair, or other objects: Remove the obstructions (📖 100). • The subject's face occupies only a small area of the frame: Change the composition so that the subject's face occupies a larger area of the frame (📖 100). • The subject's head is tilted or horizontal: Ask the subject to hold their head straight (📖 100). • The camera is tilted: Keep the camera level. • The subject's face is poorly lit: Shoot in bright light.
Wrong subject is selected.	The selected subject is closer to the center of the frame than the main subject. Recompose the picture or turn face detection off and frame the picture using focus lock (📖 78).
The flash does not fire.	The battery is exhausted: Charge the battery or insert a fully-charged spare battery (📖 27).
The flash does not fully light the subject.	<ul style="list-style-type: none"> • The subject is not in range of the flash: Position the subject in range of the flash. • The flash window is obstructed: Hold the camera correctly. • Shutter speed is faster than the sync speed: Choose a slower shutter speed (📖 54, 60, 244).
Pictures are blurred.	<ul style="list-style-type: none"> • The lens is dirty: Clean the lens (📖 189). • The lens is blocked: Keep objects away from the lens (📖 41). • !AF is displayed during shooting and the focus frame is displayed in red: Check focus before shooting (📖 42).
Pictures are mottled.	<ul style="list-style-type: none"> • Shutter speed is slow and the ambient temperature is high: This is normal and does not indicate a malfunction. • Pixel mapping is required: Perform pixel mapping using 📷 IMAGE QUALITY SETTING > PIXEL MAPPING (📖 95). • The camera has been used continuously at high temperatures or a temperature warning is displayed: Turn the camera off and wait for it to cool down (📖 35, 241).

Playback

Problem	Solution
Pictures are grainy.	The pictures were taken with a different make or model of camera.
Playback zoom is unavailable.	The pictures were created using RESIZE or with a different make or model of camera.
No sound in movie playback.	<ul style="list-style-type: none">• Playback volume is too low: Adjust playback volume (📖 152).• The microphone was obstructed: Hold the camera correctly during recording.• The speaker is obstructed: Hold the camera correctly during playback.
Selected pictures are not deleted.	Some of the pictures selected for deletion are protected. Remove protection using the device with which it was originally applied (📖 133).
File numbering is unexpectedly reset.	The battery-chamber cover was opened while the camera was on. Turn the camera off before opening the battery-chamber cover (📖 169).

Connections

Problem	Solution
The monitor is blank.	The camera is connected to a TV: Pictures will be displayed on the TV instead of in the camera monitor (📖 16, 208).
No picture or sound on TV.	<ul style="list-style-type: none">• The camera is not properly connected: Connect the camera properly (📖 16, 208).• Input on the television is set to “TV”: Set input to “HDMI” (📖 16, 208).• The volume on the TV is too low: Use the controls on the television to adjust the volume (📖 16, 208).
Both the TV and camera monitor are blank.	The display mode selected with the VIEW MODE button is EVF ONLY + : Put your eye to the viewfinder or use the VIEW MODE button to choose another display mode.
The computer does not recognize the camera.	Be sure the camera and computer are correctly connected (📖 211).
Cannot transfer RAW or JPEG files to computer.	Use MyFinePix Studio to transfer pictures (Windows only; 📖 211).

Wireless Transfer

For additional information on troubleshooting wireless connections, visit: <http://digital-cameras.support.fujifilm.com/app?pid=x>



Problem	Solution
Problem connecting or uploading pictures to smartphone.	<ul style="list-style-type: none"> • The smartphone is too far away: Move the devices closer (📖 210). • Nearby devices are causing radio interference: Move the camera and smartphone away from microwave ovens or cordless phones (📖 210).
Cannot upload images.	<ul style="list-style-type: none"> • The smartphone is connected to another device: The smartphone and camera can connect to only one device at a time. End the connection and try again (📖 210). • There are several smartphones in the vicinity: Try connecting again. The presence of multiple smartphones can make connection difficult (📖 210). • The current image is a movie or was created on another device and cannot be uploaded to a smartphone (📖 210).
Smartphone will not display pictures.	Select ON for 📷 CONNECTION SETTING > WIRELESS SETTINGS > RESIZE IMAGE FOR SMARTPHONE 📷 . Selecting OFF increases upload times for larger images; in addition, some phones may not display images over a certain size (📖 172).



Miscellaneous

Problem	Solution
The camera is unresponsive.	<ul style="list-style-type: none"> • Temporary camera malfunction: Remove and reinsert the battery (📖 30). • The battery is exhausted: Charge the battery or insert a fully-charged spare battery (📖 27). • The camera is connected to a wireless LAN: End the connection. • The controls are locked: Press and hold the MENU/OK button to unlock the controls (📖 5). • Tethered shooting is in progress: Camera controls cannot be used while tethered shooting is in progress. Choose a different operating mode (📖 174).
The camera does not function as expected.	Remove and reinsert the battery (📖 30). If the problem persists, contact your FUJIFILM dealer.
No sound.	Adjust the volume (📖 151).
The EVF does not turn on.	The EVF is not correctly attached: Slide the EVF on until it clicks into place (📖 11).

Warning Messages and Displays

The following warnings appear in the display.



Warning	Description
 (red)	Low battery. Charge the battery or insert a fully-charged spare battery.
 (blinks red)	Battery exhausted. Charge the battery or insert a fully-charged spare battery.
!AF (displayed in red with red focus frame)	The camera cannot focus. Use focus lock to focus on another subject at the same distance, then recompose the picture.
Aperture or shutter speed displayed in red	The subject is too bright or too dark and the picture will be over- or under-exposed. Use the flash for additional lighting when taking photographs of poorly-lit subject.
FOCUS ERROR	Camera malfunction. Turn the camera off and then on again. If the message persists, contact a FUJIFILM dealer.
LENS CONTROL ERROR	
TURN OFF THE CAMERA AND TURN ON AGAIN	
NO CARD	The shutter can only be released when a memory card is inserted. Insert a memory card.
CARD NOT INITIALIZED	<ul style="list-style-type: none">• The memory card is not formatted or the memory card has been formatted in a computer or other device: Format the memory card using  USER SETTING > FORMAT.• The memory card contacts require cleaning: Clean the contacts with a soft, dry cloth. If the message is repeated, format the card. If the message persists, replace the card.• Camera malfunction: Contact a FUJIFILM dealer.
LENS ERROR	Turn the camera off, remove the lens, and clean the mounting surfaces, then replace the lens and turn the camera on. If the problem persists, contact a FUJIFILM dealer.

Warning	Description
CARD ERROR	<ul style="list-style-type: none"> • The memory card is not formatted for use in the camera: Format the card. • The memory card contacts require cleaning or the memory card is damaged: Clean the contacts with a soft, dry cloth. If the message is repeated, format the card. If the message persists, replace the card. • Incompatible memory card: Use a compatible card. • Camera malfunction: Contact a FUJIFILM dealer.
PROTECTED CARD	The memory card is locked. Unlock the card.
BUSY	The memory card is incorrectly formatted. Use the camera to format the card.
 MEMORY FULL	The memory card is full and pictures cannot be recorded. Delete pictures or insert a memory card with more free space.
WRITE ERROR	<ul style="list-style-type: none"> • Memory card error or connection error: Reinsert the card or turn the camera off and then on again. If the message persists, contact a FUJIFILM dealer. • Not enough memory remaining to record additional pictures: Delete pictures or insert a memory card with more free space. • The memory card is not formatted: Format the memory card.
FRAME NO. FULL	The camera has run out of frame numbers (current frame number is 999-9999). Format the memory card and select RENEW for  SAVE DATA SET-UP > FRAME NO. Take a picture to reset frame numbering to 100-0001, then select CONTINUOUS for FRAME NO.

Warning	Description
READ ERROR	<ul style="list-style-type: none"> • The file is corrupt or was not created with the camera: The file cannot be viewed. • The memory card contacts require cleaning: Clean the contacts with a soft, dry cloth. If the message is repeated, format the card. If the message persists, replace the card. • Camera malfunction: Contact a FUJIFILM dealer.
PROTECTED FRAME	An attempt was made to delete or rotate to a protected picture. Remove protection and try again.
CAN NOT CROP	The picture is damaged or was not created with the camera.
DPOF FILE ERROR	Print orders can contain no more than 999 pictures. Copy any additional pictures you wish to print to another memory card and create a second print order.
CAN NOT ROTATE	The selected picture cannot be rotated.
🎞️ CAN NOT ROTATE	Movies cannot be rotated.
CAN NOT SET DPOF	The picture cannot be printed using DPOF.
🎞️ CAN NOT SET DPOF	Movies cannot be printed using DPOF.
👁️ CANNOT EXECUTE	Red-eye removal cannot be applied to movies.
👁️ CANNOT EXECUTE	Red-eye removal cannot be applied to pictures created with other devices.
!🔊 (yellow)	Turn the camera off and wait for it to cool. Mottling may increase in pictures taken when this warning is displayed.
!🔊 (red)	Turn the camera off and wait for it to cool. While this warning is displayed, movies cannot be recorded, mottling may increase, and performance, including frame advance rate and display quality, may drop.

Memory Card Capacity

The following table shows the recording time or number of pictures available at different image sizes. All figures are approximate; file size varies with the scene recorded, producing wide variations in the number of files that can be stored. The number of exposures or length remaining may not diminish at an even rate.

		Capacity	8 GB			16 GB		
			SUPER FINE	FINE	NORMAL	SUPER FINE	FINE	NORMAL
Photos	 4:3		254	381	607	524	785	1253
	RAW (UNCOMPRESSED)		66			137		
	RAW (LOSSLESS COMPRESSED)		127			265		
Movies	 1080/29.97P, 25P, 24P, 23.98P		26 minutes			54 minutes		
	 720/29.97P, 25P, 24P, 23.98P		51 minutes			105 minutes		

* Use a UHS speed class 1 card or better. Individual movies cannot exceed 30 minutes in length.





 Although movie recording will continue without interruption when the file size reaches 4 GB, subsequent footage will be recorded to a separate file which must be viewed separately.

Specifications









System																	
Model	FUJIFILM GFX 50S																
Product Number	FF160005																
Effective pixels	Approx. 51.4 million																
Image sensor	43.8 mm × 32.9 mm Bayer array with primary color filter																
Storage media	FUJIFILM-recommended SD/SDHC/SDXC memory cards																
Memory card slots	Two SD memory card slots (UHS-II compliant)																
File system	Compliant with Design Rule for Camera File System (DCF), Exif 2.3, and Digital Print Order Format (DPOF)																
File format	<ul style="list-style-type: none"> • Still pictures: Exif 2.3 JPEG (compressed); RAW (original RAF format, uncompressed or compressed using a lossless algorithm; special purpose software required); RAW+JPEG available; TIFF (RGB) • Movies: H.264 standard with stereo sound (MOV) • Audio (voice memos): Stereo sound (WAV) 																
Image size	<table border="0"> <tbody> <tr> <td>L 4:3 (8256 × 6192)</td> <td>S 4:3 (4000 × 3000)</td> </tr> <tr> <td>L 3:2 (8256 × 5504)</td> <td>S 3:2 (4000 × 2664)</td> </tr> <tr> <td>L 16:9 (8256 × 4640)</td> <td>S 16:9 (4000 × 2248)</td> </tr> <tr> <td>L 1:1 (6192 × 6192)</td> <td>S 1:1 (2992 × 2992)</td> </tr> <tr> <td>L 65:24 (8256 × 3048)</td> <td>S 65:24 (4000 × 1480)</td> </tr> <tr> <td>L 5:4 (7744 × 6192)</td> <td>S 5:4 (3744 × 3000)</td> </tr> <tr> <td>L 7:6 (7232 × 6192)</td> <td>S 7:6 (3504 × 3000)</td> </tr> <tr> <td>RAW (8256 × 6192)</td> <td>TIFF (8256 × 6192)</td> </tr> </tbody> </table>	L 4:3 (8256 × 6192)	S 4:3 (4000 × 3000)	L 3:2 (8256 × 5504)	S 3:2 (4000 × 2664)	L 16:9 (8256 × 4640)	S 16:9 (4000 × 2248)	L 1:1 (6192 × 6192)	S 1:1 (2992 × 2992)	L 65:24 (8256 × 3048)	S 65:24 (4000 × 1480)	L 5:4 (7744 × 6192)	S 5:4 (3744 × 3000)	L 7:6 (7232 × 6192)	S 7:6 (3504 × 3000)	RAW (8256 × 6192)	TIFF (8256 × 6192)
L 4:3 (8256 × 6192)	S 4:3 (4000 × 3000)																
L 3:2 (8256 × 5504)	S 3:2 (4000 × 2664)																
L 16:9 (8256 × 4640)	S 16:9 (4000 × 2248)																
L 1:1 (6192 × 6192)	S 1:1 (2992 × 2992)																
L 65:24 (8256 × 3048)	S 65:24 (4000 × 1480)																
L 5:4 (7744 × 6192)	S 5:4 (3744 × 3000)																
L 7:6 (7232 × 6192)	S 7:6 (3504 × 3000)																
RAW (8256 × 6192)	TIFF (8256 × 6192)																
Lens mount	FUJIFILM G mount																
Sensitivity	<ul style="list-style-type: none"> • Still pictures: Standard output sensitivity equivalent to ISO 100–12800 in increments of 1/3 EV; AUTO; extended output sensitivity equivalent to ISO 50, 25600, 51200, or 102400 • Movies: Standard output sensitivity equivalent to ISO 200–6400 in increments of 1/3 EV 																
Metering	256-segment through-the-lens (TTL) metering; MULTI, SPOT, AVERAGE, CENTER WEIGHTED																
Exposure control	Programmed AE (with program shift); shutter-priority AE; aperture-priority AE; manual exposure																
Exposure compensation	<ul style="list-style-type: none"> • Still pictures: –5 EV–+5 EV in increments of 1/3 EV • Movies: –2 EV–+2 EV in increments of 1/3 EV 																

System

Shutter speed	Mode P	Other modes	Time	Bulb
MECHANICAL SHUTTER E-FRONT CURTAIN SHUTTER	4 s to 1/4000 s	60 min. to 1/4000 s	60 min. to 1/4000 s	Max. 60 min.
ELECTRONIC SHUTTER MECHANICAL + ELECTRONIC E-FRONT CURTAIN + ELECTRONIC	4 s to 1/16000 s	60 min. to 1/16000 s	60 min. to 1/16000 s	Max. 60 min.

Continuous	<ul style="list-style-type: none"> • Available frame advance rates (JPEG): 3.0 fps • Approximate maximum number of shots per burst: 25 <p> The frame rate varies with shooting conditions and the number of images recorded. In addition, the frame rate and number of frames per burst may vary depending on the type of memory card used.</p>
Focus	<ul style="list-style-type: none"> • Mode: Single or continuous AF; manual focus with focus ring • Focus-area selection: SINGLE POINT, ZONE, WIDE/TRACKING • Autofocus system: TTL contrast-detect
White balance	Custom 1, Custom 2, Custom 3, color temperature selection, auto, direct sunlight, shade, daylight fluorescent, warm white fluorescent, cool white fluorescent, incandescent, underwater
Self-timer	Off, 2 sec., 10 sec.
Flash mode	<ul style="list-style-type: none"> • MODE: TTL MODE (FLASH AUTO, STANDARD, SLOW SYNC.), MANUAL, MULTI, OFF • SYNC. MODE: 1ST CURTAIN, 2ND CURTAIN, AUTO FP(HSS) • RED EYE REMOVAL:  FLASH+REMOVAL,  FLASH,  REMOVAL, OFF
Hot shoe	Accessory shoe with TTL contacts; supports sync speeds as fast as 1/125 s
Sync contact	X contact; supports sync speeds as fast as 1/125 s
Sync terminal	Provided

System

Viewfinder	EVF-GFX1 interchangeable electronic viewfinder (supplied)	
LCD monitor	<ul style="list-style-type: none"> • Rear monitor: 3.2-in/8.1 cm, 2360k-dot color LCD touch screen with 3-way tilt • Shoulder monitor: 1.28-in/3.25 cm, 128 × 128-dot memory LCD monitor 	
Movies (with stereo sound)	 1080/29.97P	 720/29.97P
	 1080/25P	 720/25P
	 1080/24P	 720/24P
	 1080/23.98P	 720/23.98P

Input/output terminals

Microphone connector	ø3.5 mm mini-stereo jack
Headphone	ø3.5 mm mini-stereo jack
Digital input/output	USB3.0 High-Speed; Micro USB connector (Micro-B)
HDMI output	HDMI Micro connector (type D)
Remote release connector	ø2.5 mm 3-pole mini jack
DC IN	Provided

Power supply/other

Power supply

- NP-T125 rechargeable battery (supplied with camera)
- AC-15V AC adapter (available separately)

Battery life

- **Battery type:** NP-T125
- **Photographs:** The number of frames varies with the option selected for **AUTO POWER SAVE**:

Camera battery alone		
AUTO POWER SAVE	LCD	EVF
ON	Approx. 400	Approx. 400
OFF	Approx. 340	Approx. 340

With battery grip		
AUTO POWER SAVE	LCD	EVF
ON	Approx. 800	Approx. 800
OFF	Approx. 660	Approx. 660

- **Movies:** The length of footage that can be recorded varies with the movie mode:

Mode	Actual Battery life of movie capture	Continuance Battery life of movie capture
	Approx. 145 minutes	Approx. 70 minutes

CIPA standard, measured in mode **P**, using fully charged battery (NP-T125), GF63mmF2.8 R WR lens, and SD memory card.

Note: Battery life varies with battery charge level and will decline at low temperatures.

Camera size

(W × H × D)

147.5 mm × 94.2 mm × 91.4 mm (41.6 mm excluding projections, measured at thinnest part)/5.81 in. × 3.71 in. × 3.60 in. (1.64 in.)

Camera weight

Approx. 740 g/26.1 oz., excluding battery, accessories, and memory card

Shooting weight

Approx. 825 g/29.1 oz., including battery and memory card

Operating conditions

- **Temperature:** -10 °C to +40 °C/+14 °F to +104 °F (+5 °C to +40 °C/41 °F to 104 °F when battery is charging)
- **Humidity:** 10% to 80% (no condensation)

Wireless transmitter**Standards** IEEE 802.11b/g/n (standard wireless protocol)**Operating frequency** 2,412 MHz–2,462 MHz (11 channels)**Access protocols** Infrastructure**EVF-GFX1 interchangeable electronic viewfinder****Type** OLED**Size** 0.5-in/1.3 cm**Pixel count** Approximately 3.69 million dots**Magnification** 0.85× with 50 mm lens (35 mm format) at infinity and diopter set to -1.0 m^{-1} **Diagonal angle of view** Approximately 40° (horizontal angle of view approximately 33°)**Diopter adjustment** -4 to $+2 \text{ m}^{-1}$ **Eye point** Approximately 23 mm**Dimensions** 53.6 mm × 36.4 mm × 80.1 mm/2.11 in. × 1.43 in. × 3.15 in. (W × H × D)**Weight** Approx. 95 g/3.35 oz.**NP-T125 rechargeable battery****Nominal voltage** 10.8 V**Nominal capacity** 1250 mAh**Operating temperature** -10°C to $+40^\circ\text{C}/+14^\circ\text{F}$ to $+104^\circ\text{F}$ **Dimensions** 36.0 mm × 54.4 mm × 26.0 mm/1.4 in. × 2.1 in. × 1.0 in. (W × H × D)**Weight** Approx. 81 g/2.9 oz.

BC-T125 battery charger

Rated input	100V – 240V AC, 50/60 Hz
Input capacity	23 – 31 VA
Rated output	12.6V DC, 800 mA
Supported batteries	NP-T125 rechargeable batteries
Charging time	Approx. 140 minutes (+25 °C/+77 °F)
Operating temperature	+5 °C to +40 °C/+41 °F to +104 °F
Dimensions (W × H × D)	71.4 mm × 97.0 mm × 34.2 mm/2.8 in. × 3.8 in. × 1.4 in., excluding projections
Weight	Approx. 120 g/4.2 oz.

Weight and dimensions vary with the country or region of sale. Labels, menus, and other displays may differ from those on the actual camera.

 Specifications and performance are subject to change without notice. FUJIFILM will not be held liable for any errors this manual may contain. The appearance of the product may differ from that described in this manual.

FUJIFILM

FUJIFILM Corporation

7-3, AKASAKA 9-CHOME, MINATO-KU, TOKYO 107-0052, JAPAN

http://www.fujifilm.com/products/digital_cameras/index.html

